

T5183

TIP, 3" IN, 4.0" OD DUAL OUT, T304

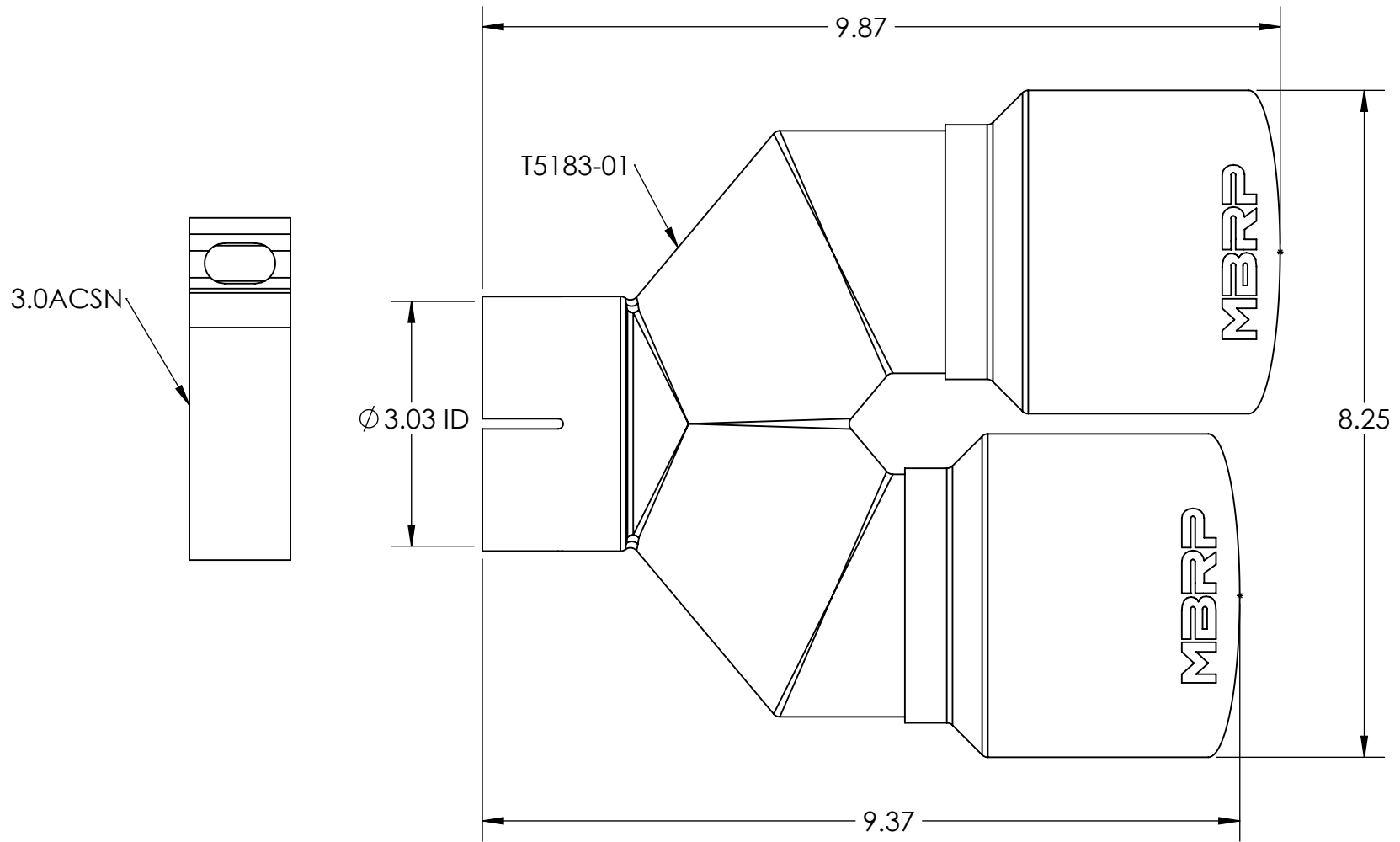

ITEM NO.	PART NUMBER	DESCRIPTION	T5183 /QTY.
1	T5183-01	TIP, 3" IN, 4.0" OD DUAL OUT, T304	1
2	3.0ACSN	CLAMP, 3.0", BAND ACCSEAL	1

13 November, 2020
REV:A

MBRP