



INSTALLATION GUIDE: AWE EXHAUST SUITE FOR BMW F8X M3 / M4

For up-to-date fitment information, please visit the product page on [AWE-Tuning.com](https://www.awe-tuning.com).

THIS GUIDE IS INTENDED FOR THE FOLLOWING PART NUMBERS:

- 3020-42082 AWE Track Edition Exhaust for F8X BMW - Quad Chrome Silver Tips
- 3020-43087 AWE Track Edition Exhaust for F8X BMW - Quad Diamond Black Tips
- 3025-42070 AWE Switchpath Edition Exhaust for F8X BMW - Quad Chrome Silver Tips
- 3025-43074 AWE Switchpath Edition Exhaust for F8X BMW - Quad Diamond Black Tips

Welcome to the AWE family, and congratulations on your purchase of the AWE Exhaust System for the BMW F8X M3/M4.

Exquisite build quality and craftsmanship, coupled with industry leading performance, distinguish this exhaust system from all others.

*For up to the minute fitment information, be sure to visit the AWE website. As always, AWE Performance Specialists are standing by for any questions, [right here](#).

PARTS LIST (SWITCHPATH SYSTEMS)



Inspect **ALL** parts prior to disassembly of vehicle; If damaged or **MISSING**, please contact the place of purchase immediately.

Symbol	Part Number	Description	QTY
	D89	BMW F8X M3-M4 X-Pipe Section	1
	D90	BMW F8X M3-M4 Diff Leg Driver Side	1
	D91	BMW F8X M3-M4 Diff Leg Passenger Side	1
	D92	BMW F8X M3-M4 SwitchPath Valve Section Driver Side	1
	D93	BMW F8X M3-M4 SwitchPath Valve Section Passenger Side	1
	D94	BMW F8X M3-M4 SwitchPath Chamber Assembly	1
A >>		Clamp Kit	1
B >>		2.5" Accu-Seal Stainless Steel Band Clamp	2
C >>		3.0" Accu-Seal Stainless Steel Band Clamp	6
D >>		BMW F8X Chassis Brace	1
E >>		AWE 4" Chrome Tip	4
		AWE 4" Black Chrome Tip	4

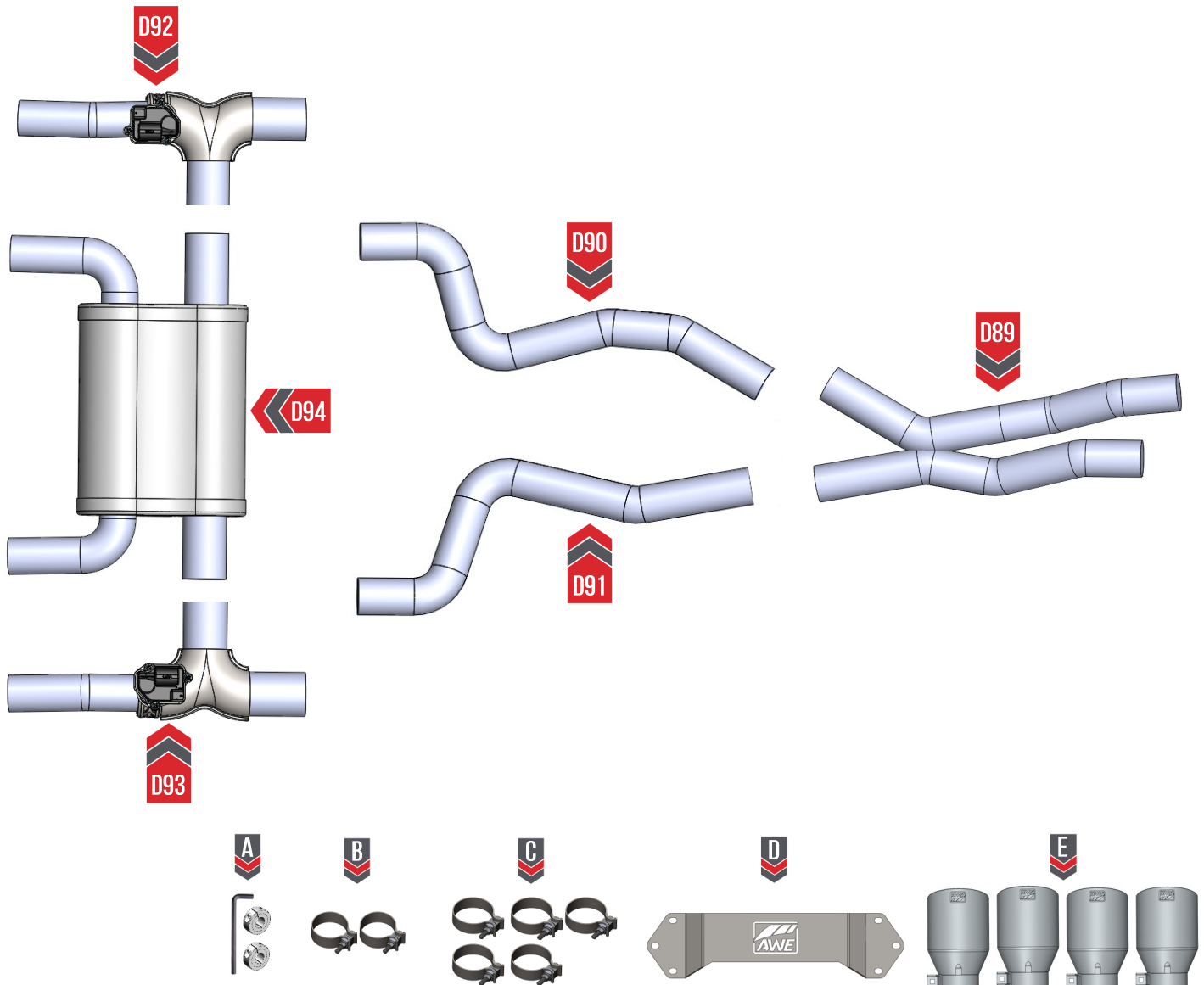

PARTS LIST (TRACK SYSTEMS)



Inspect **ALL** parts prior to disassembly of vehicle; If damaged or **MISSING**, please contact the place of purchase immediately.

Symbol	Part Number	Description	QTY
	D89	BMW F8X M3-M4 X-Pipe Section	1
	D90	BMW F8X M3-M4 Diff Leg Driver Side	1
	D91	BMW F8X M3-M4 Diff Leg Passenger Side	1
	D95	BMW F8X M3-M4 Track Rear Assembly	1
A >>		Clamp Kit	1
B >>		2.5" Accu-Seal Stainless Steel Band Clamp	2
C >>		3.0" Accu-Seal Stainless Steel Band Clamp	4
D >>		BMW F8X Chassis Brace	1
E >>		SBS Valve Motor Simulator	2
F >>		416 Stainless Steel Dowel Pins, 7/64" Diameter, 1" Long	2
G >>		AWE 4" Tips Chrome	4
		AWE 4" Black Chrome Tip	4

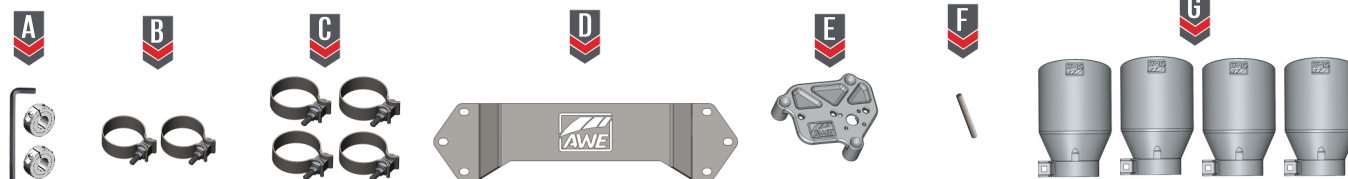
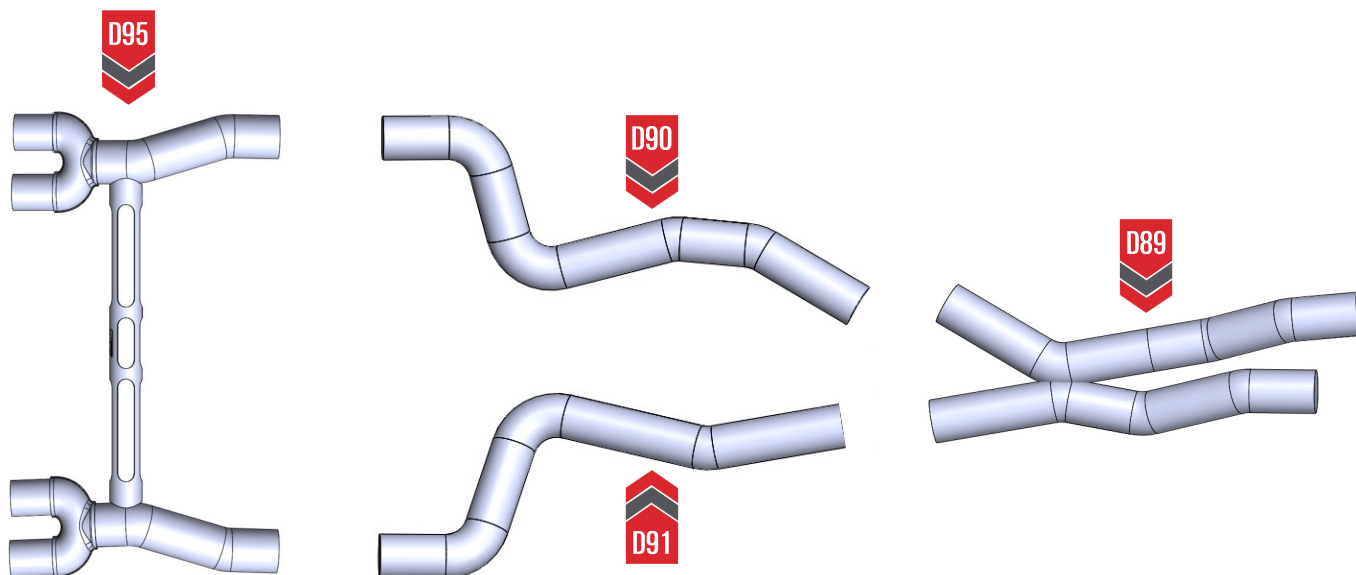



NOTE: Always refer to the manufacturer's service manual for precise torque specifications on all OEM fasteners.



CAUTION: The exhaust may be **VERY HOT** — allow adequate time for the system to cool down before disassembly. Severe burns and injury will occur if skin comes into contact with a hot exhaust system.



COMPLETE THIS PROCESS BEFORE MOVING FORWARD



Before starting installation, the factory exhaust valves must be in the open position. Bring the engine up to full operating temperature. With the engine running, press the Engine Dynamics button to switch into Sport-Plus mode. Blip the throttle to audibly confirm the valves are open. If in doubt of valve position, peer into the exhaust tips with a flashlight to confirm that they are open. While still in Sport-Plus mode, shut off engine. Disconnect the connectors from both valve electrical motors. Allow exhaust to cool before proceeding with next install steps. **Failure to follow this procedure will result in the factory valve motors not aligning with the AWE Tuning exhaust valves.**

STEP 1

Begin by removing the OE bolts mounting the OE chassis brace to the body, as shown in **Figure 1**.

Note: The OE hardware will be reused with the install of your AWE exhaust.

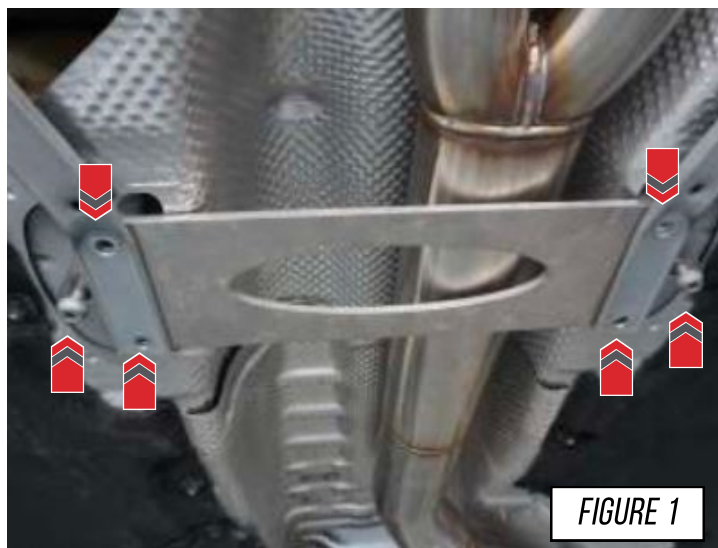

FIGURE 1

STEP 2

On the driver side catalytic converter measure **4.50"** inches from the weld seam (**A**) towards the rear of the vehicle.

Mark with tape (**B**) and an arrow pointing to the rear of the vehicle, as shown in **Figure 2**.



It is extremely important that these measurements are accurate as it will effect fitment.



FIGURE 2

STEP 3

On the passenger side catalytic converter measure **7.00"** inches from the weld seam (**A**) towards the rear of the vehicle.

Mark with tape (**B**) and an arrow pointing to rear of the vehicle, as shown in **Figure 3**.



It is extremely important that these measurements are accurate as it will effect fitment.

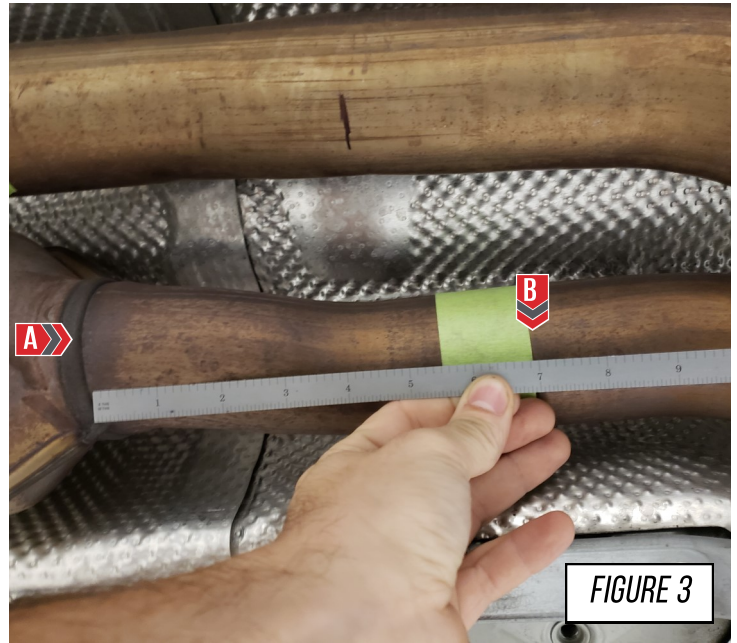

FIGURE 3

STEP 4

Make a cut on the driver and passenger side exhaust tube along the rear edge of the tape, as shown in **Figure 4-1** and **Figure 4-2**.

NOTE: It is crucial that these cuts are accurate. Incorrect cuts will effect fitment.



Make sure that the cuts are perpendicular to the tube you are cutting.

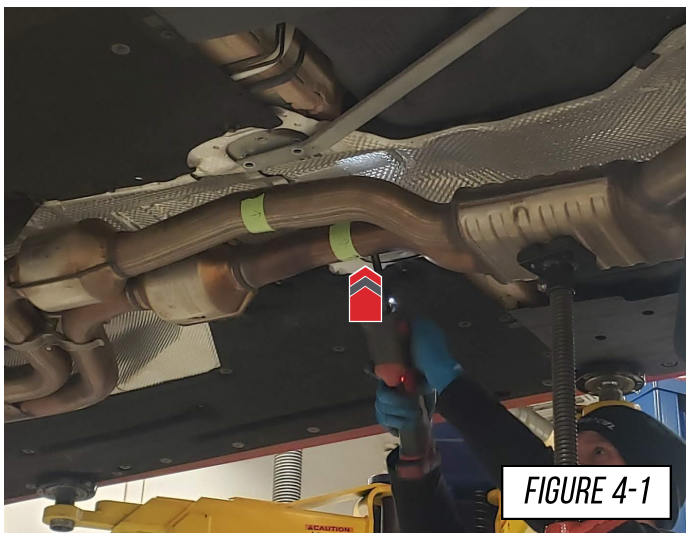

FIGURE 4-1

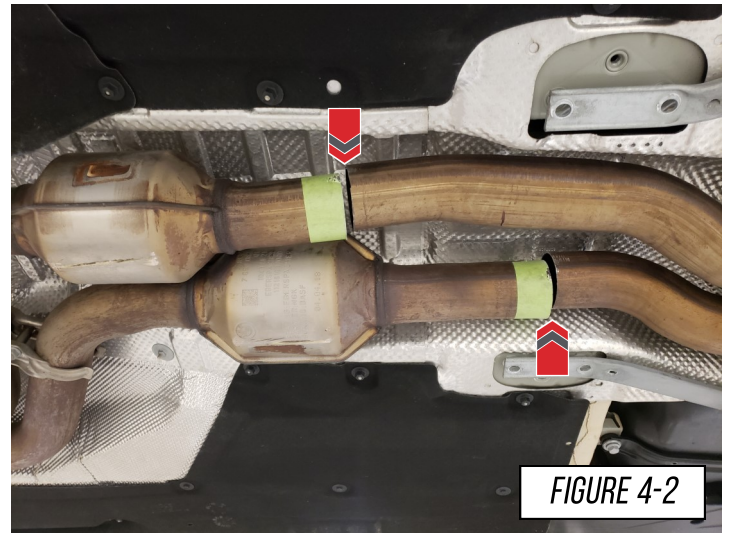

FIGURE 4-2

STEP 5



Before starting Step 5 ensure you have completed the process in the note before Step 1. Failure to do this can cause misalignment in the valve motors

Unplug the 2 OE valve motors (A).

Remove the bolts mounting the 4 hangers to the body (B), as shown in **Figure 5**.

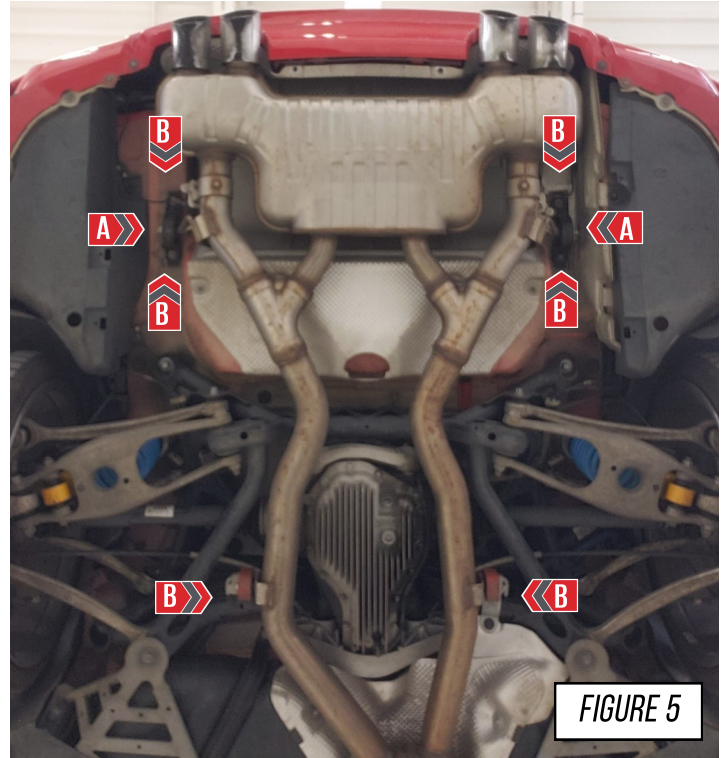

FIGURE 5

STEP 6

Once the hangers are free, remove the OE exhaust system, as shown in **Figure 6-1** and **6-2**.

With your OE exhaust system removed, uninstall the OE valve motors as well as their respective springs and bolts from the factory brackets, mark the driver and passenger and set them aside. You will reuse them in later steps.



FIGURE 6-1

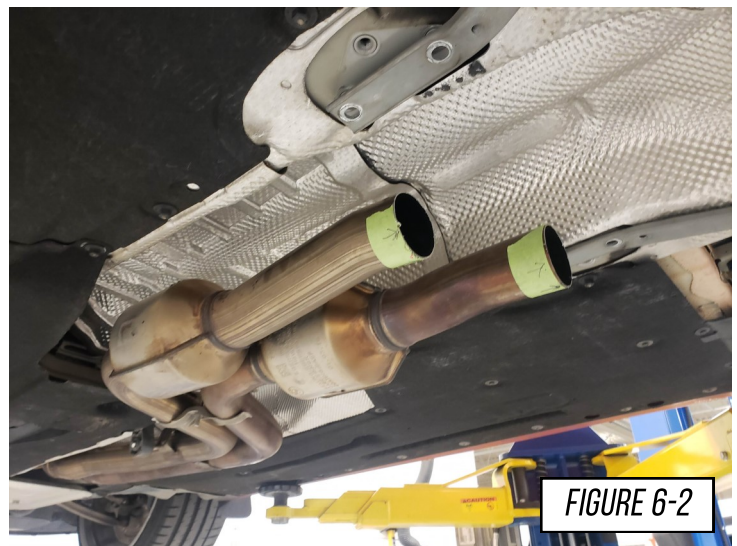

FIGURE 6-2

STEP 7

Deburr the edges of the OE exhaust tubes you just cut, as shown in **Figure 7**.

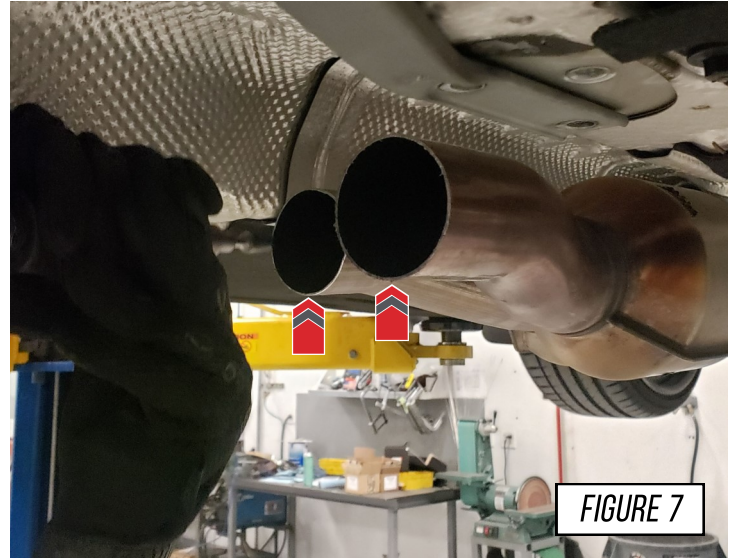

FIGURE 7

STEP 8

Begin installing your AWE system by, sliding your AWE X-pipe section (**D89**), with the supplied Accu-Seal clamps, over the cut section, as shown in **Figure 8**.

Note: The OE pipe clamp just before the cats can be loosened to help align the OE pipes and the AWE x-pipe.

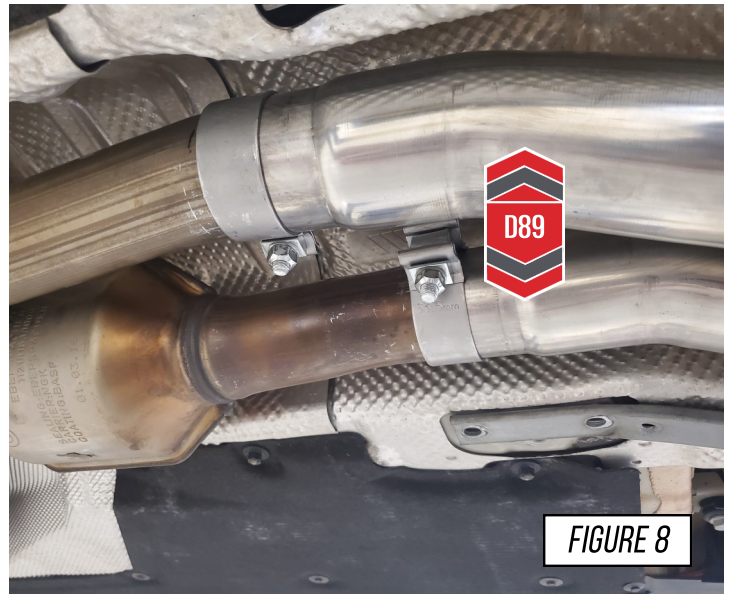

FIGURE 8

STEP 9

It is crucial to install each section and exhaust band clamps correctly to prevent loose joints, exhaust leaks and rattles.

Arrow A shows the expanded pipe and the preinstalled exhaust clamp being brought up to the corresponding pipe.

Arrow B shows the overlapping pipe installed correctly over the corresponding pipe.

Arrow C shows the exhaust band clamp being brought to the edge of the expanded pipe.



NOTES:

- **Do not** fully torque any exhaust clamp until the entire exhaust has been installed and adjusted.
- Torque specification is a **minimum** of 60 ft/lbs

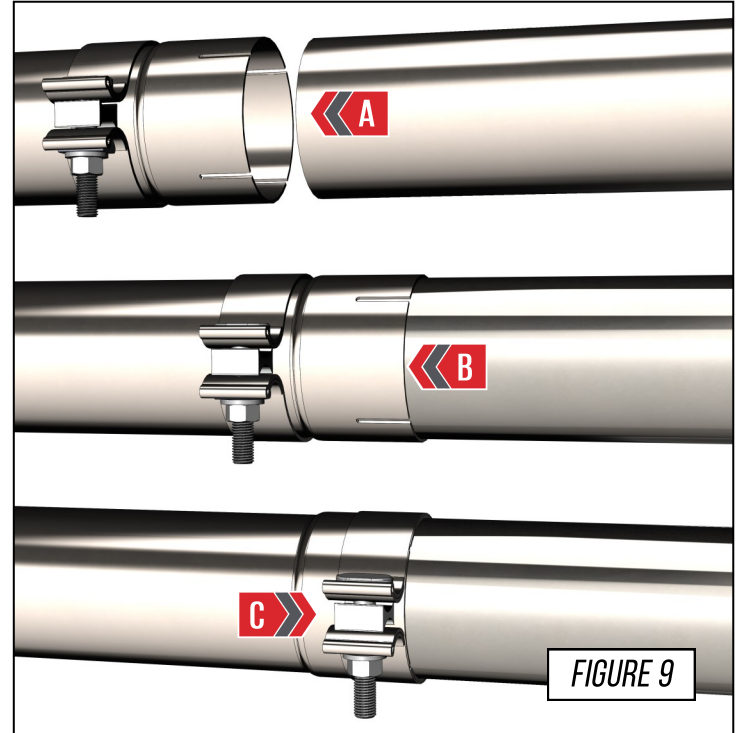

STEP 10

Install your AWE driver side differential pipe (D90), with the supplied Accu-Seal clamp, as shown in **Figure 10**.



STEP 11

Install your AWE driver side differential pipe (D90) using the OE hanger removed earlier, as shown in **Figure 11**.

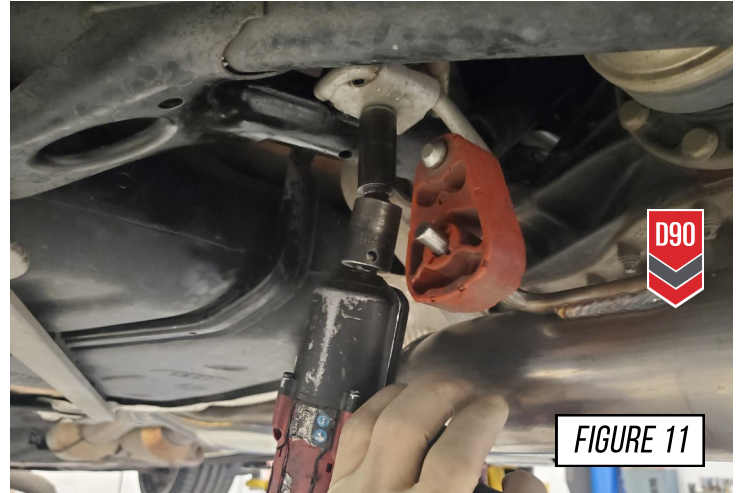

STEP 12

Install your AWE passenger differential pipe (D91), with the supplied Accu-Seal clamp (A), as shown in **Figure 12**.

NOTE: Reinstall the passenger side hanger (B) removed earlier.

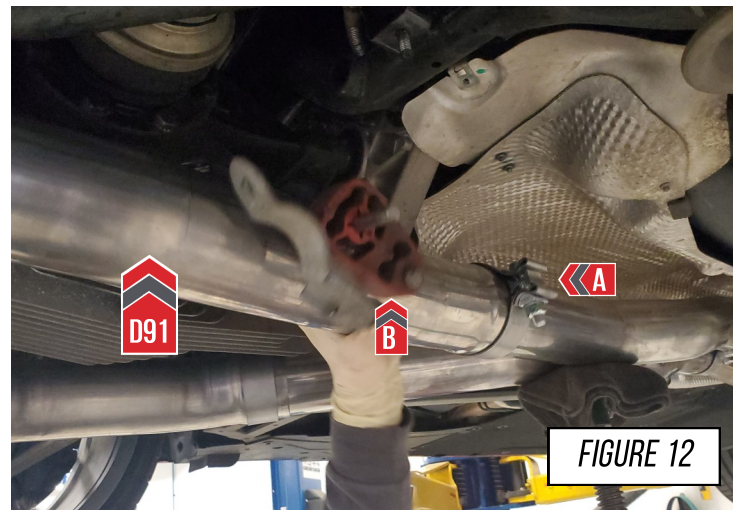



IF INSTALLING AWE TRACK EDITION SYSTEM, SKIP TO STEP 19.



STEP 13

Install the provided valve spring (A) onto your OE valve, as shown in **Figure 13-1**.

Next install the OE valve motor (B), as shown in **Figure 13-2**.

Last check to make sure the valve motor and spring are sitting (C), as shown in **Figure 13-3**.

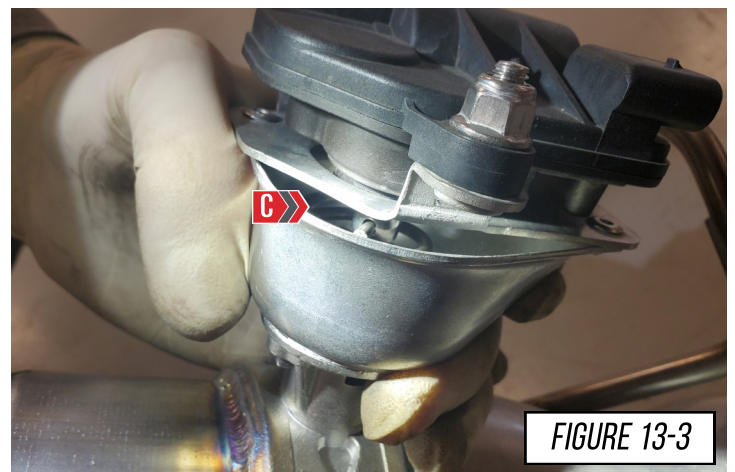
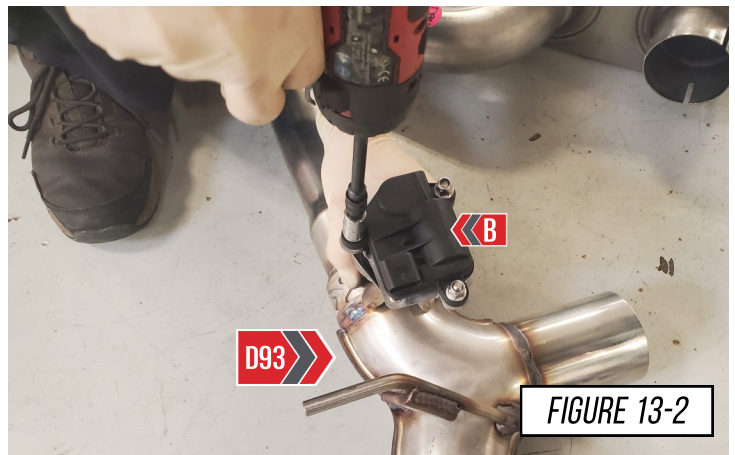
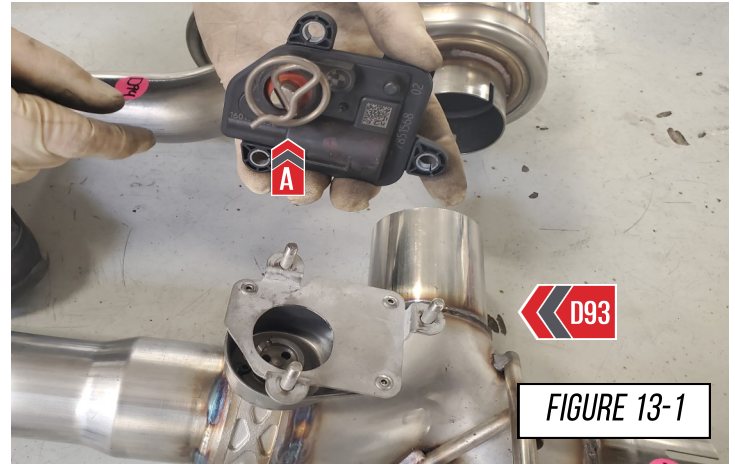

Repeat this process for your AWE valve section, on the driver side (D92).



STEP 14

Install your AWE valve sections (**D92** and **D93**), with the supplied Accu-Seal clamp, onto your AWE muffler assembly (**D94**), as shown in **Figure 14-1** and **14-2**.

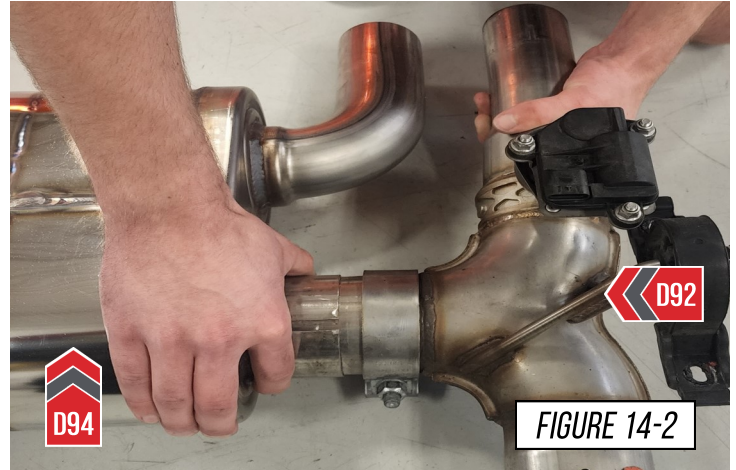
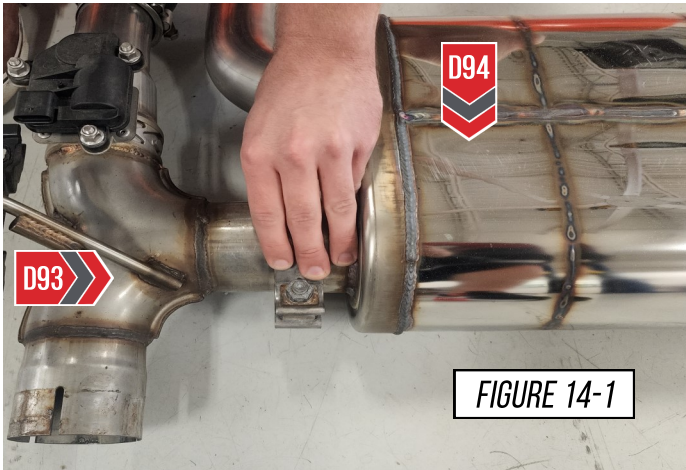

STEP 15

Attach the OE rear hangers on both sides of your AWE rear muffler, as shown in **Figure 15**.

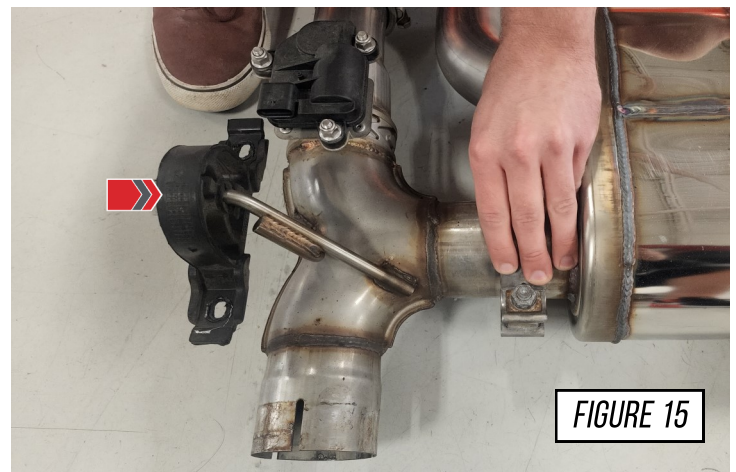

STEP 16

Install your AWE muffler assembly (**D92/D93/D94**), with the supplied Accu-Seal clamps, onto the AWE differential pipes, as shown in **Figure 16-1** and **Figure 16-2**.

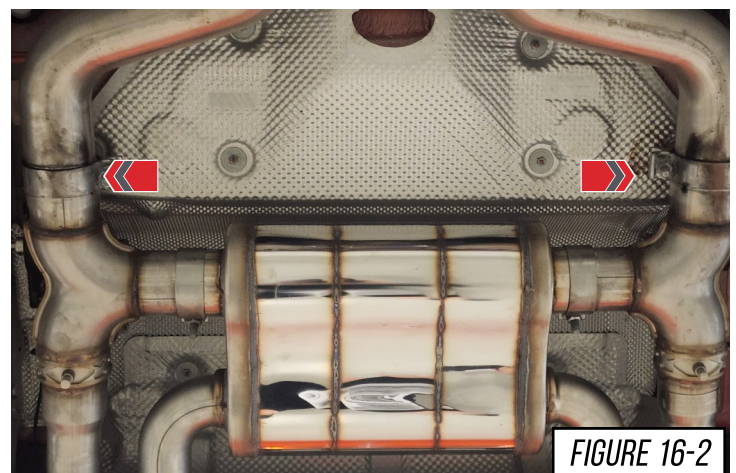
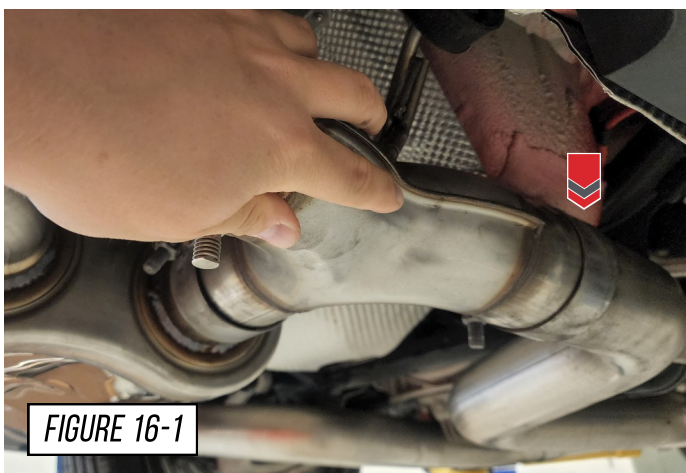

STEP 17

Reinstall the hardware into the OE rear hangers (A), as shown in **Figure 17-1**.

Plug the OE connector into the valve motor, shown by (B).

Note: Unclip to OE harness from the chassis on both the driver and passenger sides to allow the harness to reach the AWE pipes, as shown in **Figure 17-2** and **17-3**.

Note: Do so on both the driver and passenger side.

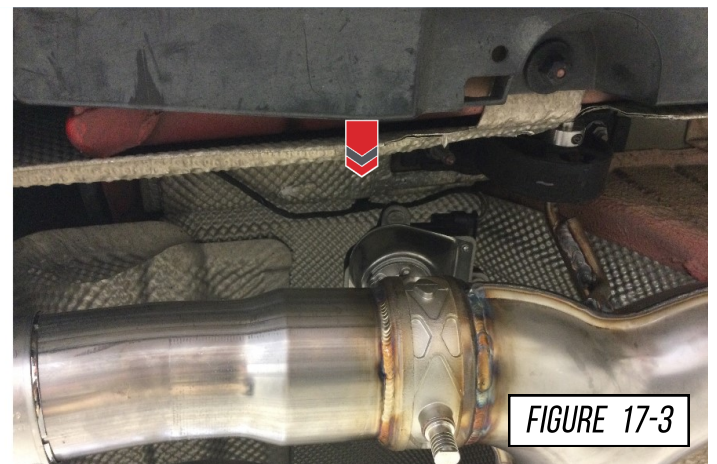
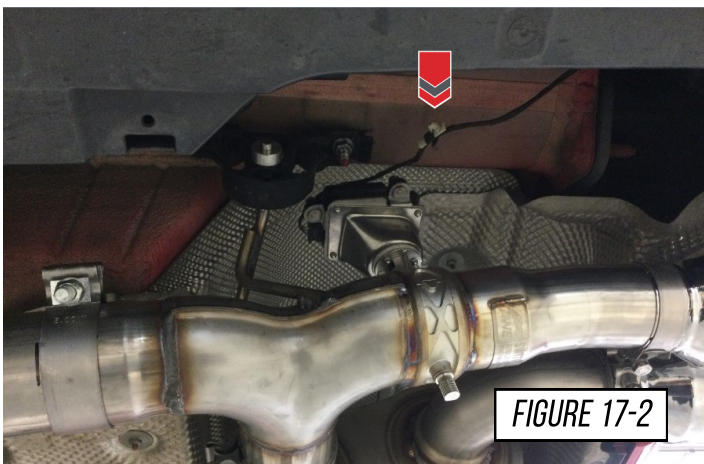
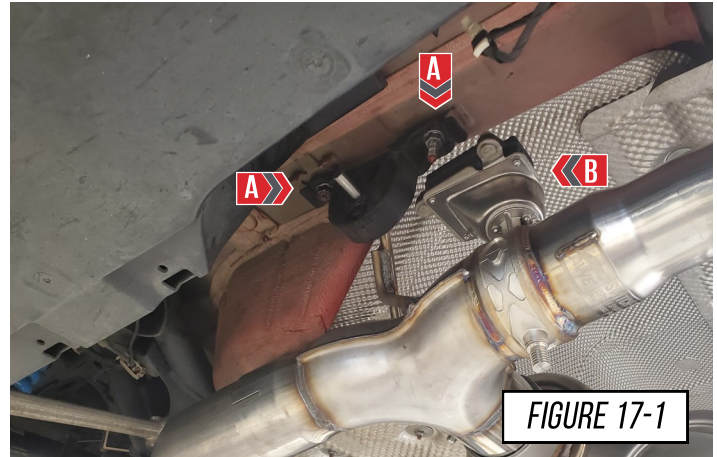

STEP 18

For the rear sections, hanger bar collar clamps are provided to prevent side to side movement of the exhaust system. After sliding the exhaust hanger bar through the OEM grommet, install the collar clamp on the outside end of the bar as shown in **Figure 18**.

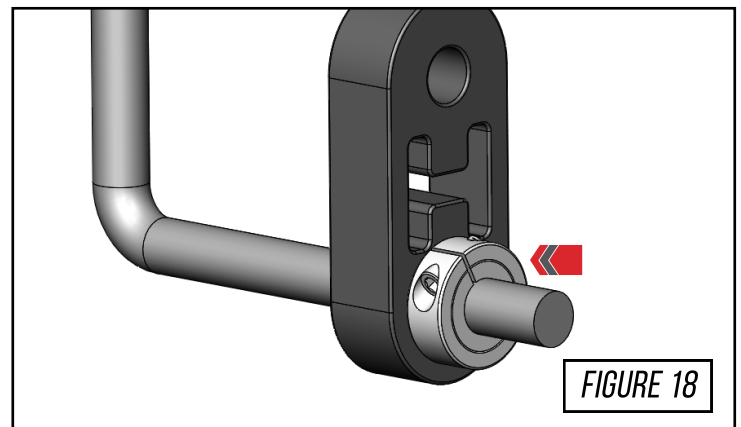

AWE SWITCHPATH SYSTEM, SKIP TO STEP 25.



STEP 19

AWE Track System **ONLY**.

Install your AWE Track rear assembly (**D95**), with the supplied Accu-Seal clamps and OE hangers, onto the AWE differential pipes, as shown in **Figure 19**.

NOTE: Wait to install exhaust tips, until later in your installation.

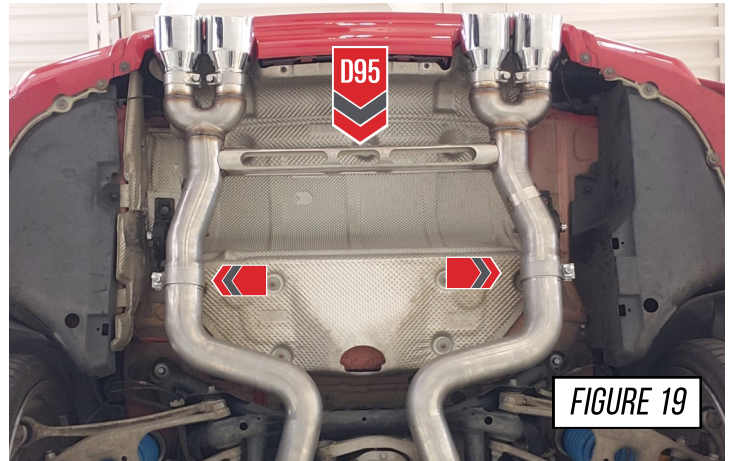

STEP 20

Reinstall the OE rear hangers, as shown in **Figure 20**, on both the driver and passenger side.

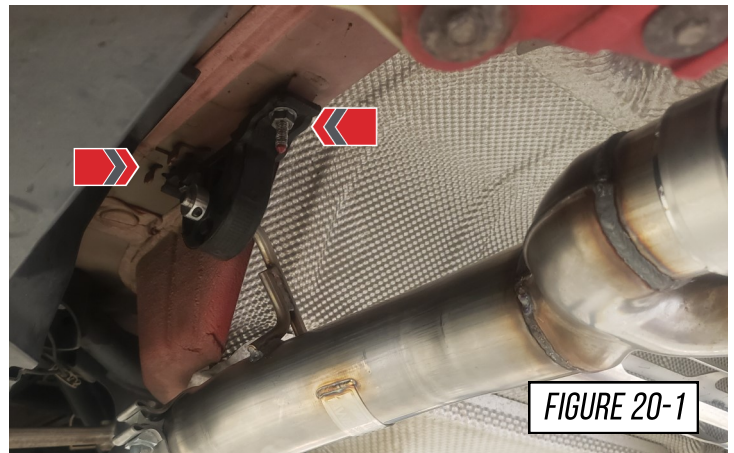

STEP 21

For the rear sections, hanger bar collar clamps are provided to prevent side to side movement of the exhaust system. After sliding the exhaust hanger bar through the OEM grommet, install the collar clamp on the outside end of the bar as shown in **Figure 21**.

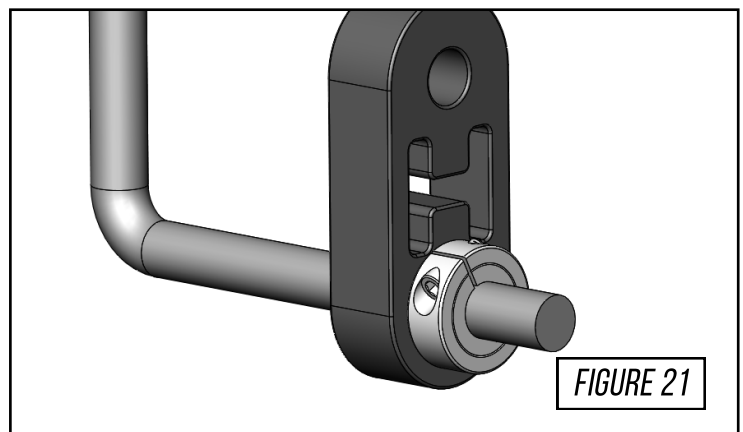

STEP 22

Attach your OE valve motor to the AWE valve motor simulator bracket.

Start by installing the dowel pin, as shown in **Figure 22-1**.

Next install the OE valve motor on the simulator bracket, keeping the dowel aligned, as shown in **Figure 22-2**.

Last install the OE bolts removed earlier, as shown in **Figure 22-3**.

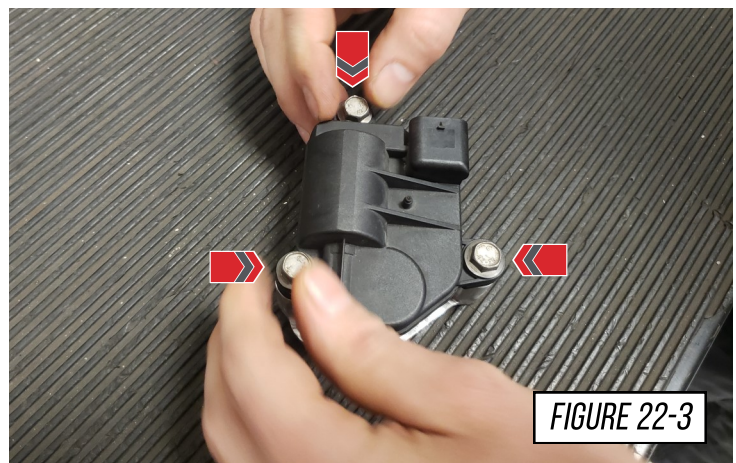
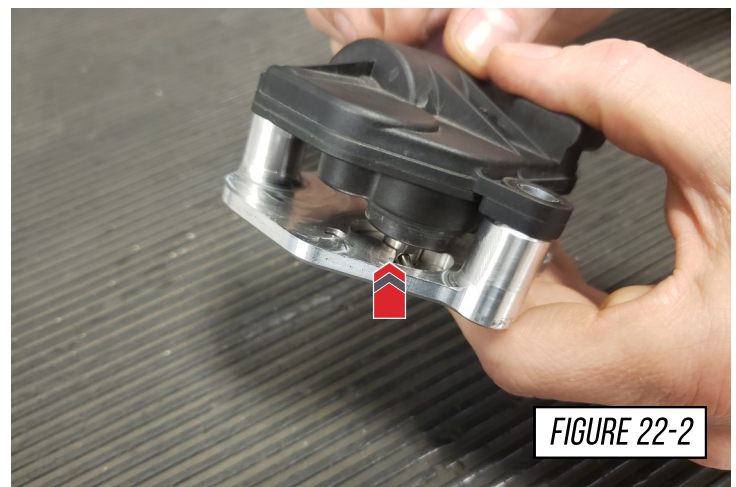
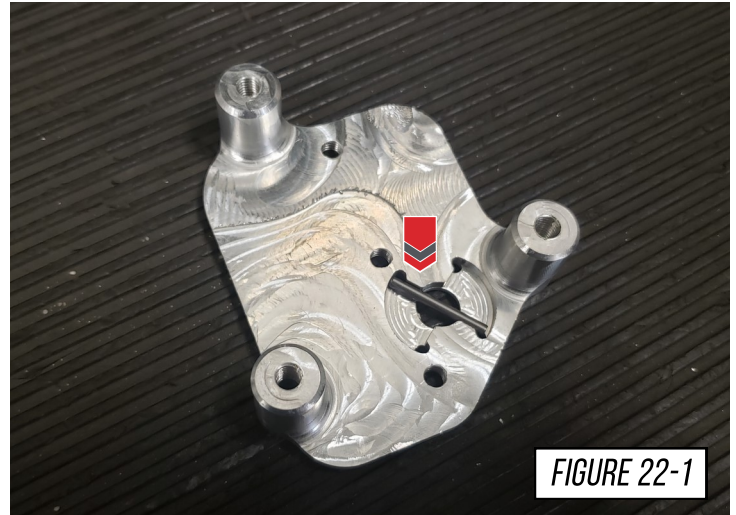

STEP 23

With the valve motor simulators assembled, plug them into the OE connection on the driver side before tucking them into a pocket in the body, as shown in **Figure 23**.



STEP 24

Plug one of your valve motors into the OE connection on the passenger side before tucking it behind the heat shield in the bumper, as shown in **Figure 24-1** and **Figure 24-2**.



STEP 25

Install your AWE chassis brace, using the OE hardware, as shown in **Figure 28**.



Ensure you have torqued down the 2 clamps connecting your new AWE system to the OE tubes before this step.

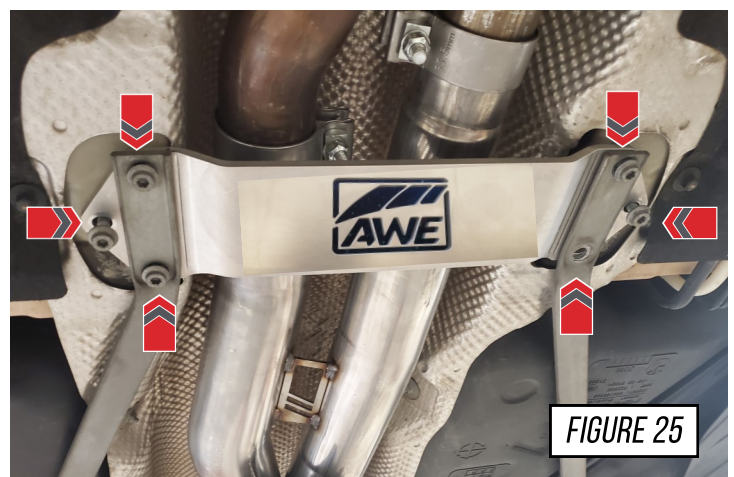

STEP 26

Install all 4 AWE exhaust tips and hardware onto the tip outlets, as shown in **Figure 26**.

Note: Only snug clamps at this time.

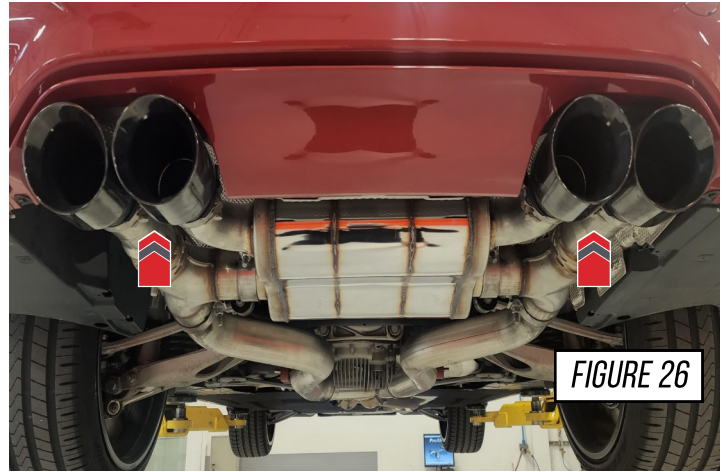

FIGURE 26

STEP 27

To install the exhaust tips with integrated clamps, first, attach the exhaust tip in the proper orientation onto the exhaust outlet tube.

Insert one of the carriage bolts from the hardware kit (**3910-41010**) through the tab on the exhaust tip and thread on one of the corresponding nuts.

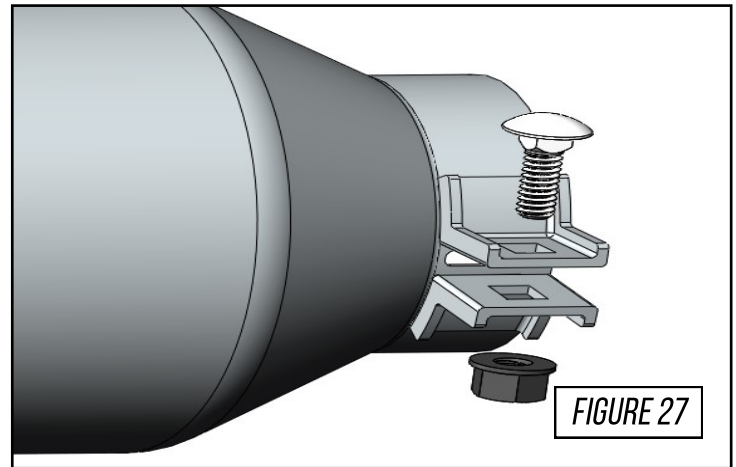

FIGURE 27

STEP 28

With all AWE exhaust components installed, go ahead and torque down the clamps on the entire system, working from the front of the car to the exhaust tips.

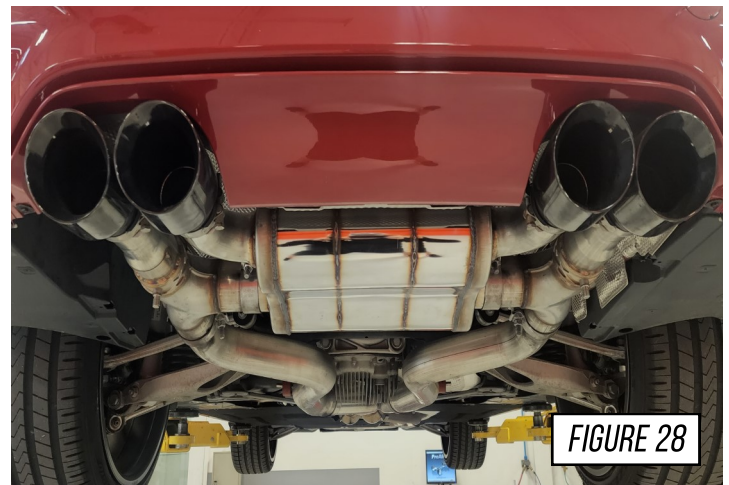

FIGURE 28

ENJOY!



TROUBLESHOOTING

Issue	Solution
Exhaust is not fitting correctly	Most fitment issues are due to improperly adjusted exhaust. This includes tip fitments and rattling due to chassis contact. Check out our fitment guide for more installation tips.
Wrong or missing parts	Double check the parts list for your system and compare them with what you received. Fill out our contact form, found below and let us know what parts you need.

CARE

Once installed properly, your AWE exhaust will provide years of trouble-free performance.

The exhaust volume and sound will settle with usage; 800-1000 miles is required to break-in new exhaust systems.

Also, please note that the rear **180Technology®** resonator has a small drain hole to allow condensation to escape. Water drops from this area are normal.

Periodic cleaning of exhaust tips is necessary to maintain proper finish, especially in areas prone to road salt and caustic deicing solutions. Use a mild soap and water solution or car wax to clean the finish. Avoid using abrasive polishes, as they can scratch the finish.

Any questions or comments,
please do not hesitate to contact us:

AWE

215-658-1670

[**CONTACT FORM**](#)

WARRANTY

Up-to-date warranty information is found [HERE](#).