



**IMPORTANT WARRANTY & INSTALLATION
INSTRUCTIONS ATTACHED**

*Please Forward All Attached Information to Consumer
Warranty Not Valid Unless Returned to CORSA Exhaust*

We ask that you take a few moments to complete our warranty registration form:

TO ACTIVATE YOUR LIMITED LIFETIME WARRANTY GO TO:
CORSAPERFORMANCE.COM/WARRANTY



**For Full-Color Installation Instructions, Please Visit:
CORSAPERFORMANCE.COM and Search by Part Number**

Please be sure to review the enclosed instructions prior to beginning the installation process. If you have any questions about the enclosed parts, instructions or encounter a problem during installation:
CALL CORSA PERFORMANCE TECHNICAL ASSISTANCE AT 800.486.0999

Please take time to read and understand these installation instructions.

CORSA recommends that the installation of this system be performed by a qualified service center or professional muffler installer who has the necessary equipment, tools and experienced personnel. However, if you decide to perform this install, the use of a hoist and an additional person will be required.

CAUTION: Never work on a hot exhaust system. Allow time for the vehicle to cool. Always wear eye protection when working under a vehicle.

Recommended Tools:

- 3/8" drive ratchet
- 3/8" drive long extension
- 3/8" drive 13mm socket
- 3/8" drive 15mm deep socket
- Grommet pullers
- Soap and water solution
- Torque Wrench
- Penetrating lubricant spray
- Safety glasses

Please confirm that all parts are present before beginning the factory exhaust system removal and CORSA exhaust system installation.

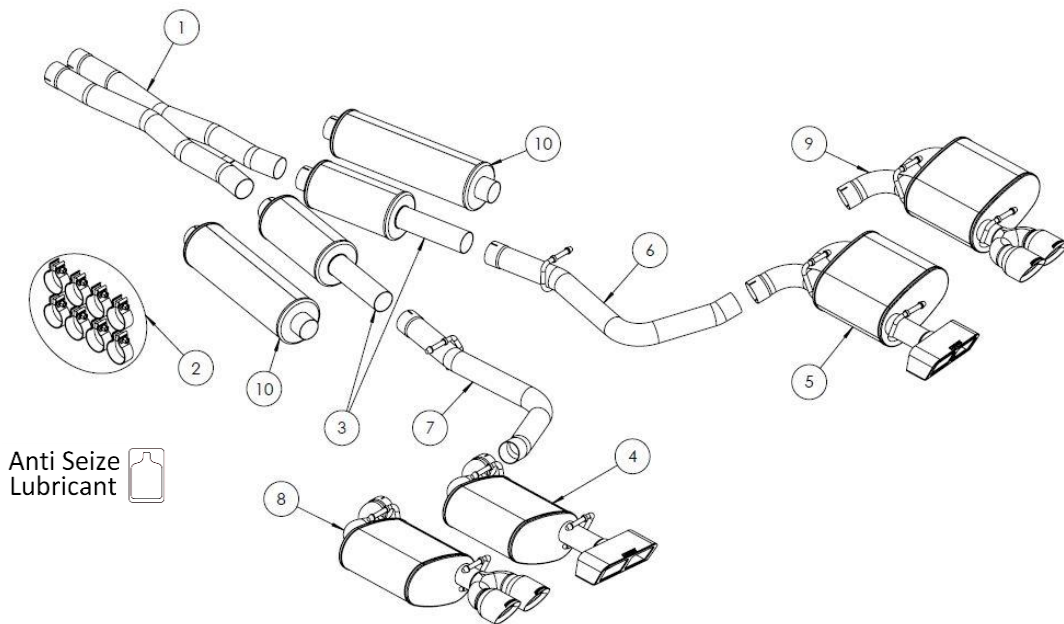

Bill of Materials

- | | |
|---|---|
| 1. 17CH4052 XO Pipe Assembly | 6. 18LC4001 Driver Axle Pipe Assembly |
| 2. 17CH7009 Hardware Kit | 7. 18LC4000 Passenger Axle Pipe Assembly |
| 3. 18LC2000 Xtreme Tunnel Muffler (2) (PNs: 14975, 14985) | 8. 18LC2045 Driver Rear Muffler Assembly (PNs: 14985, 14986) |
| 4. 18LC2011 Driver Rear Muffler Assembly (PNs: 14974, 14975) | 9. 18LC2046 Passenger Rear Muffler Assembly (PNs: 14985, 14986) |
| 5. 18LC2012 Passenger Rear Muffler Assembly (PNs: 14974, 14975) | 10. 19FL2000 Sport Tunnel Muffler (2) (PNs: 14974, 14986) |

Factory Exhaust System Removal:

1. Using grommet pullers or a similar device, remove the driver and passenger side stock axle pipe hangers from their corresponding hanger grommets. **(Fig. A)**

NOTE: The use of a soap and water solution may aid in the removal of hanger grommets.

2. Using a 3/8" ratchet and 13mm deep socket, remove the spring bolts at the driver side rear muffler flange connection. **(Fig. B)** Next, using the ratchet, long extension, and 13mm socket, unbolt both the front and rear driver side hanger grommet assemblies from the vehicle chassis. **(Fig. C & D)** The driver side muffler will no longer be supported and can be removed by sliding it rearward until the flange clears the studs, then lowering the muffler. **(Fig E)**
3. Using a 3/8" drive ratchet and 15mm deep socket, loosen the driver and passenger side clamps at the cat-back connection point. **(Fig. F)**
4. Remove the grounding wire clamp from the passenger rear muffler hanger. **(Fig. G)** Then, using a 3/8" ratchet and 13mm socket, long extension, unbolt the front and rear hanger grommet assemblies from the vehicle chassis. **(Fig. H)** The remaining portion of the stock exhaust can now be removed by sliding the system rearward to clear the overlapping pipe connection and the cat-back connection point; then lower the remaining portion of the stock exhaust system. **(Fig. I)**
5. Using grommet pullers or a similar device, remove the front and rear hanger grommet assemblies from the rear driver and passenger side mufflers. Make note of the hanger grommet assemblies' orientation as they will be installed in the same position on the Corsa Performance exhaust system. **(Fig. J)**

NOTE: The use of a soap and water solution may aid in the removal of hanger grommets.

REMOVAL PICTURES ON NEXT PAGE 

Factory Exhaust System Removal Pictures:



Fig. A

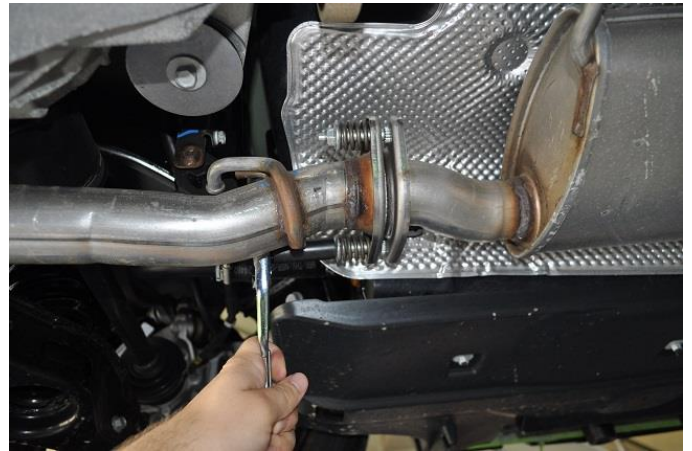

Fig. B



Fig. C



Fig. D



Fig. E



Fig. F

Factory Exhaust System Removal Pictures:



Fig. G



Fig. H



Fig. I

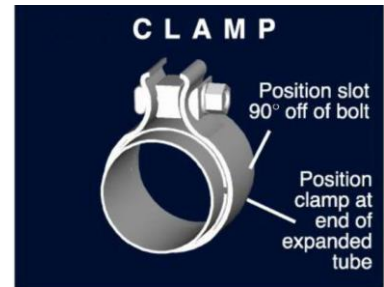

Fig. J

Installation of CORSA Exhaust System:

NOTE: Apply the anti-seize lubricant (supplied) to the threads **ONLY** of all the clamps and flange bolts. Failure to follow this procedure can cause nuts to seize on clamps and potentially destroy threads. After applying anti-seize lubricant, be sure to thoroughly clean your hands, as lubricant will tarnish stainless steel. All clamps should be tightened using a properly calibrated Torque Wrench. Using an air impact gun will damage the clamp and reduce its ability to effectively seal the joint. It may also cause the joint to separate, thereby causing damage to your exhaust system and to your vehicle.

NOTE: Align all clamps so that the center of the clamp bolt is 90 degrees from the notch in the pipe. (See Fig. CLAMP)



1. Remove all exhaust system components from the shipping boxes, including clamps and hardware.
2. Locate the XO pipe assembly and two 2.5" clamps. Install the clamps on the expanded inlet side of the XO assembly so that the bolts are horizontal with the nuts towards the outside of the vehicle. With the XO cross braces towards the bottom, slide the assembly over the stock exhaust pipes at the cat-back connection point. **(Fig. K)** Position the XO assembly so that it is parallel with the ground and snug the clamps using a 15mm deep socket and ratchet. **(Fig. L)**
3. Locate the two tunnel muffler assemblies along with two 2.5" clamps. Install the clamps on the expanded inlets of the tunnel mufflers. Position the driver side clamp so that the bolt is vertical with the nut towards the ground and the bolt towards the outside of the vehicle. Position the passenger side clamp so that the bolt is vertical with the nut towards the ground and the bolt towards the center of the vehicle. Slide the expanded inlet end of the tunnel muffler over the XO assembly outlet. **(Fig. M)** Using a 15mm deep socket and ratchet, snug both the driver and passenger side clamps. **(Fig. N)** Place a jack stand under each tunnel muffler for additional support during the rest of the install process.
4. Locate the driver and passenger side axle pipes along with two 2.5" clamps. Insert the axle pipe hangers into their corresponding grommets located just before the rear differential. **(Fig. O)** Install the clamps on the expanded inlet side of the axle pipe assemblies so that the bolts are vertical with the nuts towards the ground and the bolts towards the outside of the vehicle. Slide the expanded inlet end of the axle pipe assembly over the tunnel muffler outlet. Position the axle pipe assemblies so that the hangers are parallel with the ground and the hanger is swung forward. Snug both clamps using a 15mm deep socket and ratchet. **(Fig. P)**

NOTE: The use of a soap and water solution may make it easier to install the hangers.

INSTALLATION INSTRUCTIONS CONTINUED ON NEXT PAGE 

5. Locate the passenger side rear muffler, a 2.5" clamp, and the passenger side hanger grommet assemblies removed during step 5 of the stock exhaust removal process. Install the hanger grommet assemblies on their corresponding hangers in the same orientation as removed from the stock exhaust. **(Fig. Q)** Next, install the clamp on the expanded inlet end of the muffler assembly so that the bolt is vertical, with the nut towards the ground and the bolt towards the front of the vehicle. Slide the muffler inlet over the axle pipe outlet. **(Fig. R)** Using a 13mm socket, long extension, and ratchet, install the front hanger grommet assembly, reusing the stock bolt. **(Fig. S)** Swing the muffler assembly forward and install the rear hanger grommet assembly; again reusing the stock bolt. **(Fig. T)** Once the muffler is in place, snug the clap using the ratchet and 15mm socket. **(Fig. U)** Install the ground wire by clipping it to the stock hanger assembly and the hanger on the Corsa Performance rear muffler.
6. Repeat step #5 on the driver side of the vehicle.
7. Check that the clearance to the suspension mounts are the same on both sides. Adjust the position of the x-pipe and tunnel mufflers as needed to create equal and adequate clearance of the axle pipes and the rear suspension sub-frame. Make sure that the x-pipe is level and not rotated to one side, this will ease tip adjustment. Check clearance between the passenger side axle pipe and the spare tire well.
8. Adjust the system accordingly, including the rear muffler depth and rotation, so that the exhaust tip outlets are centered in the bumper exhaust cutouts. **(Fig. V)** Check clearance between the system components and chassis. At this time, tighten all clamps to 45ft-lbs using the torque wrench and 15mm socket.

NOTE: During cold weather start-ups, you may experience an exhaust sound that is deeper and louder in tone than usual. This is temporary and will diminish to normal levels once your engine has reached its normal operating temperature.

NOTE: Immediately following the installation of your exhaust system, you may experience a trace of smoke after initial start-up. DO NOT be alarmed. The smoke is caused by the burning of a small amount of forming oil residue used in the manufacturing process.

INSTALLATION PICTURES ON NEXT PAGE 

CORSA Installation Pictures



Fig. K

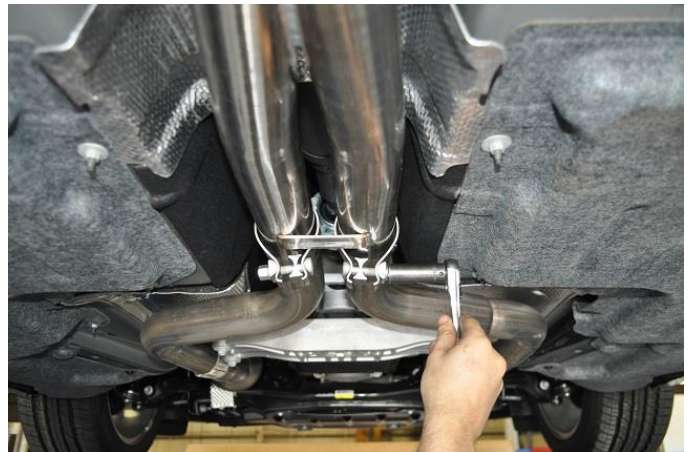

Fig. L

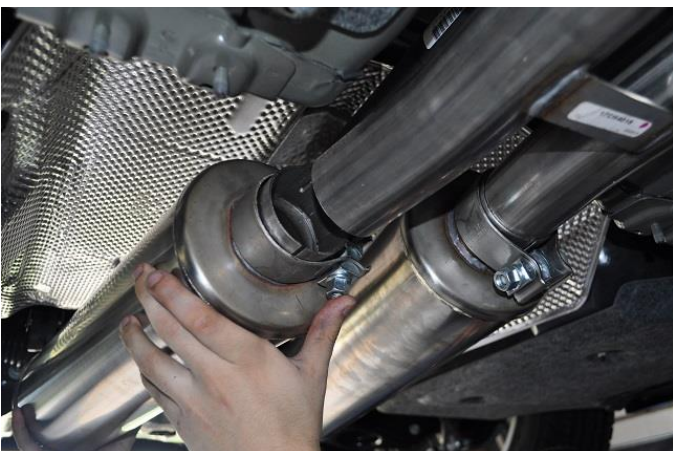

Fig. M



Fig. N

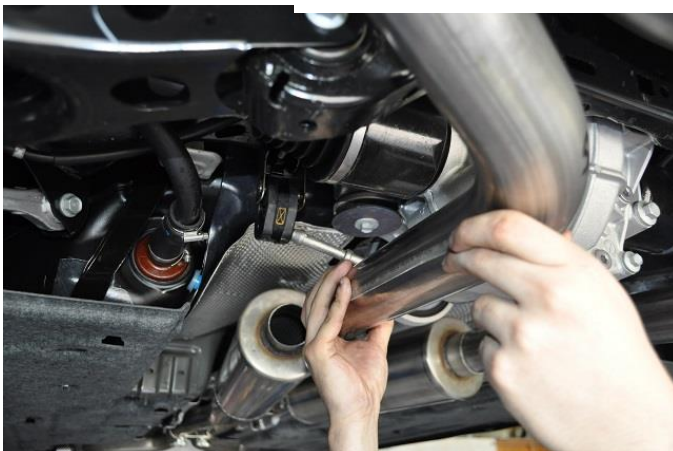

Fig. O



Fig. P

CORSA Installation Pictures



Fig. Q



Fig. R



Fig. S

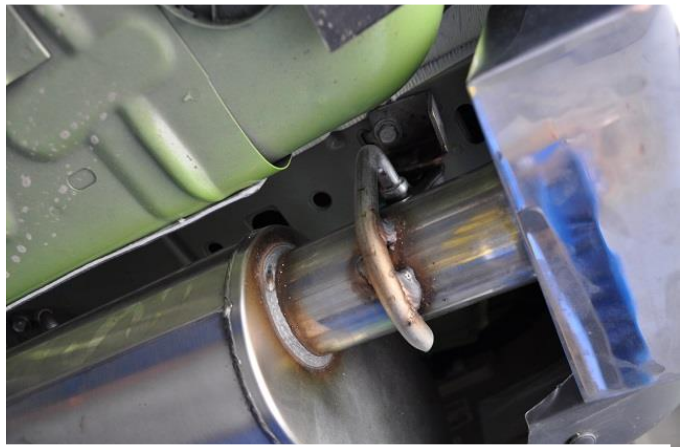

Fig. T



Fig. U

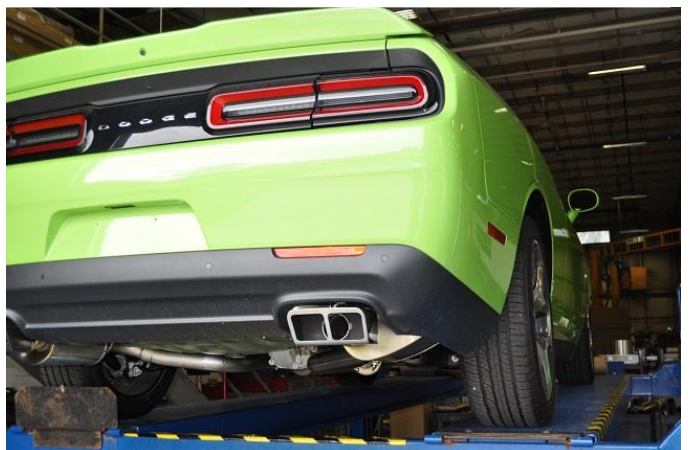

Fig. V