

INSTALLATION GUIDE: AWE MK7 VOLKSWAGEN GLI

THIS PRODUCT IS INTENDED FOR THE FOLLOWING VEHICLES*:

YEAR	MAKE	MODEL	SUBMODEL	ENGINE
2019	VW	Jetta	GLI	2.0T

THIS GUIDE IS INTENDED FOR THE FOLLOWING PART NUMBERS:

3020-22034	AWE Track Edition Exhaust - Non-Resonated - for MK7 Jetta GLI w/ Stock Downpipe - Chrome Silver Tips			
3020-23036	AWE Track Edition Exhaust - Non-Resonated - for MK7 Jetta GLI w/ Stock Downpipe - Diamond Black Tips			
3015-22068	AWE Track Edition Exhaust - Resonated - for MK7 Jetta GLI w/ High Flow Downpipe - Chrome Silver Tips			
3015-23060	AWE Track Edition Exhaust - Resonated - for MK7 Jetta GLI w/ High Flow Downpipe - Diamond Black Tips			
3015-22070	AWE Touring Edition Exhaust - Resonated - for MK7 Jetta GLI w/ High Flow Downpipe - Chrome Silver Tips			
3015-23062	AWE Touring Edition Exhaust - Resonated - for MK7 Jetta GLI w/ High Flow Downpipe - Diamond Black Tips			

Welcome to the AWE family, and congratulations on your purchase of the AWE Exhaust system for the MK7 Volkswagen GLI.

Exquisite build quality and craftsmanship, coupled with industry leading performance, distinguish this exhaust system from all others.

*For up to the minute fitment information, be sure to visit the AWE website. As always, AWE Performance Specialists are standing by for any questions, [right here](#).

PARTS LIST



INSPECT ALL PARTS PRIOR TO DISASSEMBLY OF VEHICLE; IF DAMAGED OR MISSING, PLEASE CONTACT THE PLACE OF PURCHASE IMMEDIATELY.

QTY	Description	Part Number
MK7 GLI Track Non-Resonated, Track Resonated and Touring		
1	MK7 Volkswagen Jetta GLI inlet adapter	C36
1	Non-res front section	LJ
1	GLI T-merge	C39
1	GLI DS axle tube	C40
1	GLI PS axle tube	C41
3	3.00in ACCU-SEAL	TAS300
4	2.50in (63.5mm) ACCU-SEAL	TAS250
2	Stainless steel barrel hardware clamp	BHM8X067SS00C
2	102mm tip	31122253A (chrome) - 31122254 (black)
2	Split collar clamp	SRC1-050
1	9/64" allen wrench	7122A19
Track Non-Resonated Only		
1	GLI mid muffler delete section	C38
1	GLI DS Track rear section	C44
1	GLI PS Track rear section	C45
Track Resonated Only		
1	GLI mid muffler section	C37
1	GLI DS Track rear section	C44
1	GLI PS Track rear section	C45
Touring Only		
1	GLI mid muffler section	C37
1	GLI DS Touring rear section	C42
1	GLI PS Touring rear section	C43

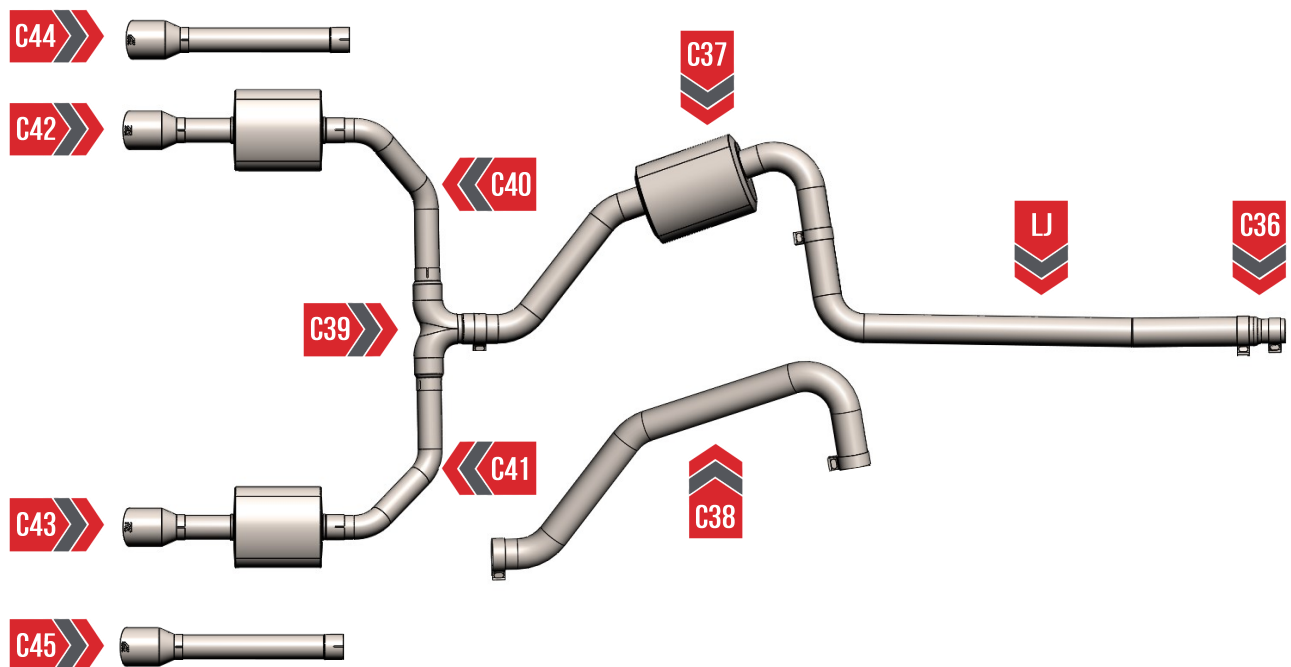



NOTE: Always refer to the manufacturer's service manual for precise torque specifications on all OEM fasteners.



CAUTION: The exhaust may be **VERY HOT** — allow adequate time for the system to cool down before disassembly. Severe burns and injury will occur if skin comes into contact with a hot exhaust system.

STEP 1

Start by removing the front and rear OEM chassis brace, shown in **Figures 1-1 & 1-2**. Place them out of the way. These chassis braces will be reinstalled after your AWE Exhaust is in place.

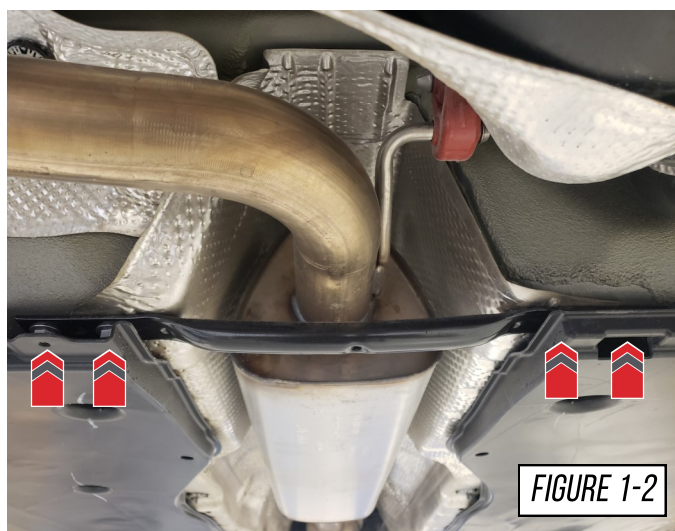
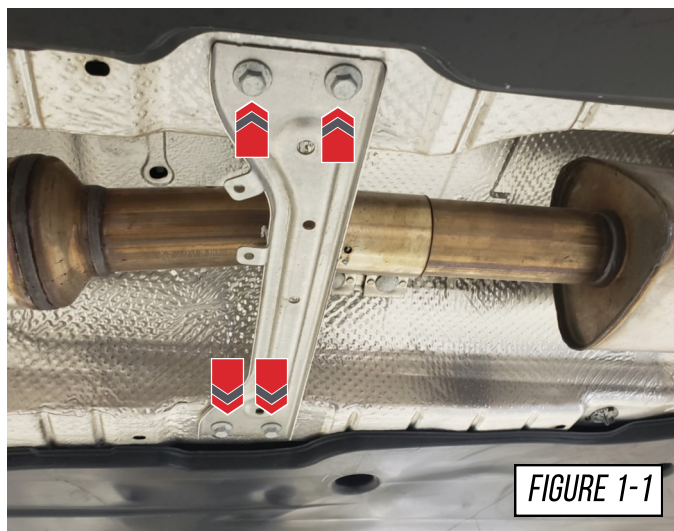

STEP 2

With the OEM chassis braces removed, loosen the sleeve clamp connecting the factory downpipe and the rear portion of the exhaust, shown in **Figure 2**.

Slide the sleeve clamp back onto the downpipe. This clamp will be reused in your AWE exhaust installation



NOTE: The OEM exhaust system should be safely supported before disassembly

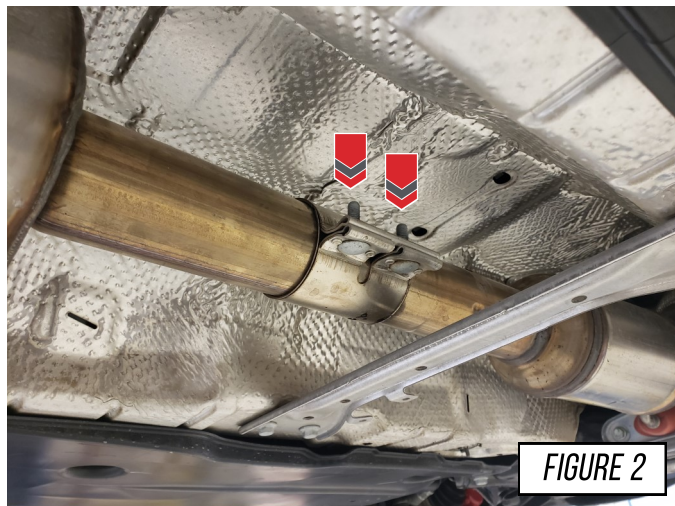

STEP 3

Continue the removal of the exhaust by removing the exhaust from the exhaust hangers, shown by **Arrow A** and **Arrow B** in **Figure 3-1**, **Figure 3-2** and **Figure 3-3**.

The rear hangers, shown by **Arrows C** in **Figure 3-1** and **Figure 3-4**, are able to be removed with the exhaust system by removing the bolt holding them in place. The orientation of the hangers since they will need to be reinstalled the same way when installing the AWE exhaust.

 **WARNING:** The OE exhaust is best handled by two people.

NOTE: Use a penetrant oil to spray onto the hangers where they are hung in the rubber bushing, this will help with removal.

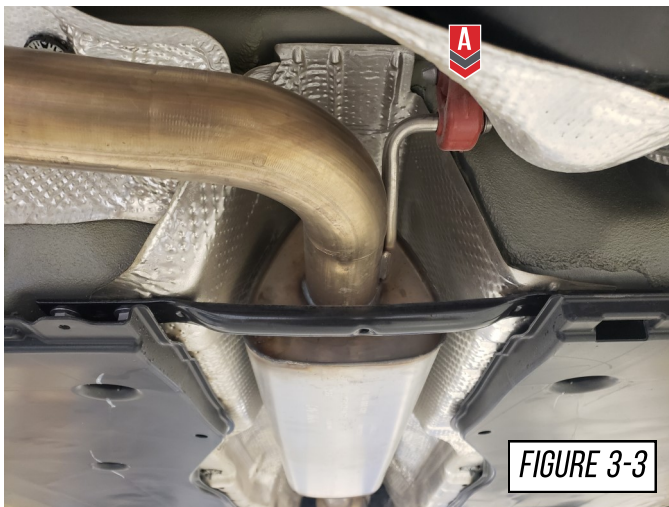
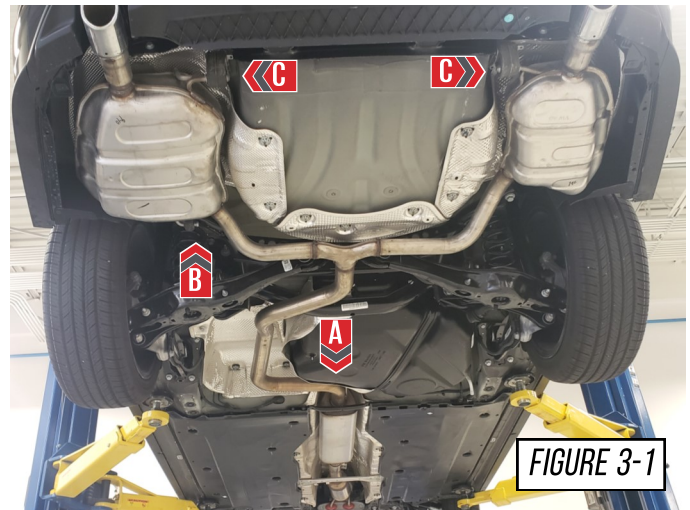

STEP 4

The Jetta GLI chassis has two hanger locations around the rear drivers side suspension. The factory system uses the hanger shown by **Arrow A** in **Figure 4**

The AWE exhaust utilizes the hanger shown by **Arrow B** in **Figure 4**

Remove the factory rubber hanger from position A and transfer onto the hanger in position B.



STEP 5

Installation of the AWE Tuning Exhaust:

Begin installing your AWE exhaust by gathering the OEM downpipe to AWE Exhaust adapter part **C63**. Install the adapter with the OEM sleeve clamp. Tighten the bolts on the clamp just tight enough to keep the adapter from falling out, as shown in **Figure 5**.

Do not torque any clamps until the final step, after the entire system has been installed and adjusted to satisfaction.



STEP 6

Next gather the front section part LJ. Slide a supplied 3" Accu-Seal clamp over the tube and connect the slip joint, **Arrow A** in **Figure 6-1**. Do not fully tighten the clamp at this point. Leave it loose enough to adjust the fitment in the final step.

Secure the hanger on the front section into its respective hanger mount. **Arrow B** in **Figure 6-1** and **Figure 6-2**.

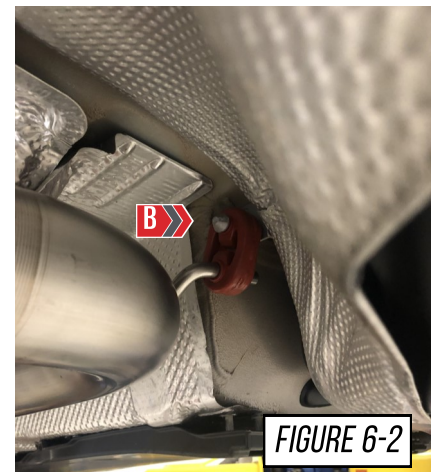
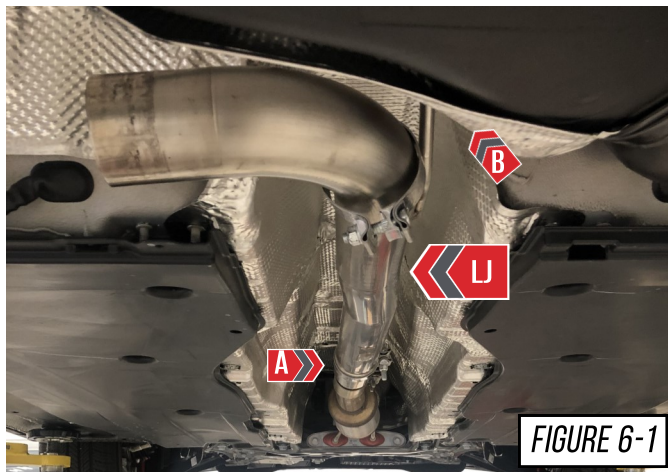

STEP 7

Next gather your rear AWE mid muffler section, part **C37** for touring and resonated track, or part **C38** for non-resonated track. Gather another supplied 3" Accu-Seal clamp and slide it over the inlet of the mid muffler, shown **Arrow B** in **Figure 7**. Secure the mid muffler hanger to the location shown by **Arrow A** in **Figure 7**. Once again snug the clamp but do not fully tighten.



NOTE: As stated in Step 4 of the instructions, you are required to relocate the factory hanger.

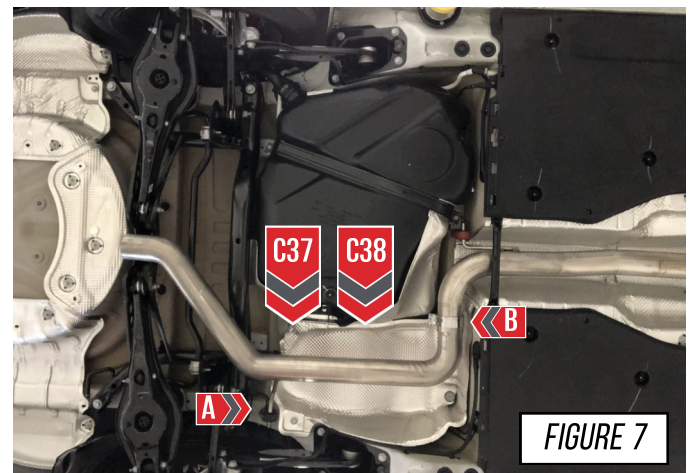

STEP 8

Install the rear AWE T-merge part **C39** using the last supplied 3" Accu-Seal clamp. Make sure the merge is level to aid in aligning the rear section of your new AWE exhaust, as shown in **Figure 8**.

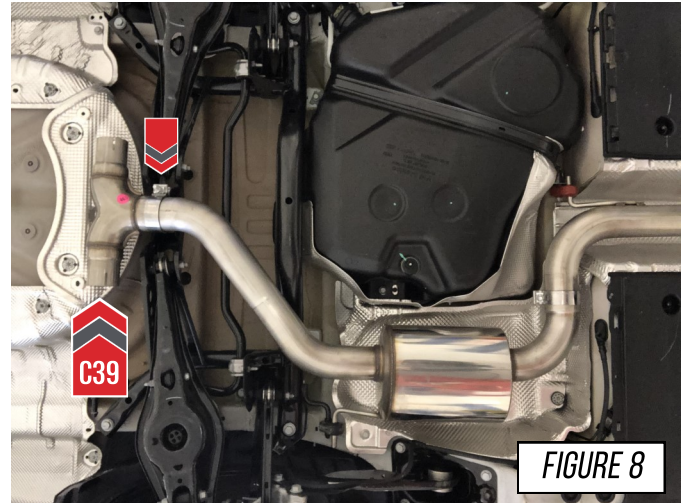

STEP 9

Continue by installing the two axle tubes. These parts are side specific, part **C40** being drivers side and **C41** being passenger side. Install using a supplied 2.5" Accu-Seal clamp on each side. Tighten clamps enough that the axle tubes will not rotate when unsupported, as shown **Figure 9**.

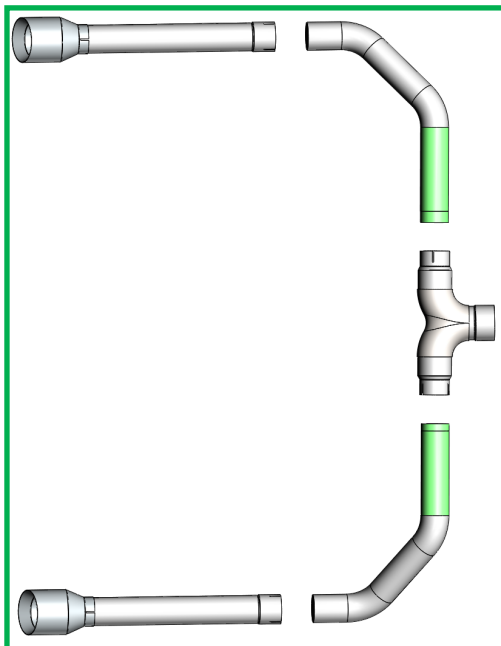
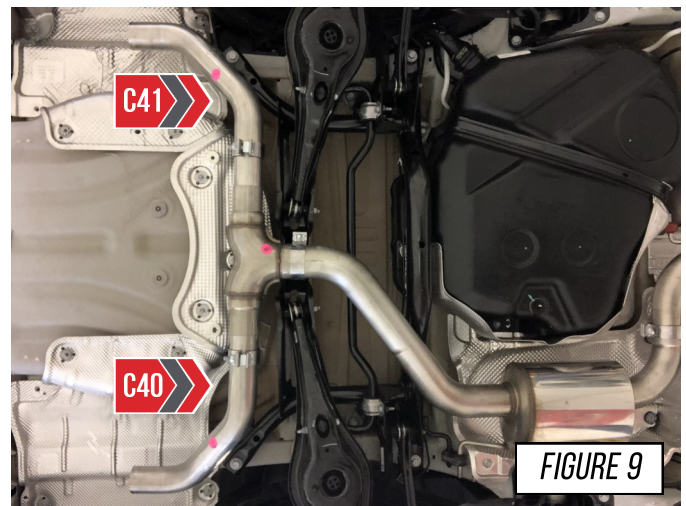

CORRECT

Long legs mated with branch

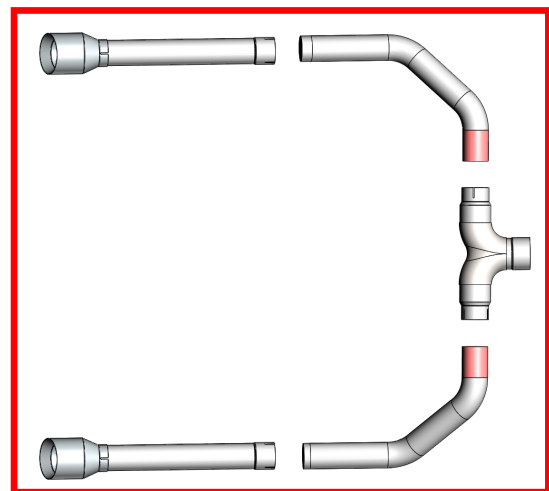

INCORRECT

Short legs mated with branch

STEP 10

Gather the AWE rear driver and passenger section, Touring parts **C42/ C43** or Track parts **C44/ C45**. Install the OEM exhaust hanger removed earlier in the same orientation as removed, shown in **Figure 10-1** and **Figure 10-2**.

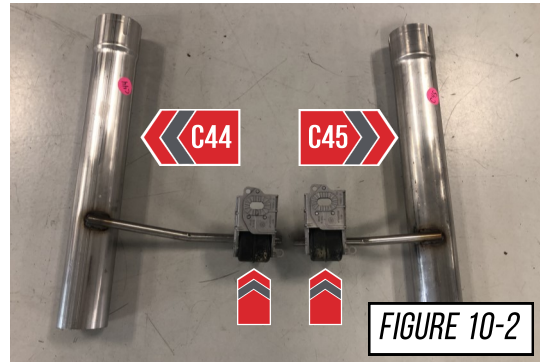
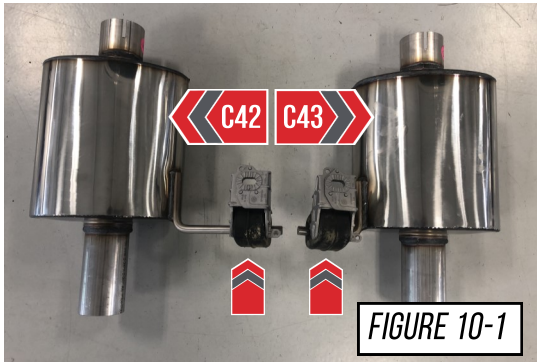

STEP 11

Install your rear AWE driver and passenger side exhaust sections, Track parts **C44/ C45** or Touring parts **C42/ C43**. Use 2 supplied Accu-Seal clamps to secure these 2 tubes, do not fully tighten the clamp at this point. Then install the OEM bolts into the OEM rear hangers you previously installed onto the hanger, as shown in **Figure 11-1** and **Figure 11-2**.

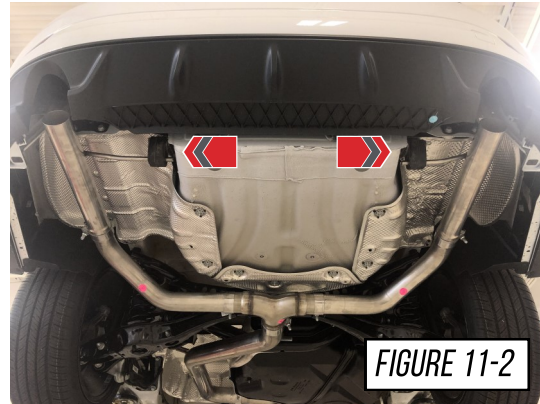

STEP 12

It is crucial to install each section and Accu-Seal clamp correctly to prevent loose joints, exhaust leaks between the tubing connections and rattles.

Arrow A in **Figure 12** shows the expanded pipe and the preinstalled Accu-Seal clamp being brought up to the corresponding pipe.

Arrow B in **Figure 12** shows the overlapping pipe installed correctly over the corresponding pipe.

Arrow C in **Figure 12** shows the Accu-Seal clamp being brought to the edge of the expanded pipe.

NOTES:



- **Do not** torque any Accu-Seal clamp until the entire exhaust has been installed and adjusted.
- Torque specification is a minimum of 60 ft/lbs

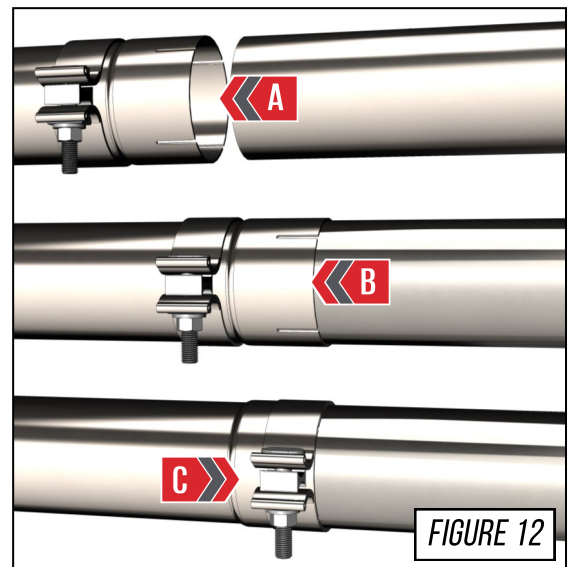

STEP 13

At this point your AWE exhaust system is installed. Go over the whole exhaust and check for proper clearances to the chassis, ensuring there is no contact. With all slip joints full bottom, tighten all the Accu-Seal clamps, the OEM sleeve clamp and the OEM rear hangers.

 Refer to Step 12 on proper installation of Accu-Seal clamps.

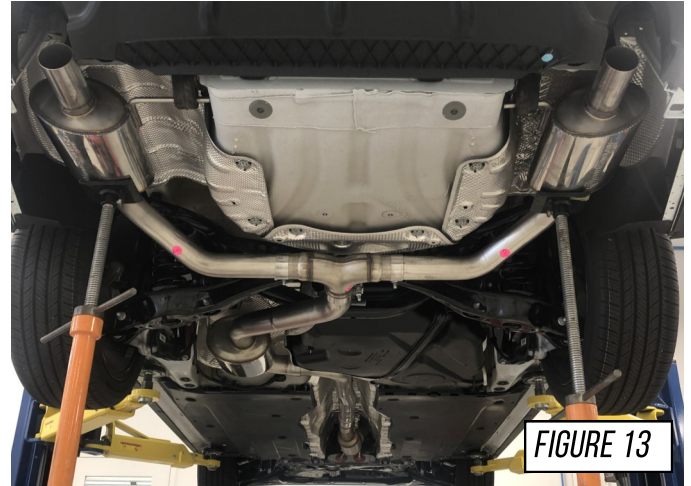

STEP 14

Install your new AWE exhaust tips with the supplied t-bolt clamps, as shown in **Figure 14-1** and **Figure 14-2**.

 Use anti-seize on the threads of the t-bolt clamps.



STEP 15

Reinstall both OEM chassis braces, with the OEM hardware removed previously, as shown in **Figure 15**.

 Torque all bolts to factory specs.

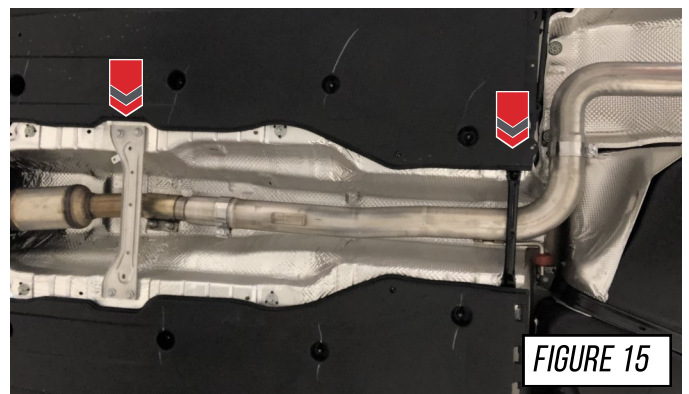

ENJOY!



TROUBLESHOOTING

Issue	Solution
Exhaust is not fitting correctly	Most fitment issues are due to improperly adjusted exhaust. This includes tip fitments and rattling due to chassis contact. Check out our fitment guide for more installation tips.
Wrong or missing parts	Double check the parts list for your system and compare them with what you received. Fill out our contact form, found below and let us know what parts you need.

CARE

Once installed properly, your AWE exhaust will provide years of trouble-free performance.

The exhaust volume and sound will settle with usage; 800-1000 miles is required to break-in new exhaust systems.

Also, please note that the rear **180Technology®** resonator has a small drain hole to allow condensation to escape. Water drops from this area are normal.

Periodic cleaning of exhaust tips is necessary to maintain proper finish, especially in areas prone to road salt and caustic deicing solutions. Use a mild soap and water solution or car wax to clean the finish. Avoid using abrasive polishes, as they can scratch the finish.

Any questions or comments,
please do not hesitate to contact us:

AWE
199 Precision Drive
Horsham, PA 19044
215-658-1670
[CONTACT FORM](#)

WARRANTY

Up-to-date warranty information is found [HERE](#).