



IMPORTANT WARRANTY & INSTALLATION INSTRUCTIONS ATTACHED

*Please Forward All Attached Information to Consumer
Warranty Not Valid Unless Returned to CORSA Exhaust*

We ask that you take a few moments to complete our warranty registration form:

TO ACTIVATE YOUR LIMITED LIFETIME WARRANTY GO TO:

CORSAPERFORMANCE.COM/WARRANTY



For Full-Color Installation Instructions, Please Visit:

CORSAPERFORMANCE.COM and Search by Part Number

Please be sure to review the enclosed instructions prior to beginning the installation process. If you have any questions about the enclosed parts, instructions or encounter a problem during Installation: **CALL CORSA PERFORMANCE TECHNICAL ASSISTANCE AT 800.486.0999**

Please take time to read and understand these installation instructions.

CORSA recommends that installation of this system be performed by a qualified service center or professional muffler installer who has the necessary equipment, tools and experienced personnel. However, if you decide to perform this install, the use of a hoist and an additional person will be required.

CAUTION: Never work on a hot exhaust system. Allow time for the vehicle to cool. Always wear eye protection when working under a vehicle.

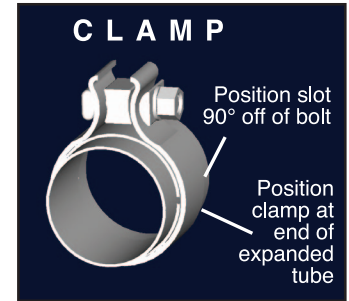

Please confirm that all parts are present before beginning the factory exhaust system removal and CORSA exhaust system installation.

Bill of Materials:

- Muffler Assembly (13BE2011)
- Driver Side Pipe (13BE4029)
- Passenger Side Pipe (13BE4031)
- Packet of Anti-Seize Lubricant
- Hardware Kit (13BE7007)
 - (2) 2.25" Clamps (15CT7013)
 - (2) 2.00" Clamps (15CT7012)
 - (1) Vacuum Cap (16CS7012)

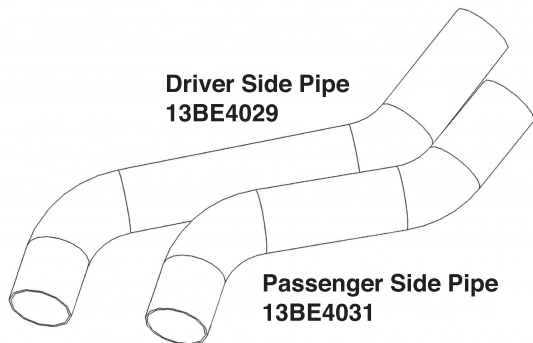

Recommended Tools:

- Safety glasses
- 15mm socket
- Torque wrench
- 13mm socket
- Ratchet wrench
- Long extension
- Reciprocating saw (with metal blade)
- String, wire, or flexible measuring tape

Muffler Assembly
13BE2011

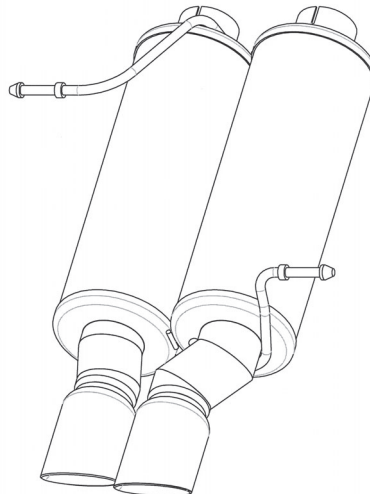

Anti-Seize Lubricant

Hardware Kit
13BE7007

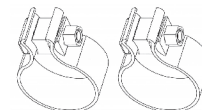

(2) 2.25" Clamps
15CT7013

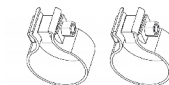

(2) 2.00" Clamps
15CT7012

(1) Vacuum Cap
16CS7012

Removal of Stock System:

1. Using string, wire, or flexible measuring tape measure 8.75" from the weld seam at the inlet of the stock muffler going towards the front of the vehicle, following the contours of the passenger side muffler inlet pipe (**See Fig A**). Mark the passenger side pipe for cutting and use reciprocating saw to make the cut (**See Fig B**).
2. Mark the driver side pipe directly across from passenger side cut and use reciprocating saw from the other side to cut through (**See Fig C**).
3. Both pipes should now be completely separated and cut in a straight line (**See Fig D**).
4. On 330 models, locate the vacuum line connected to the valve actuator on the rear muffler (**See Fig E**) and remove it from the actuator. Install the vacuum cap, supplied in the hardware kit, onto the remaining line and tuck the line behind the bumper out of the way (**See Fig F**).
5. With the long extension and 13mm socket installed on the ratchet, remove the nuts located on the hanger brackets of the rear muffler.

NOTE: All fasteners will be reused, do not discard.

Start with the bracket closest to the drivers side rear tire (**See Fig G**), and remove the two 13mm nuts. Next, remove the two nuts on the opposite hanger bracket (**See Fig H**).

CAUTION: Removing the second hanger bracket will completely free the rear muffler assembly, so prepare to support the assembly before removing nuts.



FIG. A

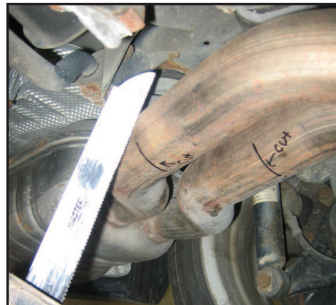

FIG. B



FIG. C



FIG. D

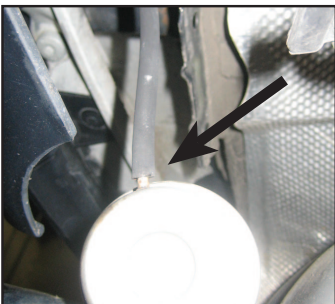

FIG. E



FIG. F



FIG. G



FIG. H

6. The stock rear muffler can now be removed from the vehicle and the hangers should be removed from the rubber grommets (**See Fig I**). These grommets will be reused on the new system.



FIG. I

Installation of CORSA Exhaust System:

NOTE: Apply the anti-seize lubricant (supplied) to the threads **ONLY** of all the clamps and flange bolts. Failure to follow this procedure can cause nuts to seize on clamps and potentially destroy threads. After applying anti-seize lubricant, be sure to thoroughly clean hands as lubricant will tarnish stainless steel. All clamps should be tightened using a properly calibrated Torque Wrench. Using an air impact gun will damage the clamp and reduce its ability to effectively seal the joint. It may also cause the joint to separate thereby causing damage to your exhaust system and your vehicle.

1. Remove rear muffler assembly (13BE2011), the passenger side pipe (13BE4031), the driver side pipe (13BE4029), and the hardware kit from the shipping carton.
2. Install the rubber grommets that were removed from the stock system onto the new muffler assembly. Using a solution of soapy water may aid in sliding the grommets onto the hangers.
3. Layout the muffler assembly, pipes, and clamps and assembly loosely (**See Fig J**). Notice the orientation of the clamps and the spacing between the driver and passenger pipes. These pipes are free to move for alignment purposes, but should always maintain a 1/2" gap to prevent rattles. Also, notice the pipes are reduced to 2" on the side away from the muffler. The smaller clamps go on the reduced end.
4. Mark the passenger side pipe, of the stock system still on the vehicle, 1-1/2" from the cut (**see Fig K**). This will be a depth gauge when installing the new muffler assembly.



NOTE: IMPORTANT-Make sure that the small drain or weep hole in muffler faces down when muffler is installed.



FIG. J



FIG. K

5. With the clamps still loose, slide the assembly over the stock pipes (**See Fig L**), and the driver side pipe should be further forward as shown.
6. After aligning the grommet brackets with the studs on the bottom of the car, tighten the nuts with the 13mm socket (**See Fig M & N**).
7. Before tightening any clamps:
 - a. Verify that the passenger side pipe is installed to the 1-1/2" mark on the stock pipes (**See Fig O**).
 - b. Verify that a minimum 1/2" gap is maintain between the driver and passenger pipes.
 - c. Align tips in bumper opening so that there is at least a 1/2" gap between the tip and the bumper to prevent heat damage (**see Fig P**).
8. After Step 7, the clamps are ready to be tightened. Starting with the clamps on the stock pipes, tighten both sides with a 15mm socket (**See Fig Q**). Recheck that the tip alignment is still correct and tighten the clamps on the inlet of the muffler (**See Fig R**). After the tip is the correct location, tighten all four clamps to **45 ft/lb** with the torque wrench. It is **strongly recommended** that all clamps be checked and tightened if necessary after road testing the vehicle and after system has cooled.



FIG. L



FIG. M



FIG. N

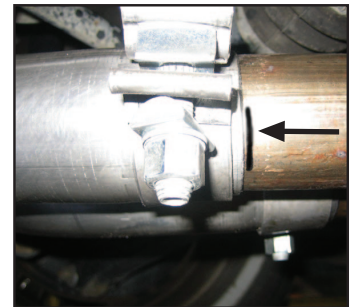

FIG. O



FIG. P



FIG. Q



FIG. R

NOTE: During cold weather start-ups, you may experience an exhaust sound that is deeper and louder in tone than usual. This is temporary and will diminish to normal levels once your engine has reached its normal operating temperature.

NOTE: Immediately following the installation of your CORSA exhaust system, you may experience a trace of smoke after initial start-up. DO NOT be alarmed. The smoke is caused by the burning of a small amount of forming oil residue used in the manufacturing process.

If you have any questions about the installation process, call CORSA Performance and ask one of our Sales & Technical Service Representatives. **Do not attempt to make any modifications to parts as this will void your warranty.**