



IMPORTANT WARRANTY & INSTALLATION INSTRUCTIONS ATTACHED

*Please Forward All Attached Information to Consumer
Warranty Not Valid Unless Returned to CORSA Exhaust*

We ask that you take a few moments to complete our warranty registration form:

TO ACTIVATE YOUR LIMITED LIFETIME WARRANTY GO TO:

CORSAPERFORMANCE.COM/WARRANTY



For Full-Color Installation Instructions, Please Visit:

CORSAPERFORMANCE.COM and Search by Part Number

Please be sure to review the enclosed instructions prior to beginning the installation process. If you have any questions about the enclosed parts, instructions or encounter a problem during Installation: **CALL CORSA PERFORMANCE TECHNICAL ASSISTANCE AT 800.486.0999**

Please take time to read and understand these installation instructions.

CORSA recommends that the installation of this system be performed by a qualified service center or professional muffler installer who has the necessary equipment, tools and experienced personnel. However, if you decide to perform this install, the use of a hoist and an additional person will be required.

CAUTION: Never work on a hot exhaust system. Allow time for the vehicle to cool. Always wear eye protection when working under a vehicle.

Please confirm that all parts are present before beginning the factory exhaust system removal and CORSA Performance Exhaust system installation.

Recommended Tools:

- Safety Glasses
- 13mm Socket
- 10mm Socket
- 15mm Socket
- 3/8" Ratchet
- Grommet Pullers
- 12" Ratchet Extension
- Torque Wrench
- Soap & Water Solution

Bill of Materials:

- 1 16TA3000 (Tip Assembly)
- 2 20FF2018 (Muffler Assembly)
- 3 20FF4097 (Tailpipe Assembly)
- 4 20FF4105 (Intermediate Pipe Assembly)
- 5 20FF7026 (Hardware Kit)

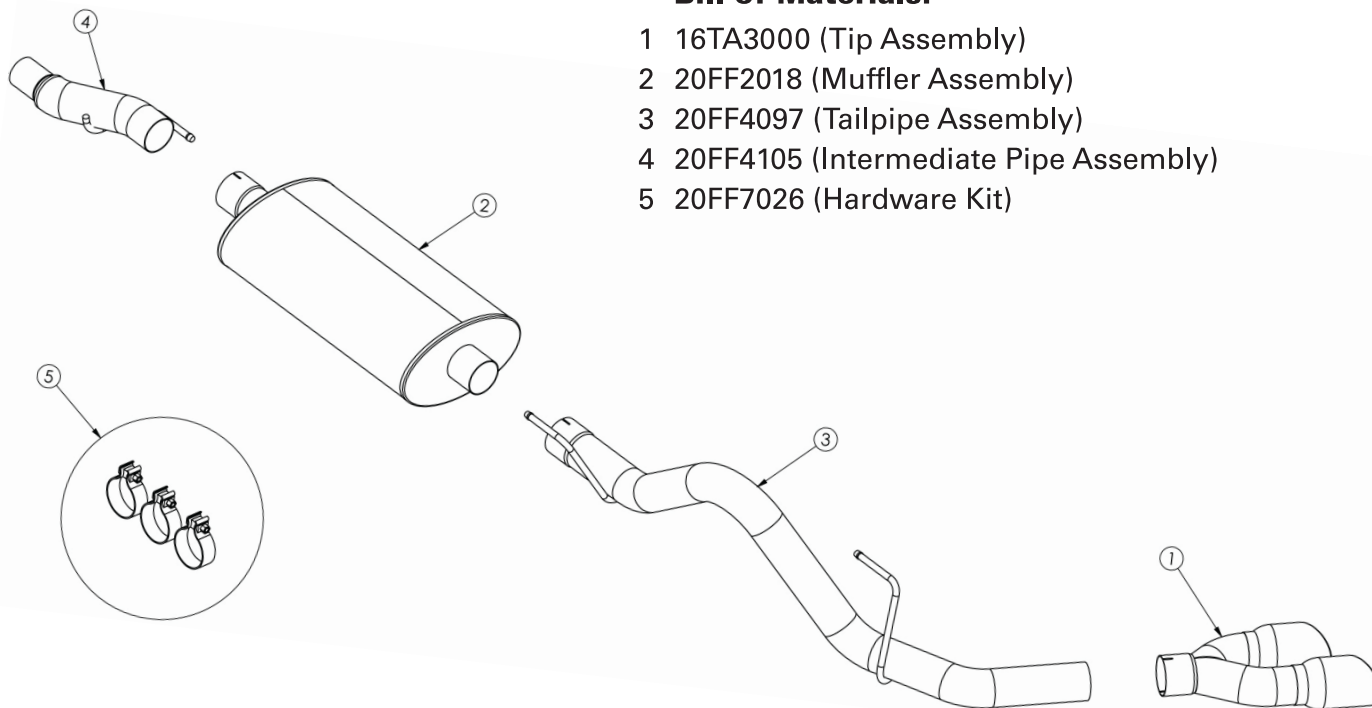

Removal of Stock Exhaust System:

1. Remove both bolts that secure the flange connection on the factory center pipe using a 13mm socket and ratchet. **(See Fig. A)**
2. Unbolt the muffler hanger mount from the chassis using a 10mm socket and ratchet. **(See Fig. B)**
3. Unbolt the front tailpipe hanger mount from the chassis using a long extension, and a 10mm socket and ratchet. **(See Fig. C)**
4. Unbolt the rear tailpipe hanger mount from the chassis using a long extension, and a 10mm socket and ratchet. **(See Fig. D & E)** Carefully remove the entire stock exhaust system from the vehicle by moving it forward and down past the rear axle. **(See Fig. F)** The stock exhaust is removed as one piece and is fully intact.
5. With the stock exhaust on the ground, loosen the clamp on the factory center pipe using a 15mm socket and ratchet. **(See Fig G)** Rotate the center pipe until the retaining boss on the stock exhaust is aligned with the slot and then remove the center pipe from the rest of the factory system. **(See Fig. H & I)**



FIG. A



FIG. B

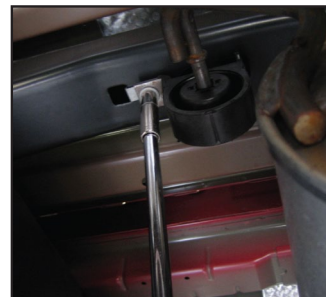

FIG. C



FIG. D

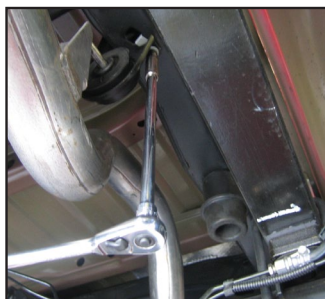

FIG. E

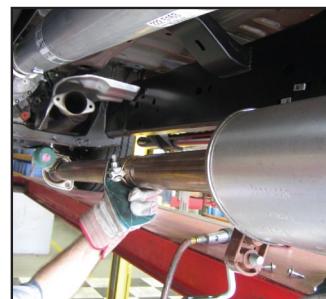

FIG. F



FIG. G



FIG. H



FIG. I

6. Remove the factory muffler and tailpipe hangers from the rubber isolators on the hanger mounts using a grommet puller or a similar device. (See Fig. J, K, & L) Note the position and orientation of each hanger mount. Set aside the muffler and tailpipe hanger mounts and the retaining bolts to be reused during the installation process.

NOTE: The use of a soapy water solution may aid in the removal and later installation of the hangers in the rubber isolators.

7. Removal is now complete. Installation of your CORSA Performance exhaust system can now begin.

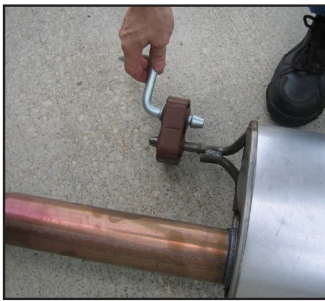

FIG. J



FIG. K



FIG. L

Installation of CORSA Performance Exhaust System:

NOTE: Apply the anti-seize lubricant (supplied) to the threads ONLY of all the clamps and flange bolts. Failure to follow this procedure can cause nuts to seize on clamps and potentially destroy threads. After applying anti-seize lubricant, be sure to thoroughly clean hands as lubricant will tarnish stainless steel.

NOTE: Align all clamps so that the center of the clamp bolt is 90 degrees from the notch in the pipe (See Fig. M)

All clamps should be tightened using a properly calibrated Torque Wrench. Using an air impact gun will damage the clamp and reduce its ability to effectively seal the joint. It may also cause the joint to separate thereby causing damage to your exhaust system and your vehicle.

1. Remove all exhaust system components from the shipping carton, including the three supplied 3" clamps.
2. Locate the factory center pipe that was disconnected during the removal process, along with the two 13mm mounting bolts. Align the flanges, and snug tighten both of the bolts using a 13mm socket and ratchet. Make sure that the center pipe is oriented so that the notch at the rear of the pipe faces upwards. (See Fig. N)

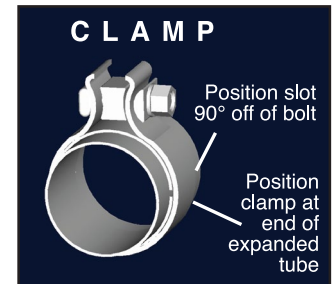

FIG. M



FIG. N

3. Locate the intermediate pipe assembly, and the muffler hanger mount, along with the two 10mm mounting bolts. Align the hanger mount with the mounting holes in the chassis, and secure with a 10mm socket and ratchet. Note the proper orientation of the muffler hanger mount as shown in the figure. Torque the 10mm bolts to factory specs. **(See Fig. O)**

NOTE: Using a soapy water solution on the muffler hanger grommet at this time will make the following step much easier to accomplish.

4. Insert the intermediate pipe hanger into the factory muffler hanger grommet, and then move the front end of the intermediate pipe forward into the factory center pipe. Seat the front end of the intermediate pipe assembly into the center pipe expansion, past the end of the factory clamp. Use a rubber mallet if necessary to make sure the pipe is properly seated. The end of the hanger will be flush with the end of the hanger mount rod when the depth of the pipe is correct. **(See Fig. P)**
5. Rotate the intermediate pipe assembly until the grommet is straight up and down, and the hanger is directly underneath the hanger mount rod. Snugly tighten the factory clamp on the center pipe using a 15mm socket and ratchet. **(See Fig. Q)**
6. Locate the CORSA Performance muffler, and a 3" clamp. Properly align the clamp on the muffler inlet, and then slide it over the end of the intermediate pipe assembly.

IMPORTANT: Make sure that the small drain hole in the rear of the muffler is facing straight downwards when the muffler is installed. (See Fig. R)

7. Secure the muffler in place by snugly tightening the clamp as shown, using a 15mm socket and ratchet. Note the position and orientation of the clamp. **(See Fig. S)**



FIG. O



FIG. P



FIG. Q



FIG. R



FIG. S

NOTE: The unbolted tailpipe hanger assemblies from the removal process should now be installed onto the corresponding hangers on the tailpipe by pushing the rubber grommets onto the hangers. Once again, a soapy water solution will aid in this installation process. (See Fig. T & U)

8. Locate the rear tailpipe assembly, along with the 10mm hardware to secure the hanger mounts, and another 3" clamp. Properly align the clamp on the tailpipe inlet, and then slide the expanded end of the tailpipe onto the outlet of the rear muffler. Align the hanger mounts with the mounting holes in the chassis, and secure with a 10mm socket and ratchet, and a long extension. Note the proper orientation of the tailpipe hanger mounts as shown. Torque the 10mm bolts to factory specs. (See Fig. V, W, & X)
9. Rotate the rear tailpipe assembly until the rearmost section of the pipe is horizontal, and then secure it in place by snugly tightening the clamp as shown, using a 15mm socket and ratchet. (See Fig. Y)
10. Locate the CORSA Performance side swept tip assembly, and the last 3" clamp. Properly align the clamp on the tip inlet, and then slide the tip assembly onto the end of the tailpipe. (See Fig. Z) Rotate the tip until the CORSA Performance logos are centered on the top side of both tips. (See Fig. AA) Snugly tighten the clamp as shown using a 15mm socket and ratchet, making sure to only tighten the clamp enough to hold the tip in place on the tailpipe. (See Fig. BB)



FIG. T



FIG. U



FIG. V

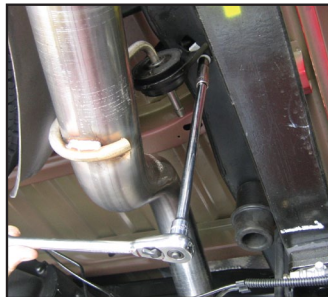

FIG. W



FIG. X



FIG. Y



FIG. Z



FIG. AA



FIG. BB



CORSA Performance Exhaust System Installation
Cat-Back Exhaust System
Ford F-150
2009-10 4.6L/5.4L V8 & 2010+ Raptor 5.4L V8 (only)
Single Side Exit w/ Twin Side Swept 4.0" Pro-Series Tips
PART NUMBER 14388

11. Visually inspect the exhaust system position, tip alignment, clamp orientation and position, and exhaust pipe clearance. Make any necessary adjustments at the slip joints.
12. Fully tighten the 13mm bolts on the center pipe flange. Torque to the factory specs. Next, tighten the clamp on the factory center pipe to 45 ft-lbs.
13. Starting at the front of the vehicle, tighten the nuts on the three supplied clamps. Torque the nuts to 45 ft-lbs.
14. It is **STRONGLY SUGGESTED** that all clamps be checked and re-tightened (if necessary) to the recommended torque after initial road testing of the vehicle, as thermal cycling has occurred on the system. Please wait until system has fully cooled to perform this step.

NOTE: During cold weather start-ups, you may experience an exhaust sound that is deeper and louder in tone than usual. This is temporary and will diminish to normal levels once your engine has reached its normal operating temperature.

NOTE: Immediately following the installation of your exhaust system, you may experience a trace of smoke after initial start-up. DO NOT be alarmed. The smoke is caused by the burning of a small amount of forming oil residue used in the manufacturing process.