



Installation instructions

Akrapovič Exhaust Systems:

Tail Pipes, Evolution and Optional Down Pipe
for the

MINI COOPER S (type R56)

MINI COOPER S Cabrio (type R57)

MINI COOPER S Coupe (type R58)

MINI JCW (type R56)

MINI JCW Cabrio (type R57)

MINI JCW Coupe (type R58)

WARNING

Please note that certain aftermarket exhaust systems may not comply with applicable California laws and regulations, and may therefore be prohibited for use on California highways or roads, or on roads or vehicles otherwise subject to emissions control requirements.

Akrapovič exhaust systems for automobiles and motorcycles mounted downstream of the catalytic converter (also known as “cat-back systems”) are considered “replacement parts” in California by the California Air Resources Board (CARB), and do not require an exemption or executive order from CARB to be sold in California. However, California prohibits the use of any aftermarket exhaust system that modifies, removes or replaces original equipment catalysts, unless CARB has issued an Executive Order as to such part or system.

Further, Akrapovič parts or exhaust systems used or intended for use on “racing vehicles” (i.e. a competition vehicle used exclusively for competition on closed-course circuits) do not require an exemption or Executive Order from CARB to be sold in California. However, such parts are prohibited from use on California public highways or roads, even if occasionally used “off-road.”



Installation instructions

Akrapovič Exhaust Systems:

Tail Pipes, Evolution and Optional Down Pipe

for the

MINI COOPER S (type R56)

MINI COOPER S Cabrio (type R57)

MINI COOPER S Coupe (type R58)

MINI JCW (type R56)

MINI JCW Cabrio (type R57)

MINI JCW Coupe (type R58)

Congratulations on purchasing an Akrapovič exhaust system. Please read the entire installation manual prior to undertaking any activities related to installation of your new Akrapovič exhaust system. In case you do not fully understand the manual or any of its parts, please contact your authorized dealer!

This product should be installed by someone with sufficient knowledge of exhaust systems and their installation, and appropriate hand or power tools. If you are not qualified for this work, please utilize a certified mechanic for installation. By installing Your Akrapovič exhaust system, you indicate that you have read the installation manual in its entirety and you agree with the terms stated herein.

It is your responsibility to follow all installation instruction guidelines supplied with the Akrapovič exhaust system and undertake all necessary safety precautions. Akrapovič d.d. assumes no responsibility for damages occurring from misuse, abuse, improper installation, improper operation, lack of responsible care, or all previously stated reasons resulting from incompatibility with other manufacturer's products and/or systems.

IMPORTANT INFORMATION

Exclusion of Certain Liability

1. The manufacturer, importer or dealer shall not be liable for any incidental damage including personal injury or any other damages caused by improper installation or operation of the Akrapovič exhaust system. When installing the Akrapovič exhaust system be careful that the exhaust system does not touch other parts sensitive to high temperature.
2. Akrapovič makes no representation or warranties with regard to damage caused by the improper installation, use and maintenance of the Akrapovič exhaust system. The warranty is limited to defects recognized by our technical department and due to normal use, and excludes items subject to normal wear (gaskets and damping wool). The guarantee is void in case of accident, modification, improper or competition use.
3. Do not attempt to install the Akrapovič exhaust system on a vehicle model for which it was not made or tested by Akrapovič.
4. When the exhaust system gets very hot during operation, be careful not to burn yourself on the exhaust system or parts which are in direct contact with it, even when the engine is not running. Also protect other people, especially children, from the injuries mentioned above.

1. In some cases Akrapovič exhaust system kits contain chemical products (ceramic anti-seizing grease; bolt sealant). Handle with care, do not inhale or swallow. Avoid excessive contact with skin, eyes or mucous membranes. Keep out of reach of children.
2. Technical specifications of Akrapovič exhaust systems and related products are subject to change without notice.
3. Before removing the original exhaust system from your vehicle, please compare the parts you received with the list of materials provided in the installation manual in order to assure that you have all the parts necessary for the installation of your new Akrapovič exhaust system.
4. Although this manual consists of instructions for installation in written form, as well as photographs and pictures representing individual steps of the installation, please note that the photographs and pictures are symbolic and are intended for representation of general overview only. The photographs and pictures contained herein should serve as a guideline only and actual installation of the exhaust system may not correspond with the photographs and pictures entirely.
5. The process of uninstalling the original exhaust system may vary depending on the existing exhaust system. Please follow the original exhaust system manufacturer's instructions for uninstalling the original exhaust system.

Trademarks

The Akrapovič Exhaust System Technology logo is a registered trademark of Akrapovič d.d.

Akrapovič website

Information about Akrapovič exhaust systems and related products is available on the Akrapovič website at:

<http://www.akrapovic.com/>

Copyright

No part of the Akrapovič exhaust system or its documentation may be reproduced or distributed in any form or by any means without the prior written authorization of the Akrapovič company.

© Akrapovič, d.d. All rights reserved.

Symbols

The following symbols are used throughout these installation instructions:



TOOLS REQUIRED



TIGHTENING TORQUE



INSTALLATION TIP



CAUTION OR WARNING



USE BOLT SEALANT; Apply 3 to 4 small drops of bolt sealant onto the cleaned and degreased threads before tightening the bolts. **WARNING! Avoid contact with skin, eyes and mucous membranes. Do not inhale fumes. Keep out of the reach of children.**



USE ANTI-SEIZE LEAD-FREE COPPER PASTE (black tube); Provides trouble-free and long-lasting protection against seizing, corrosion and rusting of bolts, threaded ends, nuts, joints, etc. Also protects against vibration, wear and impact. **WARNING! Avoid eye contact. Avoid excessive skin contact. Keep out of reach of children.**



USE ANTI-SEIZING GREASE (white tube); Prevents seizing, corrosion and excessive wear between the titanium components of your exhaust system. **WARNING! Avoid eye contact. Avoid excessive skin contact. Keep out of reach of children.**



T-handle 10mm wrench
T-handle 13mm wrench
T-handle 3 mm three hexagon key wrench
Combination 13mm wrench
Combination 16mm wrench
Combination 22mm wrench
Two large screwdrivers



BEFORE INSTALLING, CHECK SCHEMATIC OF THE EXHAUST SYSTEM! THE LATEST VERSION OF THE PARTS LIST AND SCHEMATIC DRAWINGS OF THE PRODUCTS ARE AVAILABLE ON OUR WEB PAGE.



IF ANY ITEMS IN THE AKRAPOVIČ EXHAUST SYSTEM PACKAGE ARE MISSING, PLEASE CONTACT YOUR AUTHORIZED DEALER. KEEP THE SCHEMATIC FOR FUTURE REFERENCE.



THESE INSTALLATION INSTRUCTIONS MUST BE READ CAREFULLY IN ORDER TO ENSURE PROPER INSTALLATION AND OPERATION OF THE AKRAPOVIČ EXHAUST SYSTEM.



THE EXHAUST SYSTEM CAN BE EXTREMELY HOT. ALLOW THE EXHAUST AND ENGINE TO COOL DOWN BEFORE BEGINNING INSTALLATION.



WE ADVISE YOU TO LEAVE INSTALLATION TO A QUALIFIED SERVICEMAN. IMPROPER INSTALLATION MAY RESULT IN A SHORTER LIFETIME OF THE EXHAUST SYSTEM AND/OR DAMAGE TO THE VEHICLE.



THIS MANUAL IS SPECIFIC TO THE MINI COOPER S. THERE MAY BE SOME DIFFERENCES IN INSTALLATION PROCEDURES FOR OTHER MODELS.

REMOVAL OF ORIGINAL EXHAUST SYSTEM:

Put the vehicle onto a car lift.

! **WARNING:** make sure, that car lifting is safely and correctly done or you risk vehicle damage, injury or even death!

1. **For Tail Pipes only:** unscrew the marked bolts and remove the original tail pipes off the vehicle (Figure 1).

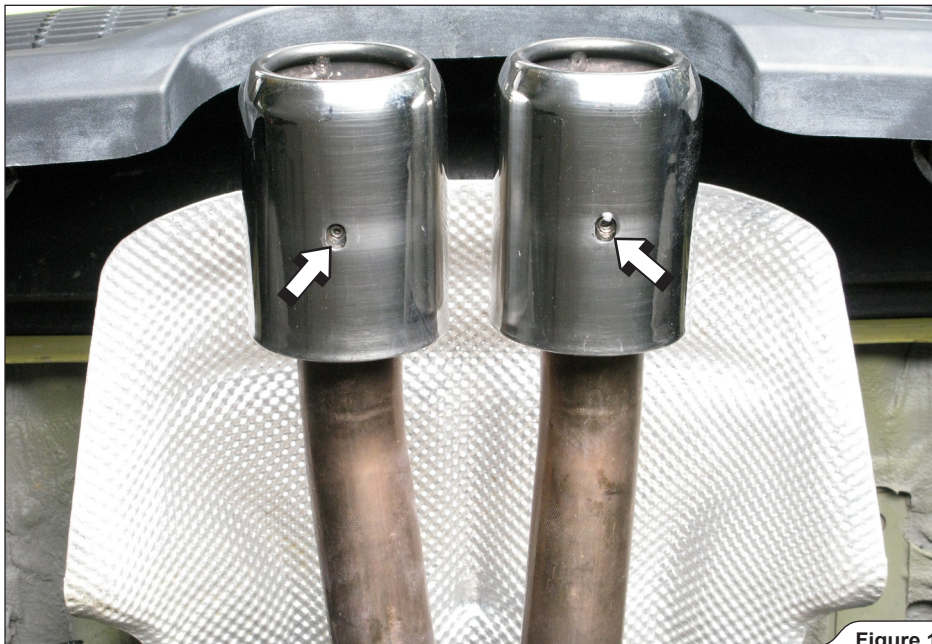

Figure 1

2. **For Tail Pipes only:** mark the muffler outlet pipes **35mm** from the edge of the pipe, as shown in figure. Cut pipes with angle grinder or equivalent (**Figure 2**).
- !** **WARNING:** make sure, that you don't injure yourself or damage any part of the vehicle during cutting process! Use personal protection equipment!

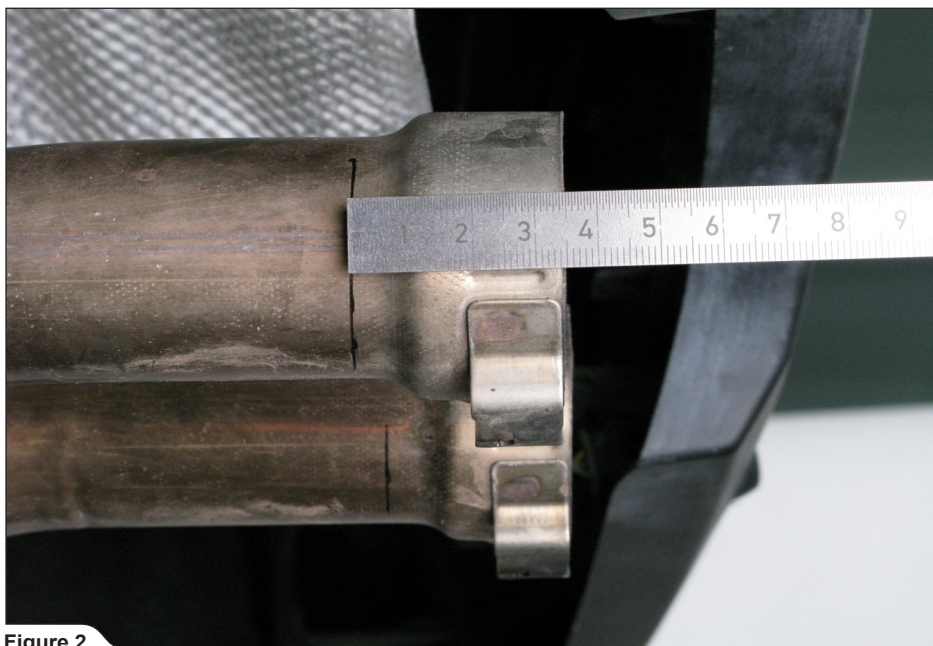

Figure 2

3. **For Evolution and Optional Down Pipe:** unscrew the marked bolts and remove the reinforcement plate off the vehicle (**Figure 3**).

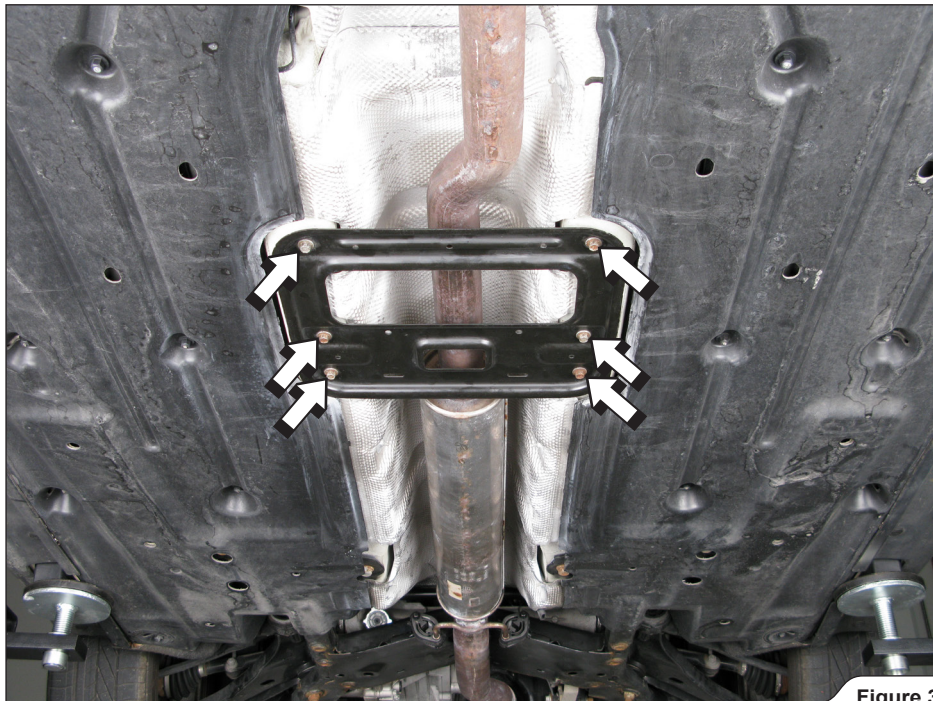

Figure 3

4. **For Evolution and Optional Down-Pipe:** unscrew the nut of the original clamp, remove the bolt, widen the clamp (using two large screwdrivers) and remove it out of the way, as shown (Figure 4, 5).
- ! **WARNING:** make sure, that original exhaust system is supported during removal!

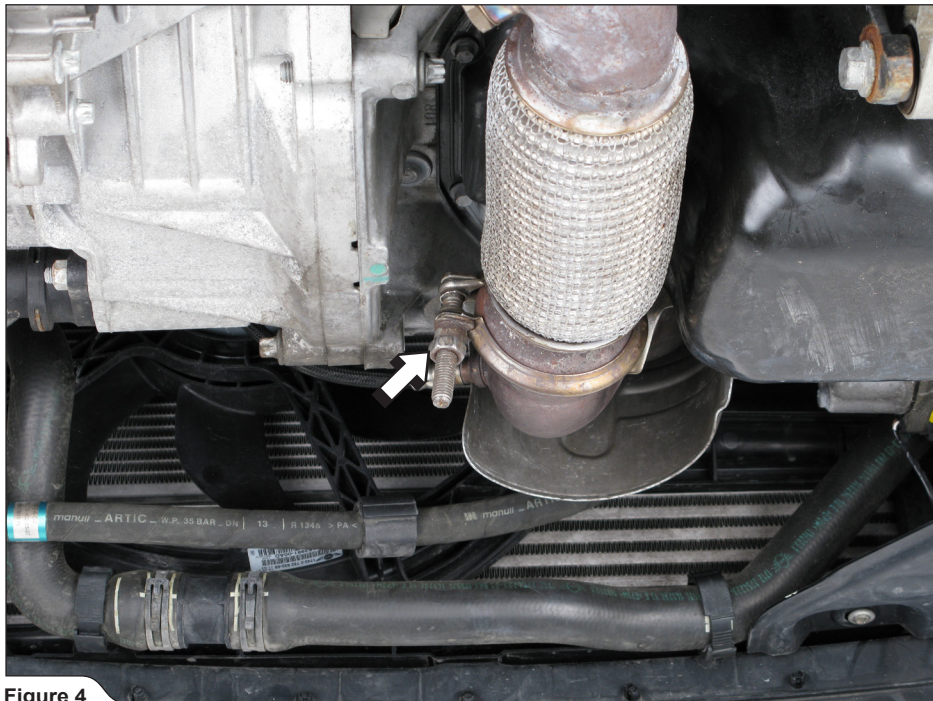

Figure 4

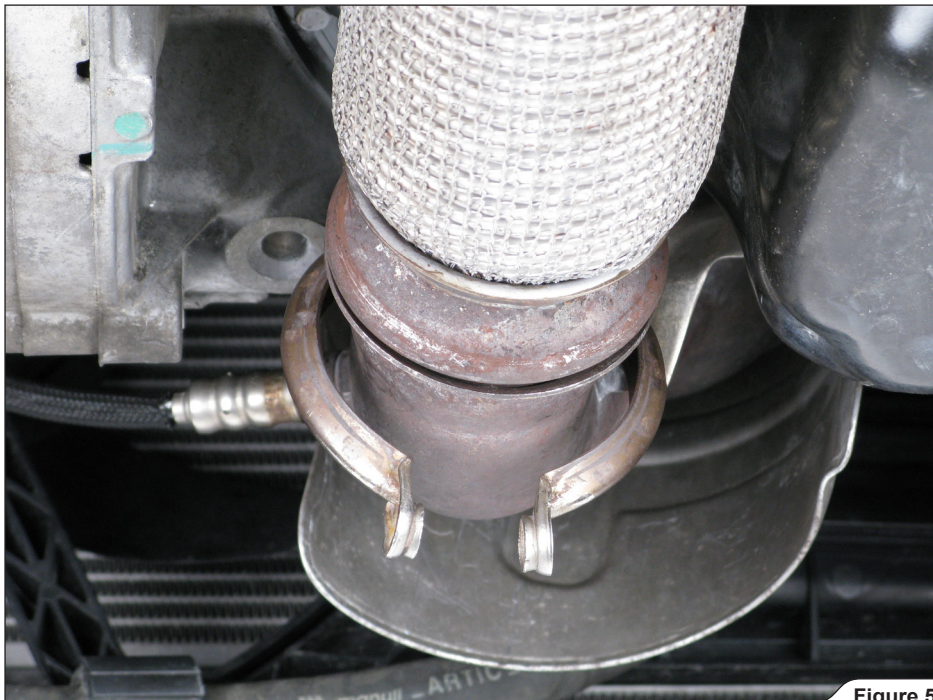

Figure 5

5. **For Evolution and Optional Down Pipe:** pull original exhaust brackets out of marked rubber brackets and remove the original exhaust system off the vehicle (**Figure 6, 7**).

! **WARNING:** make sure, that original exhaust system is supported during removal!

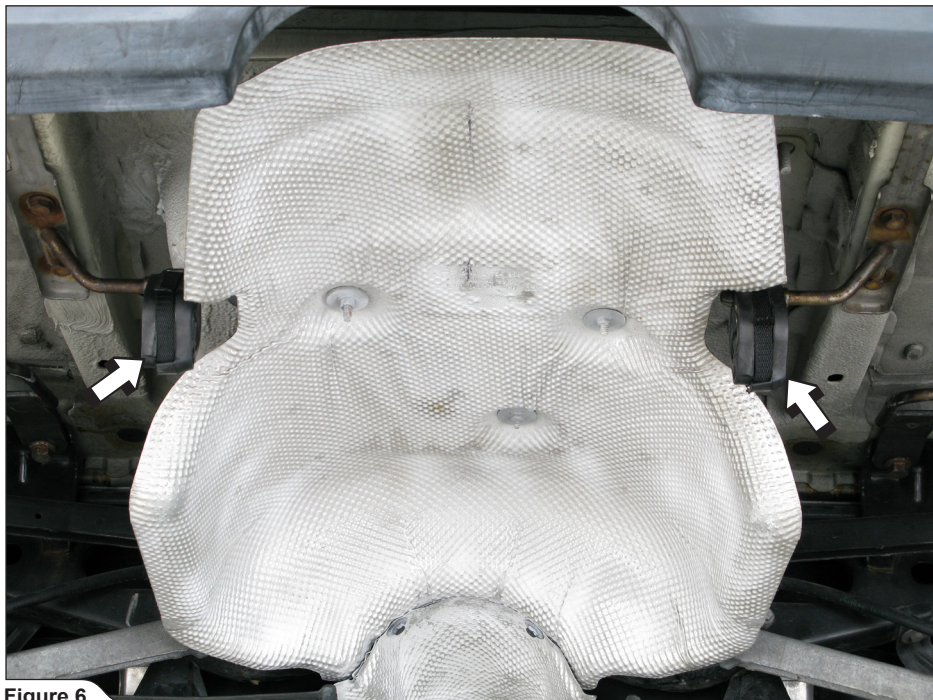

Figure 6

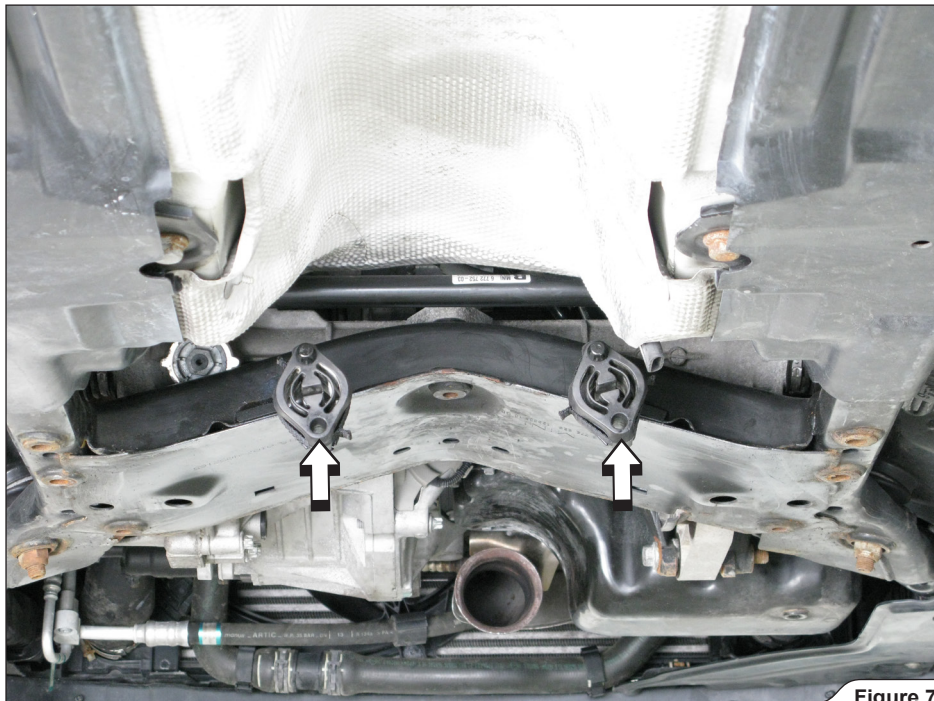

Figure 7

6. **For Optional Down Pipe only:** undo the lambda sensors' electrical lead, unscrew the lambda sensor, unscrew and remove the upper heat shield (**Figure 8**).

! **WARNING:** be careful not to damage the electrical lead of the lambda sensors during this process!

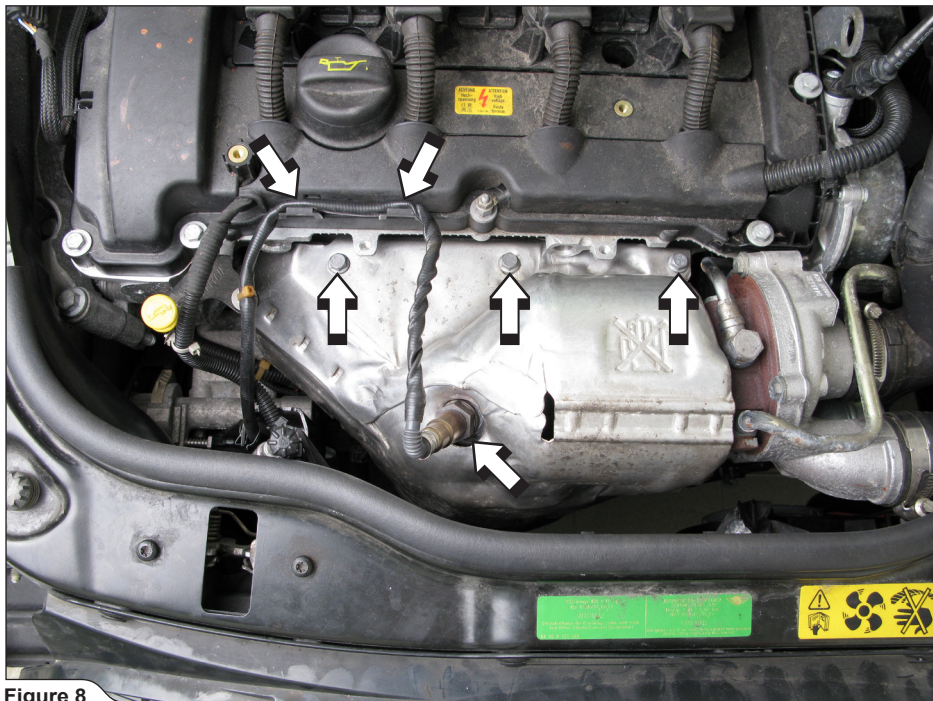

Figure 8

7. **For Optional Down Pipe only:** unscrew the marked double ended stud bolts out of the turbine casing (Figure 9).

! **WARNING:** be careful not to damage the threads or casted casing of the turbine during removal of the double ended stud bolts!

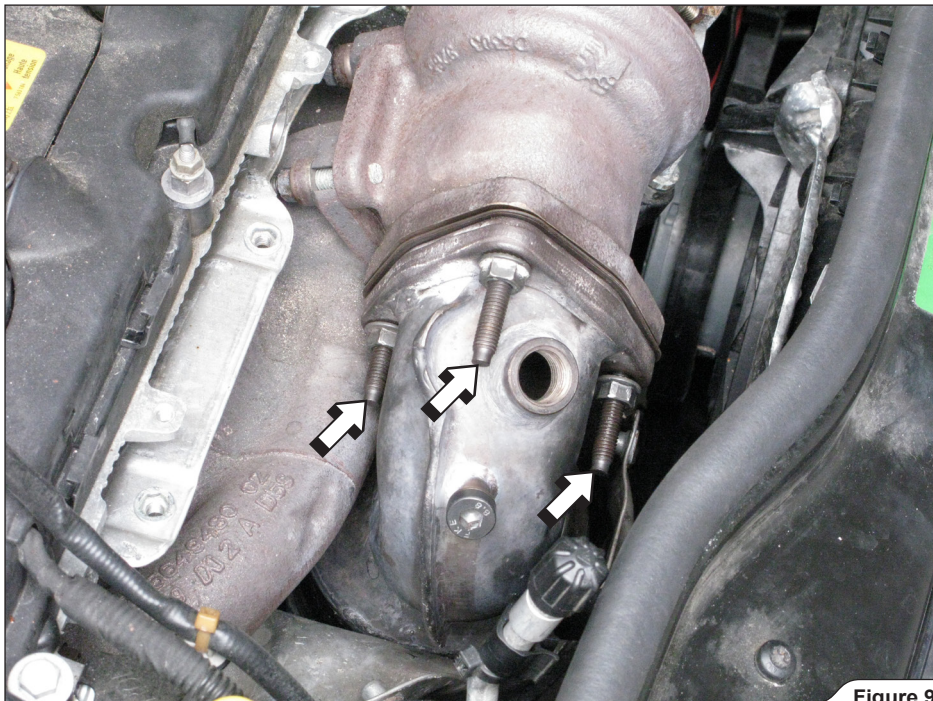

Figure 9

8. **For Optional Down Pipe only:** unscrew the lower lambda sensor and down pipes' bracket (Figure 10). Remove the down pipe off the vehicle.
- ! **WARNING:** make sure, that you support the original down-pipe during this process or you could injure yourself or damage the vehicle!
- ! **WARNING:** be careful not to damage the electrical lead of the lambda sensors during this process!

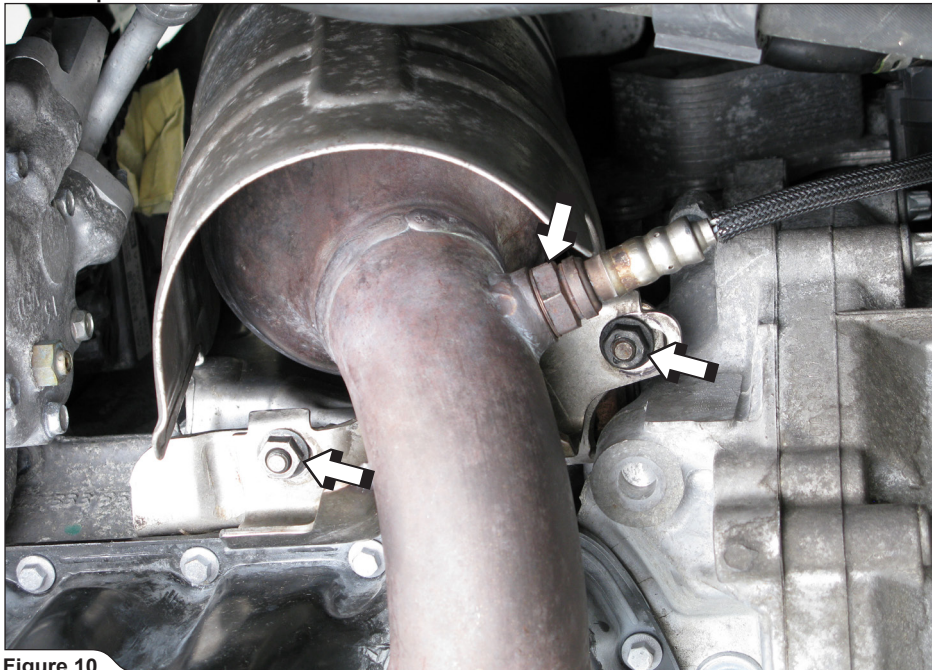

Figure 10

INSTALLATION OF THE AKRAPOVIČ EXHAUST SYSTEMS:

1. **For Optional Down Pipe only:** assemble the Akrapovič Down Pipe in the reverse order from the order in which the stock was removed. Tighten the lower lambda sensor (Figure 11, 12).
- ! CAUTION:** use new exhaust gasket in Akrapovič Down Pipe - turbine joint!
- ! WARNING:** use anti-seize copper paste on all bolt, nut and lambda threads!
- ! WARNING:** first hand tighten all Down Pipe's bolts and nuts, then fully tighten them to a specified torques using criss-cross pattern in three steps!

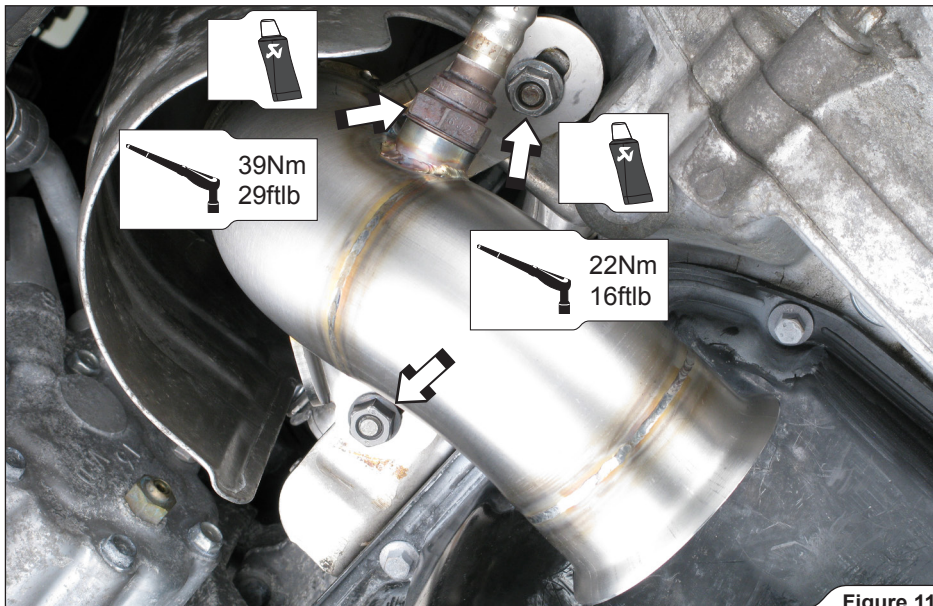

Figure 11

! **WARNING:** be careful not to damage the threads or casted casing of the turbine during installation of the double ended stud bolts!

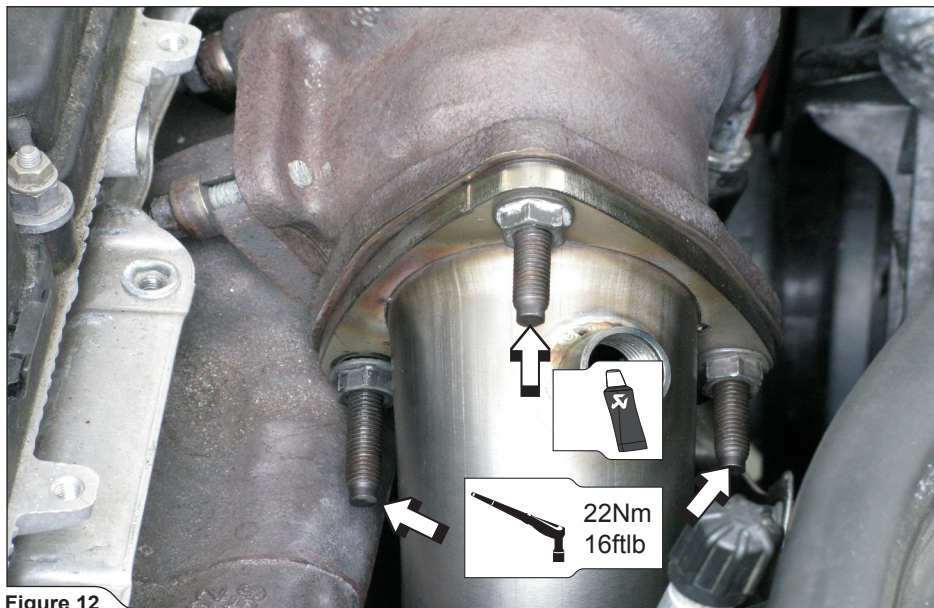

Figure 12

2. **For Optional Down Pipe only:** install the original upper heat shield and lambda sensor (Figure 13). Fasten the lambda sensors' electrical lead.

! **WARNING:** use anti-seize copper paste on lambda sensor and all bolt threads!

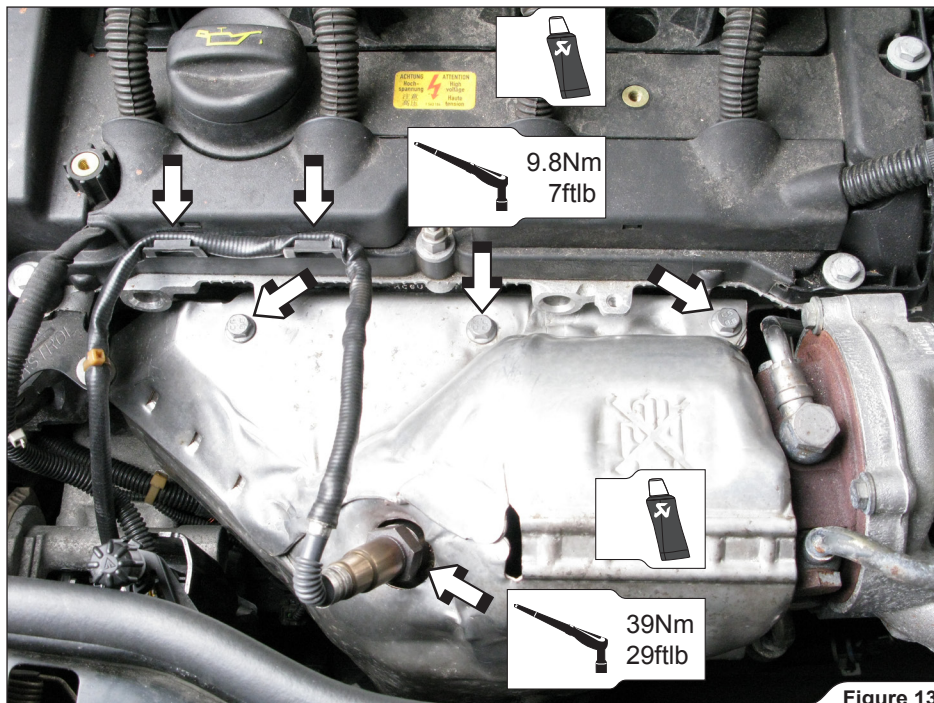

Figure 13

3. **For Evolution:** attach the Akrapovič link pipe on the down pipe, using original clamp and original rubber brackets (**Figure 14**).

! **WARNING:** use anti-seize copper paste on clamps' nut threads!

! **WARNING:** do not fully tighten the clamp yet!

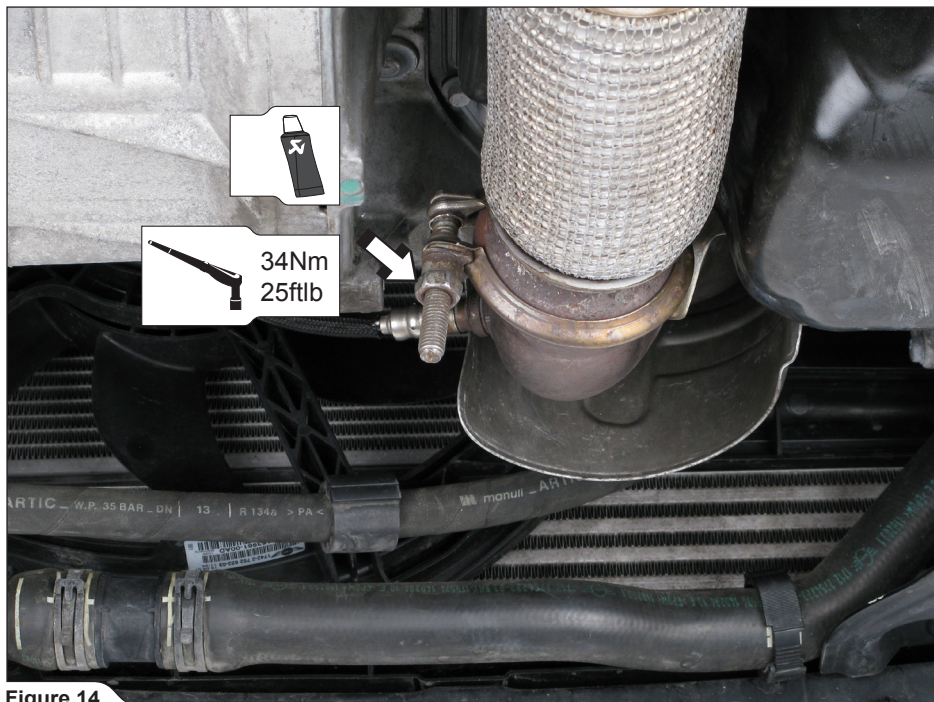

Figure 14

4. **For Evolution:** attach additional metal clamp to Akrapovič resonator, as shown (**Figure 15**).
! **WARNING:** use anti-seize copper paste on clamp bolt threads!



Figure 15

5. **For Evolution:** tighten the additional rubber dampers onto the resonator (**Figure 16**).
! **WARNING:** use anti-seize copper paste on nut threads!

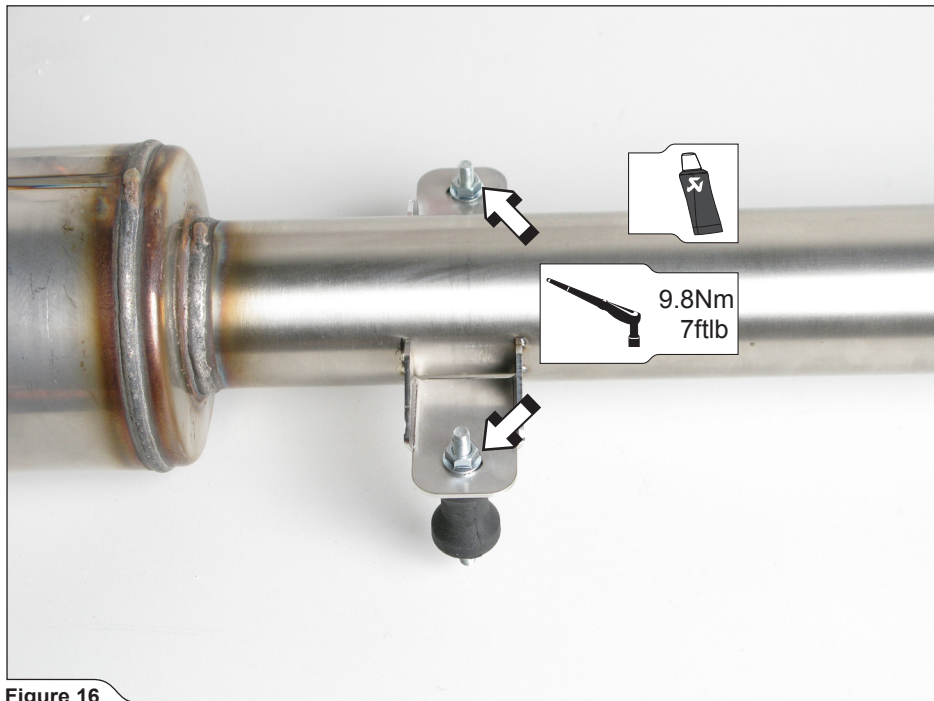

Figure 16

6. **For Evolution:** slide the resonator all the way onto the link pipe (Figure 17).

W **INSTALLATION TIP:** for easier mounting, lubricate the stock rubber brackets.

! **WARNING:** do not fully tighten the clamp yet!

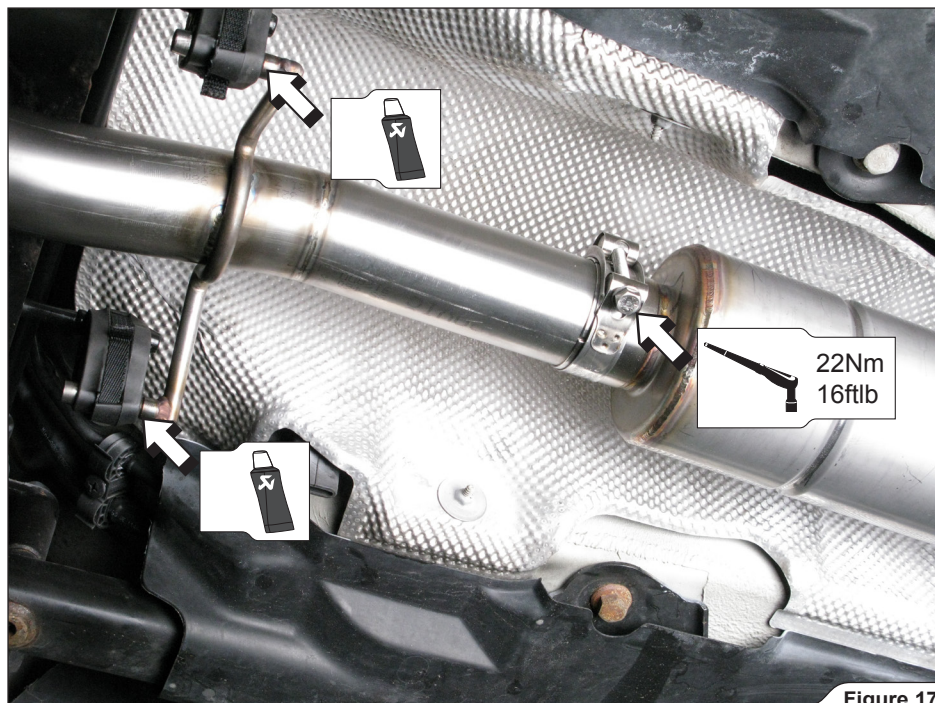

Figure 17

7. **For Evolution:** mark the inlet pipe of the Akrapovič muffler (45mm) as shown, so you can correctly adjust the fitting clamp later (**Figure 18**). Slide the fitting clamp over the pipe.

! **WARNING:** use anti-seize copper paste on all clamp bolt threads!

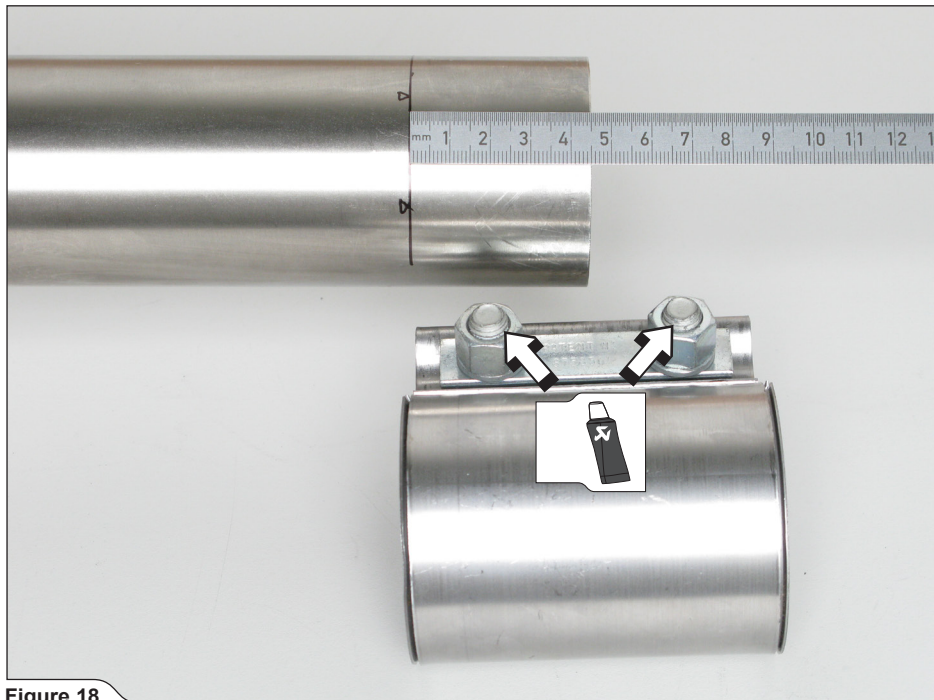

Figure 18

8. **For Evolution:** hang the muffler on stock rubber brackets as shown (Figure 19).
✂ **INSTALLATION TIP:** for easier mounting, lubricate the stock rubber brackets.

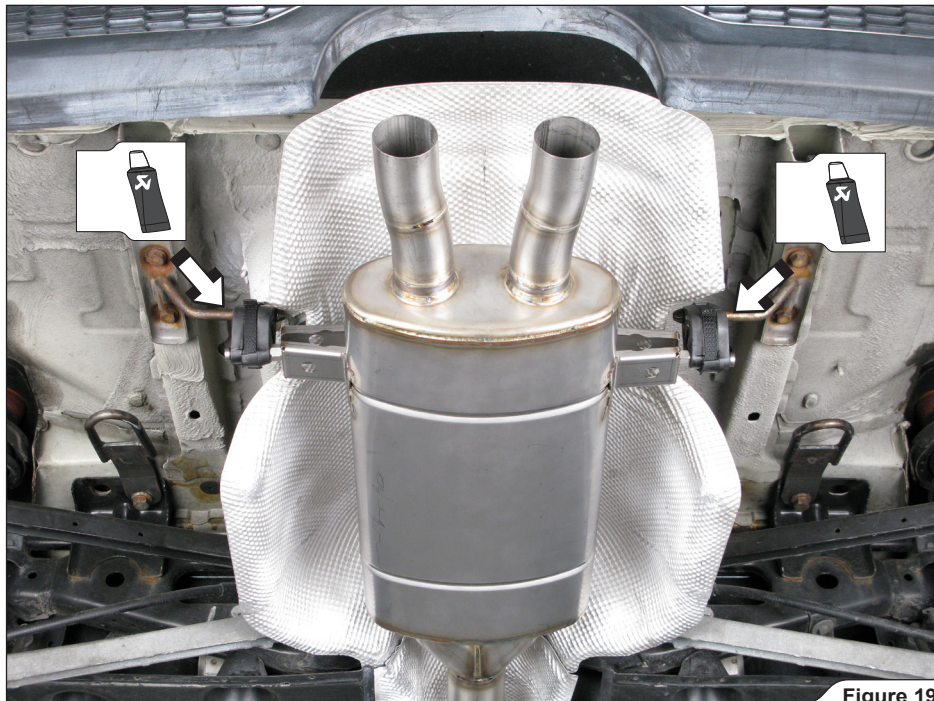

Figure 19

9. **For Evolution:** adjust the link pipe, resonator and muffler so, that the pipes, resonator or muffler don't touch any part of the vehicle (**there should be at least 10mm gap at any point**) and tighten to specified torques all clamps (**Figure 14, 17, 20**). Reattach the reinforcement plate (**Figure 20**).
- ! **WARNING:** use anti-seize copper paste on all bolt threads!

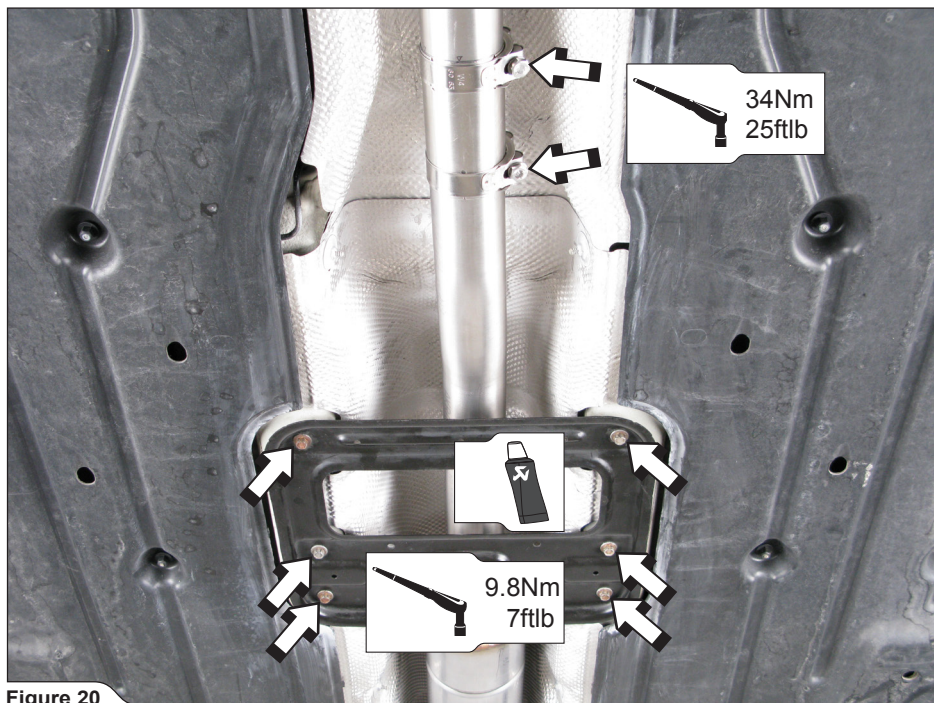

Figure 20

10. **For Evolution:** tighten the additional rubber dampers onto the reinforcement plate (**Figure 21**).
! WARNING: use anti-seize copper paste on nut threads!

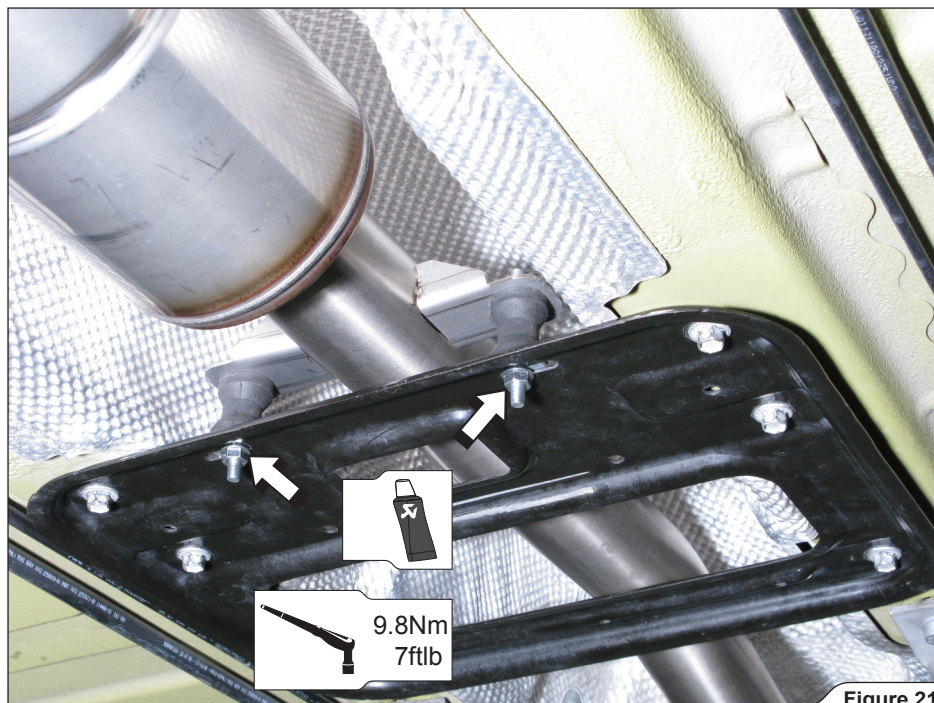

Figure 21

11. **For Evolution:** assemble the clamps onto the Tail Pipes as shown (Figure 22).
! WARNING: use anti-seize copper paste on clamp bolt threads!



Figure 22

12. **For Tail Pipes only:** assemble the clamps onto the Tail Pipes and additional reduction bushes, as shown (Figure 23).

! **WARNING:** use anti-seize copper paste on clamp bolt threads!



Figure 23

13. **For Tail-Pipes and Evolution:** slide the Akrapovič Tail Pipes onto the muffler outlets. Center them in respect to rear bumper and according to your personal taste (**Figure 24**).

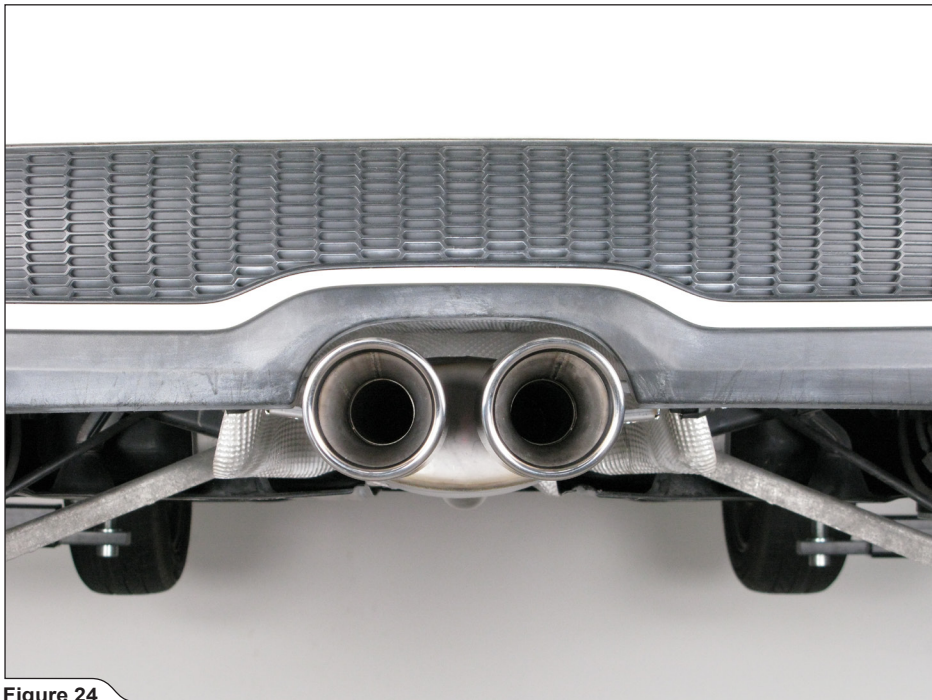

Figure 24

14. **For Tail Pipes and Evolution:** tighten Tail Pipes' clamps to a specified torque (**Figure 25**).



Figure 25

Final installation:

- ! **WARNING: check vehicle manufacturer manual for tightening torques (for dismantled stock parts)!**
- ! **WARNING: make sure all the nuts and bolts are sufficiently tightened. In case the exhaust system touches the cowling or other parts, repeat the adjustment of the exhaust system or contact your authorized dealer.**

MAINTENANCE OF THE AKRAPOVIČ EXHAUST SYSTEM:

1. Clean the titanium exhaust components with a multi-purpose spray lubricant (WD-40 or equivalent), carbon fiber exhaust components with soft and dry cloth and stainless steel components with soft cloth sprayed with contact cleaner, then wipe with soft and dry cloth. A change in the color of the exhaust system is normal due to high temperatures.
2. Periodically make sure all the bolts and springs are sufficiently tight.

- ! **WARNING: clean all exhaust components before the first start of the engine or the stains will burn onto the surfaces!**
- ! **IT IS NORMAL IF WHITE SMOKE COMES OUT OF THE MUFFLER ON FIRST OPERATION.**
- ! **DO NOT STAND BEHIND THE MUFFLER ON FIRST OPERATION.**
- ! **DO NOT USE AUTOMOTIVE WHEEL CLEANERS OR ANY CLEANING PRODUCTS WHICH CONTAIN ACIDIC ADDITIVES TO CLEAN AKRAPOVIČ EXHAUST SYSTEMS.**

www.akrapovic.com



502497