



Installation instructions

Akrapovič Exhaust System:

Slip-On

for the

Porsche 911 Turbo (type 991)

Porsche 911 Turbo S (type 991)

ENGLISH

Version 1.0

03/2016



www.akrapovic.com



Installation instructions

Akrapovič Exhaust System:

Slip-On

for the

Porsche 911 Turbo (type 991)

Porsche 911 Turbo S (type 991)

ENGLISH

Version 1.0

03/2016

www.akrapovic.com

Congratulations on purchasing the Akrapovič exhaust system. The Akrapovič exhaust system is a product of Akrapovič d.d., Malo Hudo 8a, 1295 Ivančna Gorica, Slovenia ("Akrapovič").

Please read this entire installation manual carefully prior to installing and using the Akrapovič exhaust system.

Akrapovič exhaust system should only be installed by persons skilled in car exhaust system installation and performance. The instructions provided in this manual should be followed to ensure proper installation and safe use of the Akrapovič exhaust system. Akrapovič and/or its partners shall not be held liable for any damage or personal injury (including direct, indirect, or consequential damage) sustained as a result of improper installation of the Akrapovič exhaust system or its use and maintenance contrary to the instructions and warnings contained herein.

If you have any questions regarding the installation and/or proper use of the Akrapovič exhaust system or this manual, please contact your local Akrapovič partner.

For more information on the Akrapovič exhaust systems, see the official Akrapovič website at: <http://www.akrapovic.com>

GENERAL INFORMATION

Your safety is our number one priority. Please drive your car responsibly, safely and always obey local traffic rules.

All statements made with regard to the exhaust system's compliance are made in respect of the exhaust system "as is". Any modifications of the Akrapovič exhaust system or its improper installation, use or maintenance that is not in accordance with this Installation manual, may result in severe damage to the exhaust system and/ or engine, as well as personal injury, and may affect the exhaust system's compliance with the legal requirements, such as exhaust system's air and/ or noise emissions (as an example, the car may not be suitable for use on public roads any longer), as well as warranty coverage.

The exhaust system may only be used in accordance with relevant laws and regulations, including state and federal, where applicable.

Damage caused by improper installation, use and maintenance of the Akrapovič exhaust system is not covered by the Akrapovič warranty. Please refer to the enclosed warranty with regard to the terms of our warranty.

Technical specifications of Akrapovič exhaust systems and related products are subject to change without notice.

COPYRIGHT AND OTHER RIGHTS NOTICE

The Akrapovič trademark, including corporate logos and emblems, are subject to copyright as well as trademark rights of Akrapovič, its licensors, or third persons authorizing Akrapovič to use them.

Any reproduction, technical or other manipulation, translation, or other use of the copyright and/or trademark rights contained herein is prohibited without the explicit prior written consent of Akrapovič. The same especially applies to the entire contents of this manual and/or any of its parts, including but not limited to technical specifications, instructions, graphs, photographs, and so on included in this manual.

Akrapovič takes all copyright and other rights infringement cases under serious consideration. If you have any reason to believe that your exhaust system is not an original Akrapovič product, please contact our local partners or Akrapovič at info@akrapovic.com.

SAFETY AND COMPLIANCE WARNING, PLEASE READ CAREFULLY

BEFORE REMOVING THE STOCK EXHAUST SYSTEM AND BEGINNING THE INSTALLATION OF YOUR NEW AKRAPOVIČ EXHAUST, PLEASE MAKE SURE THAT ALL ITEMS LISTED BELOW ARE VERIFIED:

- This manual is specific to the car indicated on the cover page, for which it is designed. Installation procedures vary depending on the type of car. Please verify that the Akrapovič **exhaust system and this installation manual correspond to the type of your car.**
- The exhaust system can get extremely hot during and after it is used. Make sure not to touch the exhaust system until it is completely cool. **Allow the exhaust and engine to cool down before beginning installation.**
- Make sure the car is **securely positioned to prevent** damage to yourself and other, or the car.
- Please check the parts you received against the parts list available on our website (please use the QR code on the front page or look for “schematic view” in the respective product page on www.akrapovic.com). Make sure that you have **all the parts necessary for the installation** of your new Akrapovič exhaust system. If any of the parts is missing, please do not proceed with uninstalling your stock exhaust system/installing the Akrapovič exhaust system and contact the retailer where you purchased the Akrapovič exhaust system.
- Every exhaust system muffler has its unique serial number, which identifies the authenticity of the product. You can find the serial number on the muffler's sleeve. Please refer to the **picture 1** below. Please verify that your exhaust system is an original Akrapovič product. If you have any doubts, please contact the reseller where you purchased the exhaust system or Akrapovič partners. This manual, any certificates and Akrapovič warranty apply to original products only.

GENERAL NOTE

Photographs and other illustrations in this manual are symbolic and are intended to help represent individual steps for proper installation and use, as well as for a general overview. The actual component parts of the Akrapovič exhaust system may not entirely correspond to the photographs and other illustrations.

Picture 1 - Serial Number Position

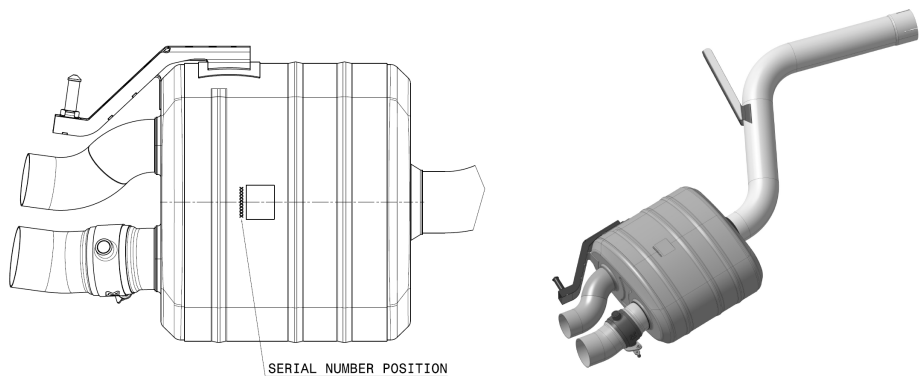

NOISE AND EMISSION WARNINGS

General warning

Because of the world-wide distribution of Akrapovič d.d. products, neither Akrapovič d.d. nor any of its subsidiaries make any representation that the exhaust system complies with the air and/or noise emissions laws, or labeling laws, of any jurisdiction. The purchasers are entirely responsible for informing themselves of the applicable laws where the products are to be used and to comply with those law.

Although legal compliance of Akrapovič products in a specific country should be determined by the user, you can find some basic guidance on compliance of your Akrapovič exhaust system with various legal requirements on the product-related part of our website (please use the QR code on the front page or look for the respective product page on www.akrapovic.com). For EC and ECE type approvals, please refer to the certificate enclosed to your product.

USA WARNING

Various U.S. states and the U.S. federal government have individual laws regulating the use of aftermarket exhaust parts and systems, especially as those parts and systems modify, remove, or replace original equipment catalysts. Please consult the appropriate laws in your area before installing any aftermarket part or system on your vehicle to ensure compliance with all applicable laws. Neither Akrapovic d.d. nor any of their subsidiaries or the sellers of the parts or systems make any representation that any of their parts or systems comply with any such laws.

CALIFORNIA WARNING

California laws prohibit the use of any aftermarket exhaust part or system that modifies, removes or replaces original equipment catalysts unless the California Air Resources Board has issued an Executive Order regarding such part or system or unless the part or system is exempted by being used only on racing vehicles on closed courses. Neither Akrapovic d.d. nor any of their subsidiaries make any representation that any of their parts or systems has received such an Executive Order or that any of their parts or systems conform with the racing vehicles exemption. The purchasers are entirely responsible for informing themselves of applicable California laws and to comply with those laws.

SYMBOLS

The following symbols are used throughout these installation instructions:



TOOLS AND PROTECTIVE EQUIPMENT REQUIRED



TIGHTENING TORQUE



LUBRICATION



HAND TIGHTEN



INSTALLATION TIP



CAUTION OR IMPORTANT

USE BOLT SEALANT

Apply 3 to 4 small drops of bolt sealant onto the cleaned and degreased threads before tightening the bolts.

WARNING! Avoid contact with skin, eyes and mucous membranes. Do not inhale fumes. Keep out of reach of children.



USE ANTI-SEIZE LEAD-FREE COPPER PASTE (black tube)

Provides trouble-free and long-lasting protection against seizing, corrosion and rusting of bolts, threaded ends, nuts, joints, etc. Also protects against vibration, wear and impact. **WARNING! Avoid eye contact. Keep out of reach of children.**



USE ANTI-SEIZING GREASE (white tube)

Prevents seizing, corrosion and excessive wear between the titanium components of your exhaust system. **WARNING! Avoid eye contact. Keep out of reach of children.**



Tools & equipment

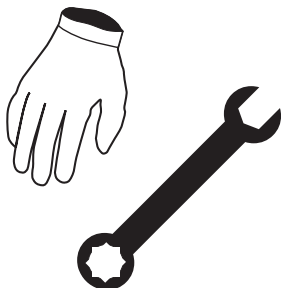

- Torx 25
- Torx 30
- Torx 45
- Ratchet combination 12 mm wrench
- Combination 12 mm wrench
- Combination 14 mm wrench
- Combination 22 mm wrench
- Socket 15 mm
- Spring puller

PARTS LIST

The following parts should be found in the box:

- Installation Manual
- Homologation certificate/ compliance documents if applicable
- Warranty
- Fitting material
- Muffler and pipes

Detailed list of parts can be found on the Akrapovič website (please use the QR code on the front page or look for "Schematic view" in the respective product page on www.akrapovic.com).

IMPORTANT: The car should be in the off position throughout the dismantling and installation process, as well as any other work done on the exhaust system!

REMOVAL OF STOCK EXHAUST SYSTEM:

The process of uninstalling the original exhaust system may vary depending on the existing exhaust system. Please follow the original exhaust system manufacturer's instructions for uninstalling the original exhaust system.

If you for any reason decide otherwise, please note that any information provided in this respect herein should be considered as general information provided for your convenience only. Akrapovič shall not assume any liability or responsibility with regard to uninstalling your existing exhaust system, warranty coverage of such exhaust system or vehicle or their further fitness for use.

In case your Akrapovič exhaust system may not be used on certain roads or under certain conditions, please keep the stock or other exhaust system that you can use in such circumstances legally.

REMOVAL OF STOCK EXHAUST SYSTEM:

Put the vehicle onto a car lift.

- ! **IMPORTANT:** ensure that the car is lifted safely and properly in order to avoid the risk of vehicle damage, injury, or even death!
- 1. Undo the rear spoiler's brackets trims, unscrew the marked bolt on both sides and carefully remove the spoiler off the vehicle (**Figure 1, 2**).
- ! **CAUTION:** make sure not to injure yourself or damage any part of the vehicle during this process!



Figure 1



Figure 2

- Carefully pull the engine compartment cooling fans off the rubber brackets, disconnect the electrical connectors and remove the fans out of the engine compartment (**Figure 3**).

! **CAUTION:** make sure not to injure yourself or damage any part of the vehicle during this process!



Figure 3

3. Remove the plastic connector cover, unscrew the marked bolts, disconnect the marked connector and carefully remove the under spoiler trim off the vehicle (**Figure 4, 5**).

! **CAUTION:** make sure not to injure yourself or damage any part of the vehicle during this process!



Figure 4

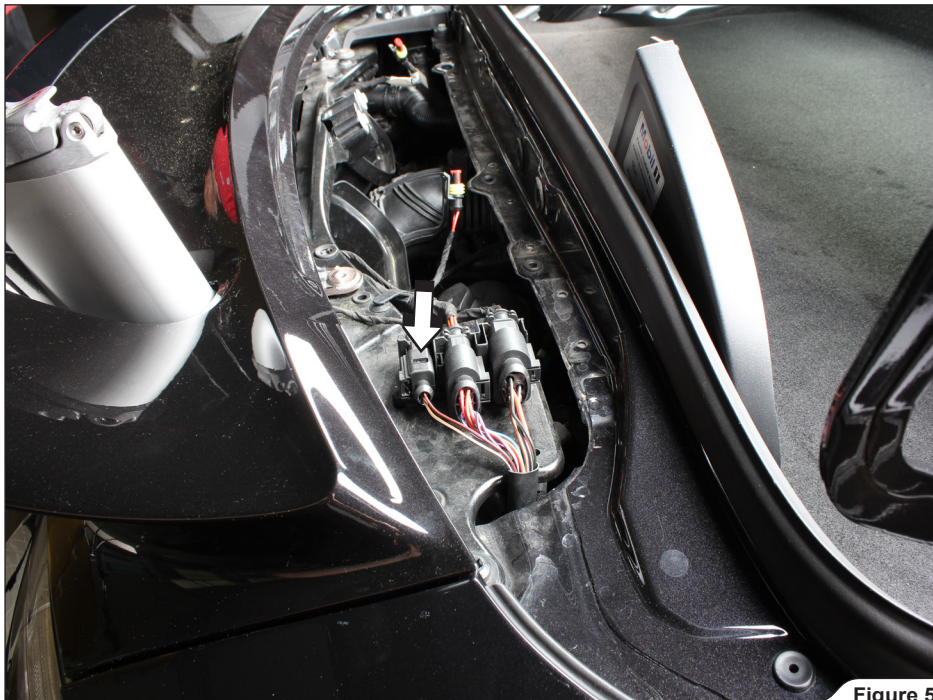

Figure 5

4. Unscrew the marked bolts on both sides, carefully pull the tail lights out of the chassis, disconnect the tail lights' electrical connectors and remove the tail lights off the vehicle (**Figure 6, 7**).
- !** **IMPORTANT:** make sure, not to damage the connectors, tail lights or any other part of the vehicle during this process!



Figure 6



Figure 7

5. Unscrew the marked rear bumper's bolts (Figure 8, 9, 10).

! **CAUTION:** make sure not to injure yourself or damage any part of the vehicle during this process!



Figure 8



Figure 9

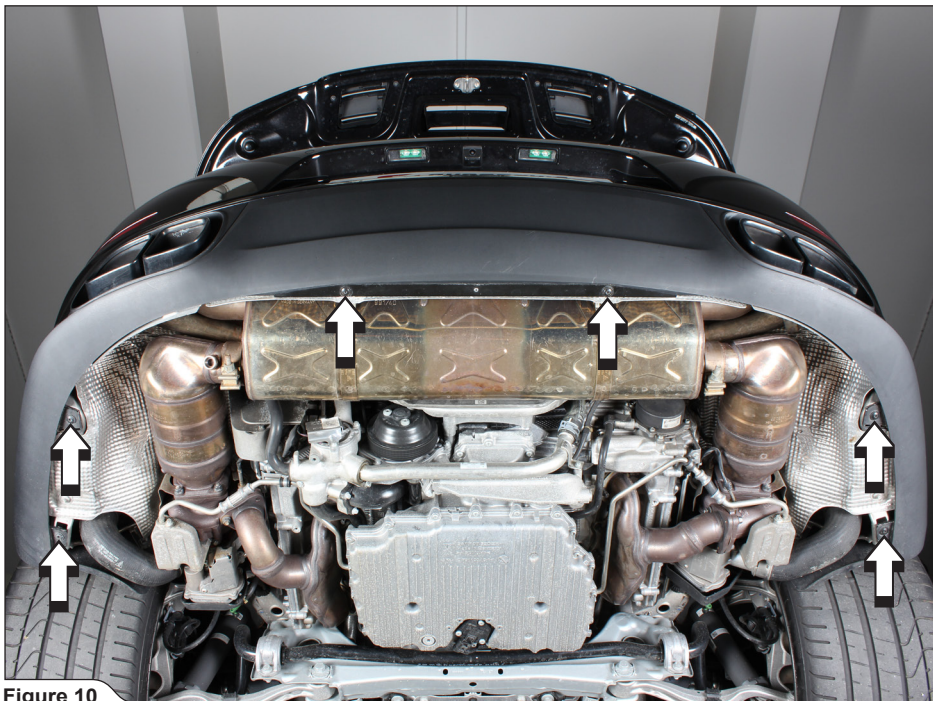

Figure 10

6. Remove both rear wheels and unscrew rear parts of the wheel arch panels on both sides of the vehicle (**Figure 11, 12, 13**).

! **CAUTION:** make sure not to injure yourself or damage any part of the vehicle during this process!



Figure 11

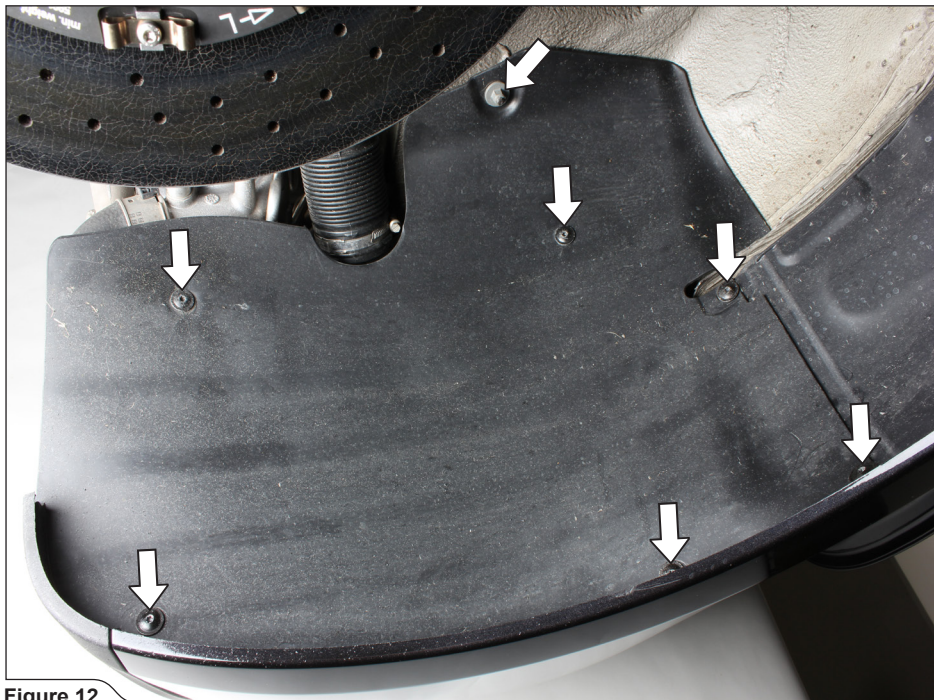

Figure 12



Figure 13

7. Disconnect the bumpers' electrical connector, and carefully remove the bumper off the vehicle (Figure 14, 15).

! **IMPORTANT:** make sure, not to damage the connectors, bumper or any other part of the vehicle during this process!



Figure 14



Figure 15

8. Unscrew the marked bolts on both sides and remove the impact absorber (**Figure 16**).
- ! **CAUTION:** make sure not to injure yourself or damage any part of the vehicle during this process!



Figure 16

9. Loosen the marked muffler's tape clamps, unscrew all nuts of the link pipes flanges and the bolts of turbo chargers' heat shield on both sides of the engine (Figure 17, 18).

! **CAUTION:** make sure, that you support the muffler and stock link pipes during this process or you could injure yourself or damage the vehicle!

! **CAUTION:** make sure not to injure yourself or damage any part of the vehicle during this process!

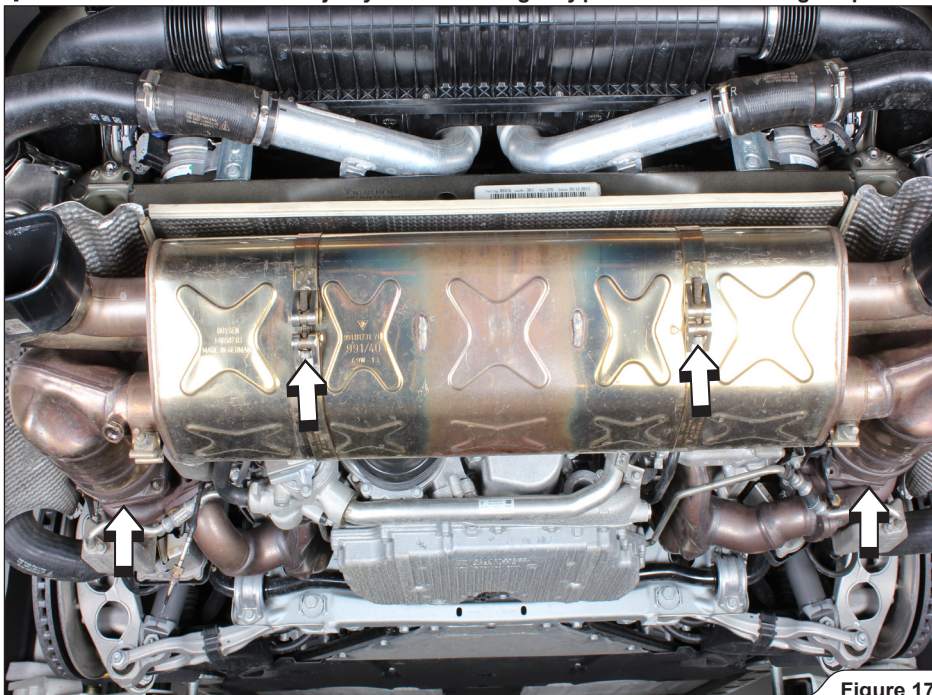

Figure 17

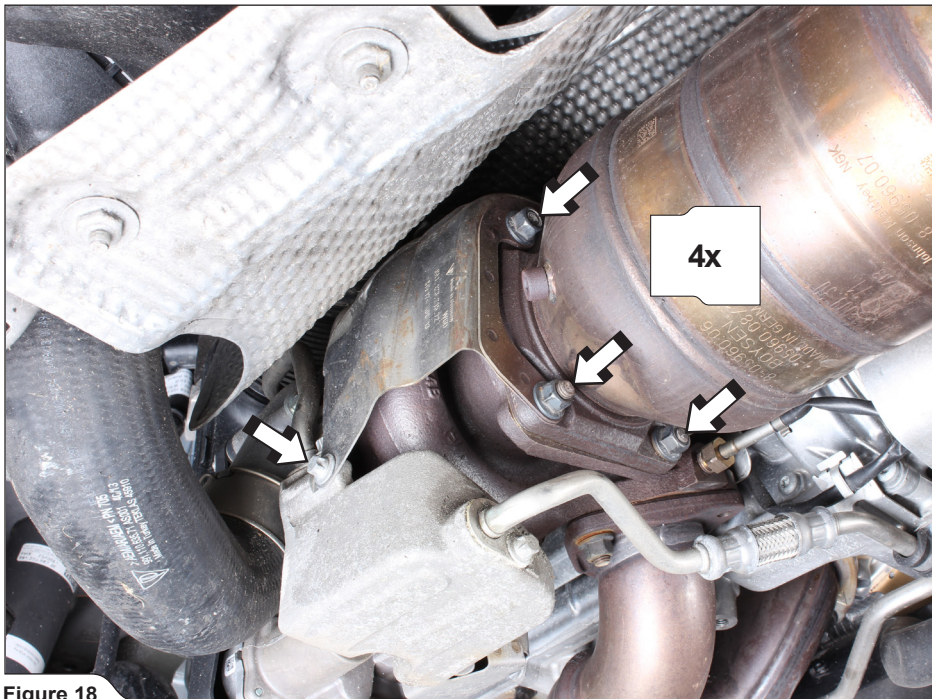

Figure 18

- Slide the muffler's tape clamps off the brackets behind the muffler and carefully lower the muffler with link pipes, until you can unscrew the lambda sensors. Unscrew all lambda sensors and remove the muffler together with link pipes and turbo chargers' heat shields off the vehicle (**Figure 19**).

! CAUTION: make sure, that you support the muffler and stock link pipes during this process or you could injure yourself or damage the vehicle!

! CAUTION: make sure not to damage the sensors' electrical leads during this process!

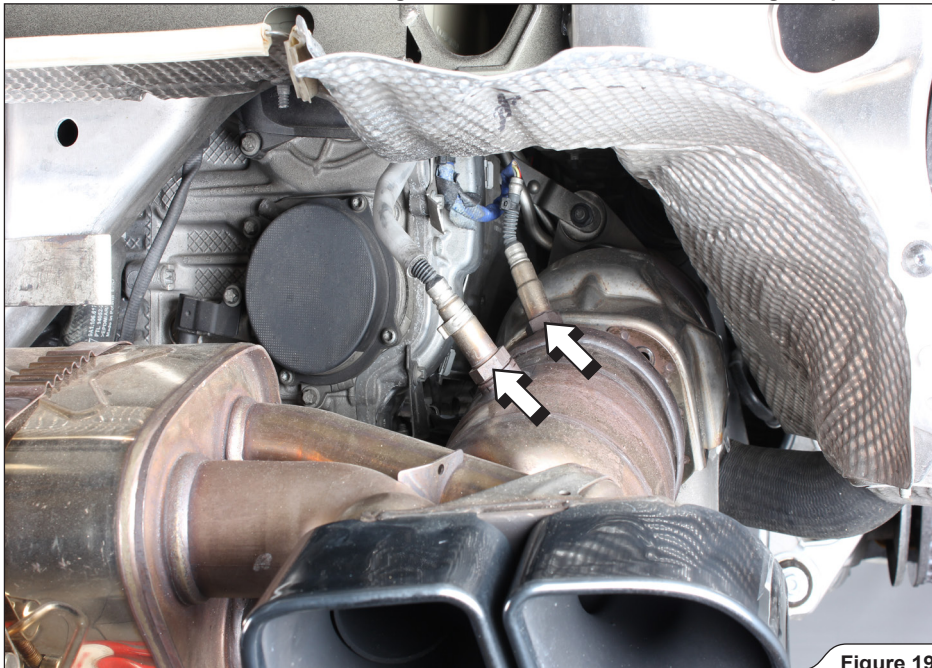

Figure 19

11. Loosen the marked clamps on both sides of the muffler and disassemble the link pipes and muffler (**Figure 20**).

! **CAUTION:** make sure not to injure yourself or damage the exhaust system during this process!



Figure 20

INSTALLATION OF THE AKRAPOVIČ EXHAUST SYSTEM:

1. Assemble the stock link pipes, turbo chargers' heat shields and Akrapovič muffler, adapters, muffler's outlet pipes and muffler's tape clamps as shown; use clamps from Akrapovič installation kit (**Figure 21, 22**).

! **IMPORTANT:** hand tighten all clamps only!



Figure 21

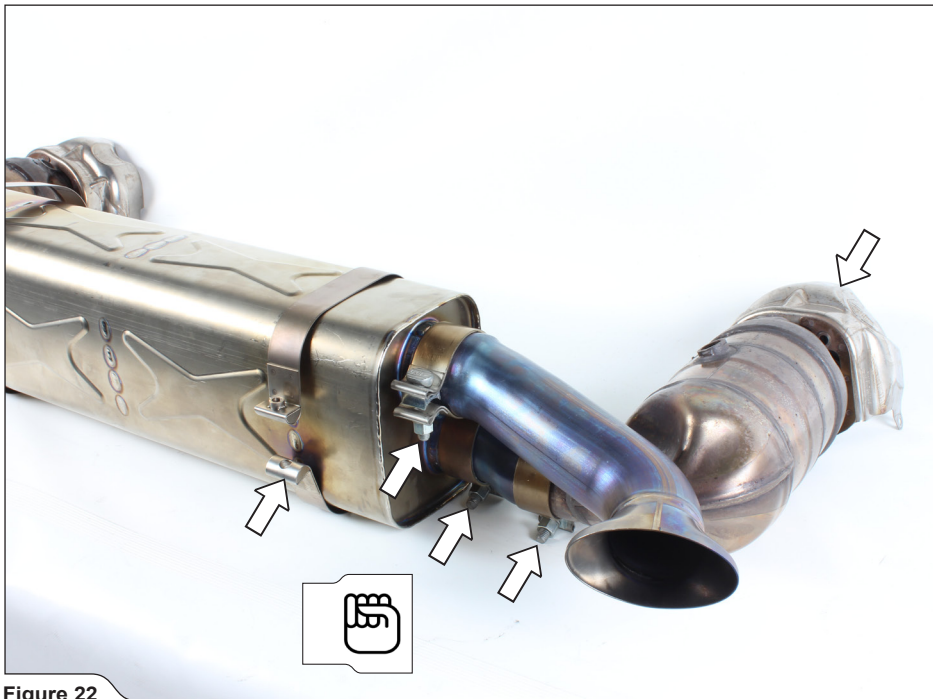

Figure 22

- Partially install the assembled muffler/stock link pipes onto the vehicle as shown and tighten all lambda sensors into the link pipes (**Figure 23, 24**).

! **CAUTION:** support the assembled muffler/link pipes safely during this process or you could injure yourself or damage the vehicle!

! **IMPORTANT:** use new gaskets in link pipes - turbo chargers joints!

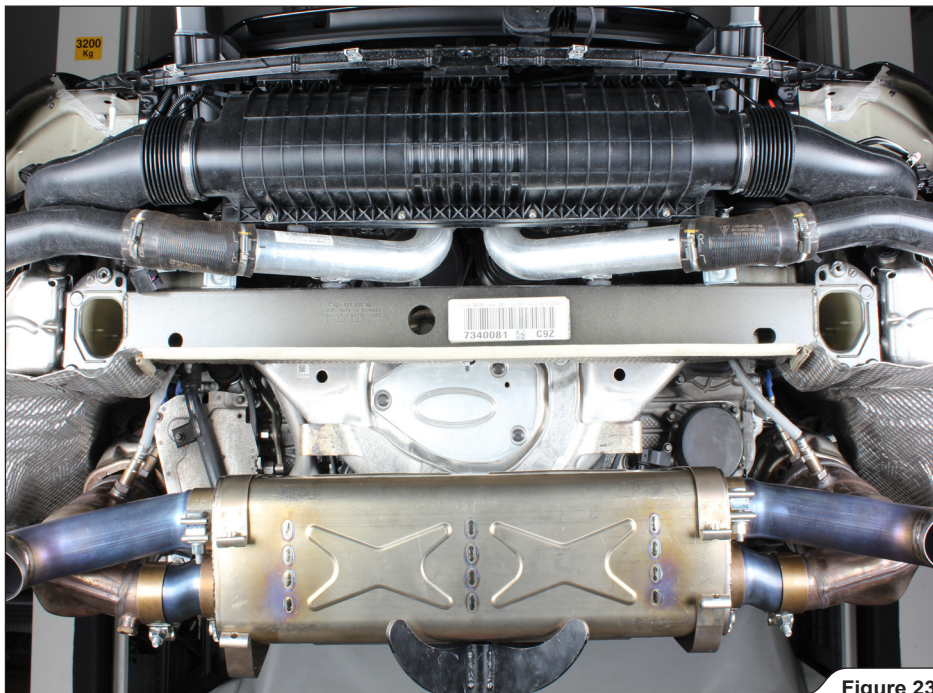

Figure 23

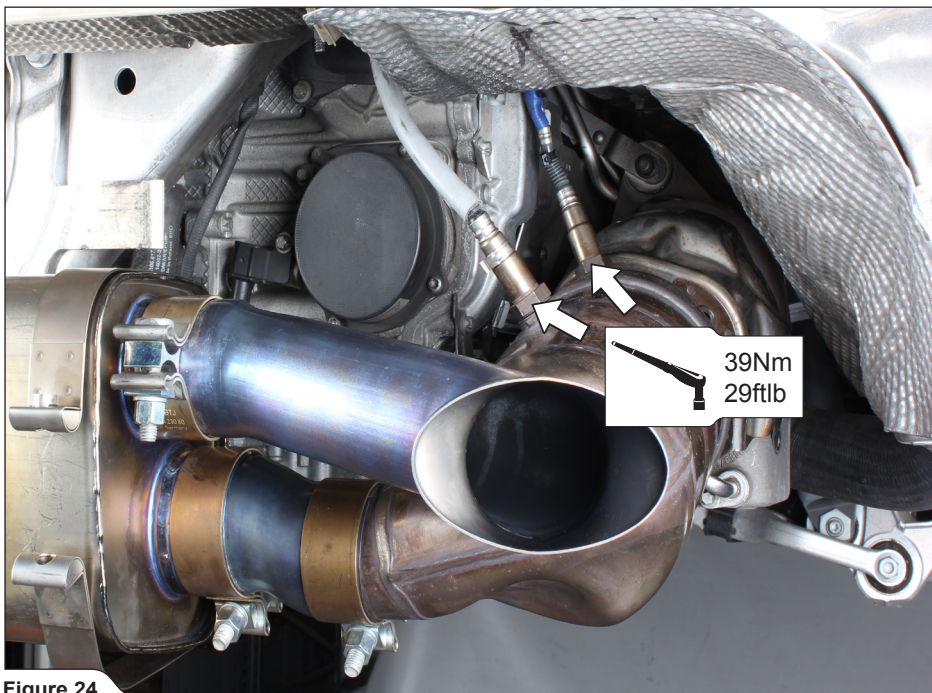

Figure 24

3. Align and center the muffler, so the muffler brackets align with muffler's position restrictors; attach the muffler's tape clamps over the brackets, as shown (Figure 25, 26).

! **IMPORTANT:** make sure that muffler bracket and link pipes are correctly joint with muffler - use rubber mallet, if necessary, to tap the connections into place!

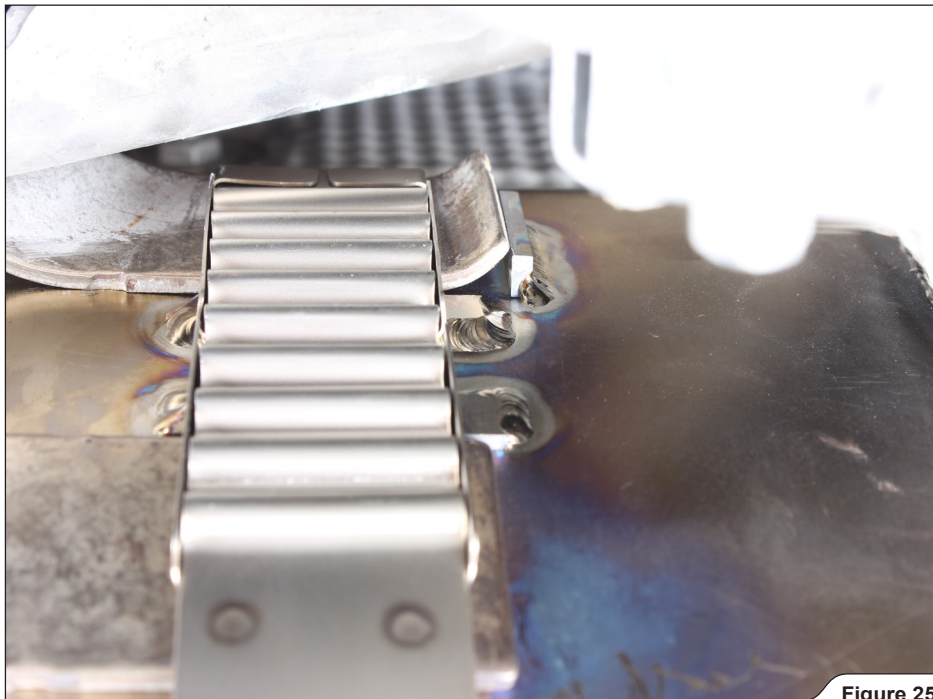

Figure 25

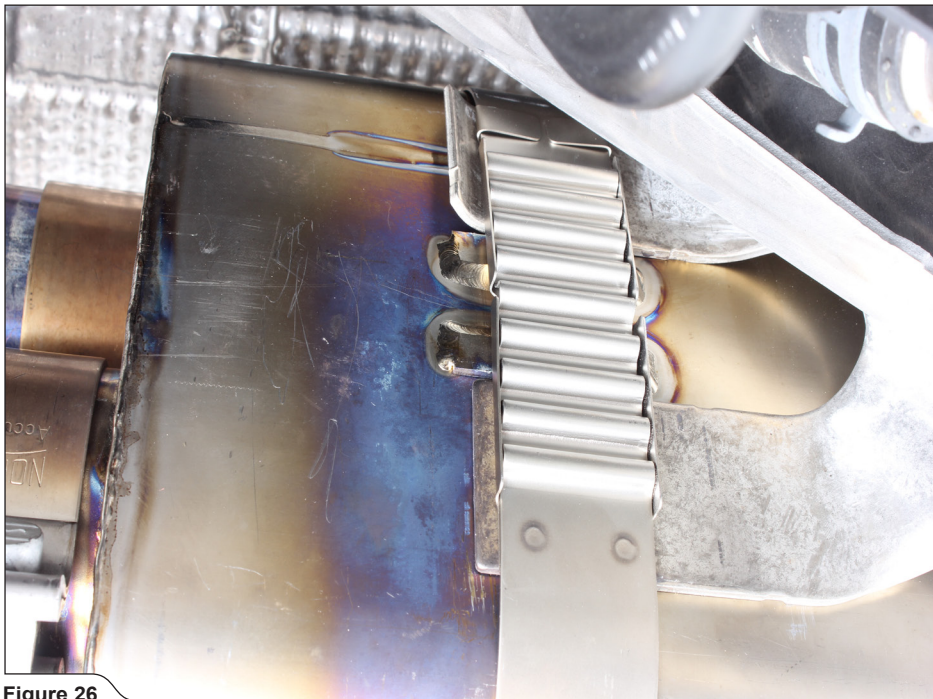

Figure 26

4. Tighten the muffler clamps to the specified torque (**Figure 27**).

! **IMPORTANT:** before tightening the clamps, recheck the muffler and muffler bracket position; realign and center the muffler if necessary!

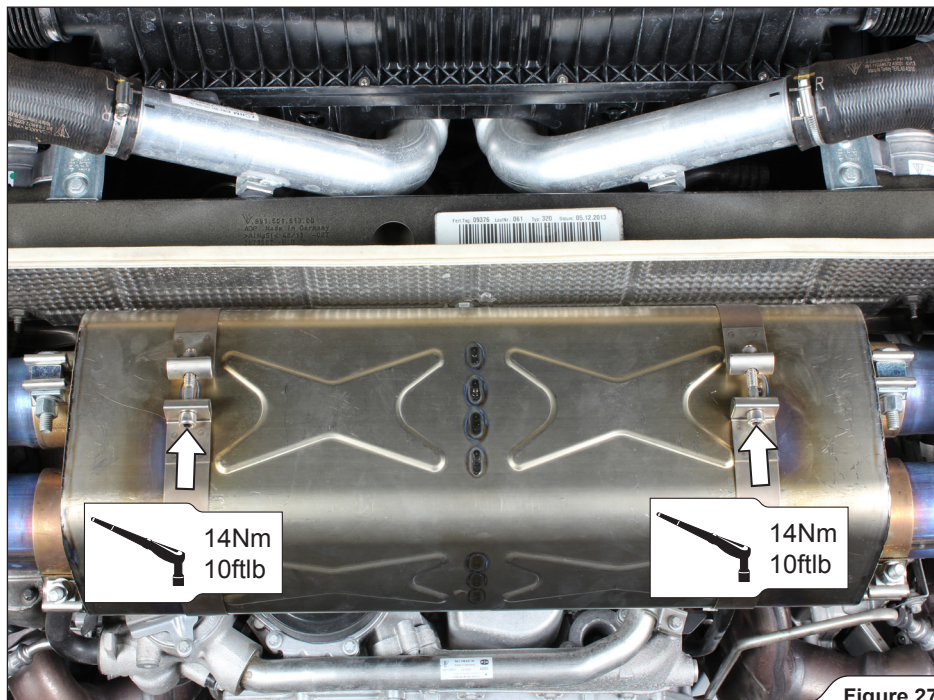

Figure 27

5. Tighten the stock link pipes' flanges (using stock nuts) and heat shields' stock bolts to a specified torques on both sides of the vehicle (**Figure 28**).

! **CAUTION:** make sure not to injure yourself or damage any part of the vehicle during this process!

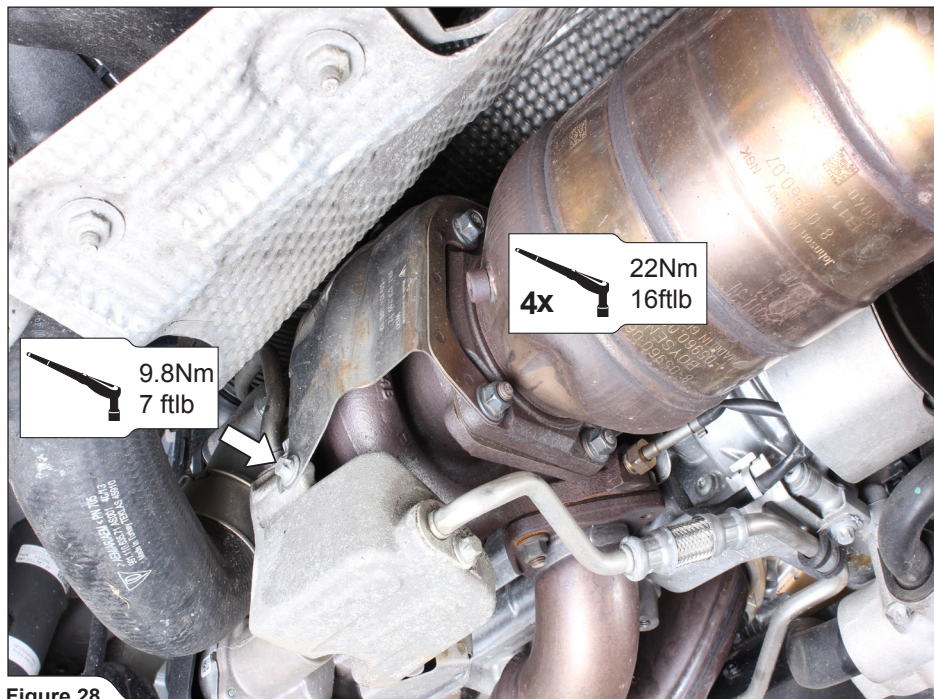

Figure 28

6. Tighten the marked clamps to a specified torque, on both sides of the vehicle (**Figure 29**).

! **INSTALLATION TIP:** before tightening the clamps, check the alignment of the adapters with link pipes' outlets. If necessary, rotate the eccentric adapters to align muffler's inlets with link pipes.

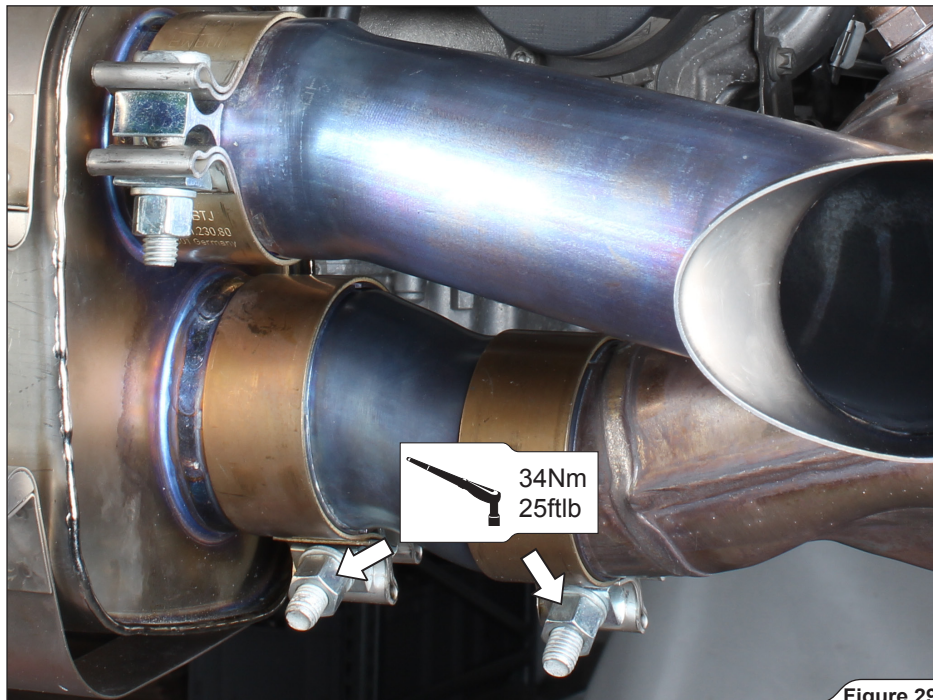

Figure 29

7. Attach the Akrapovič Tail Pipes onto the bumper, using springs from Akrapovič installation kit (Figure 30, 31, 32).

! **CAUTION:** make sure not to injure yourself or damage any part of the vehicle during this process!



Figure 30

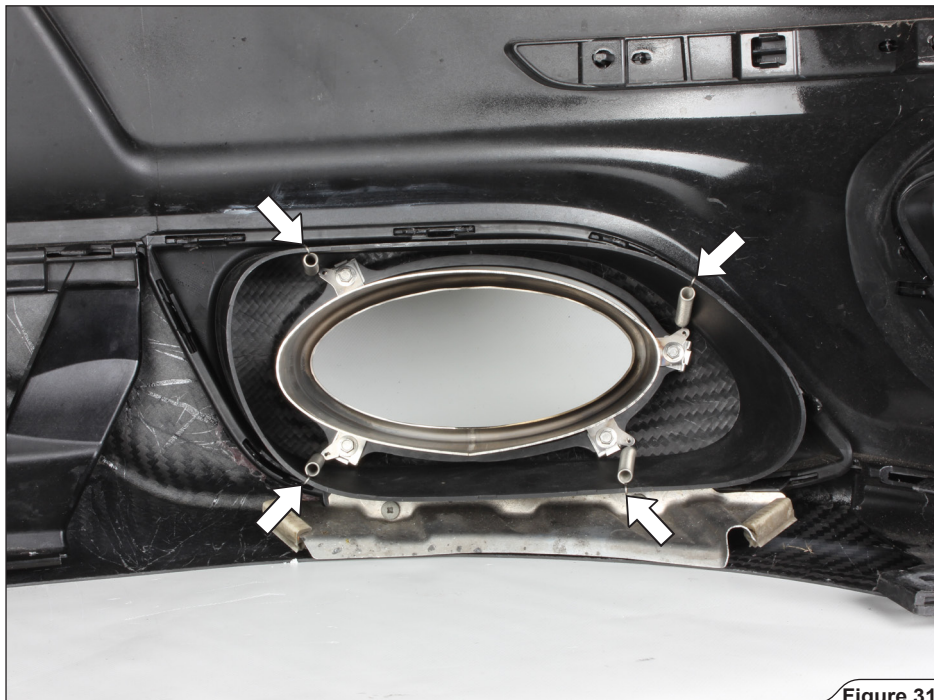

Figure 31

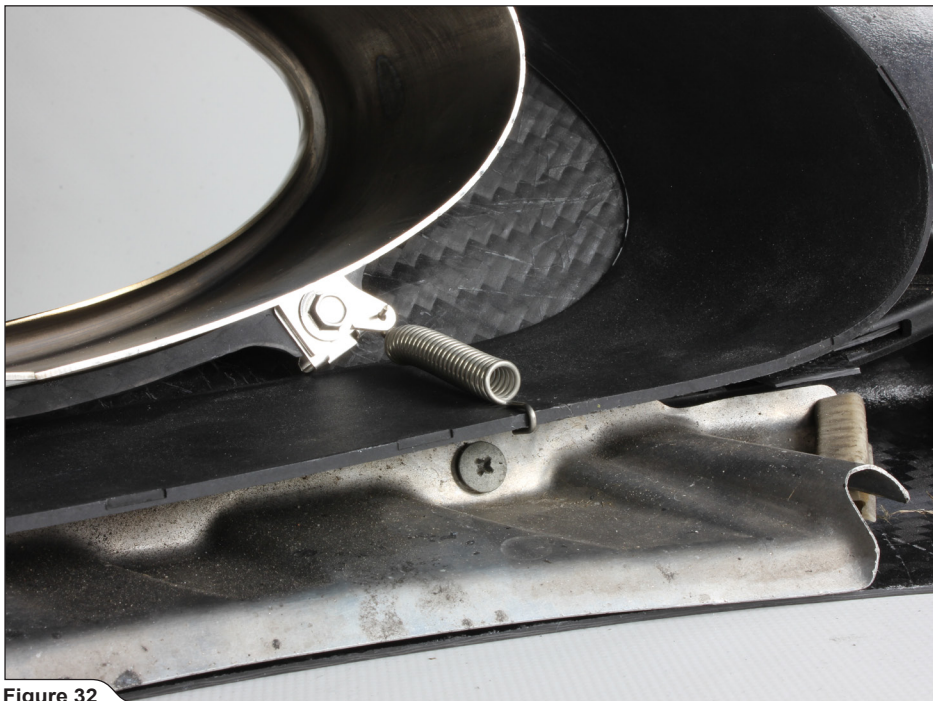

Figure 32

8. Replace all dismantled stock parts (tail lights, bumper, wheels...) in the reverse order from the order in which they were removed. Check vehicle manufacturer manual for tightening torques.
9. Align and center both muffler's outlet pipes in respect to the tail pipes and tighten marked clamps to the specified torque (**Figure 33, 34**).

! CAUTION: make sure not to injure yourself or damage any part of the vehicle during this process!

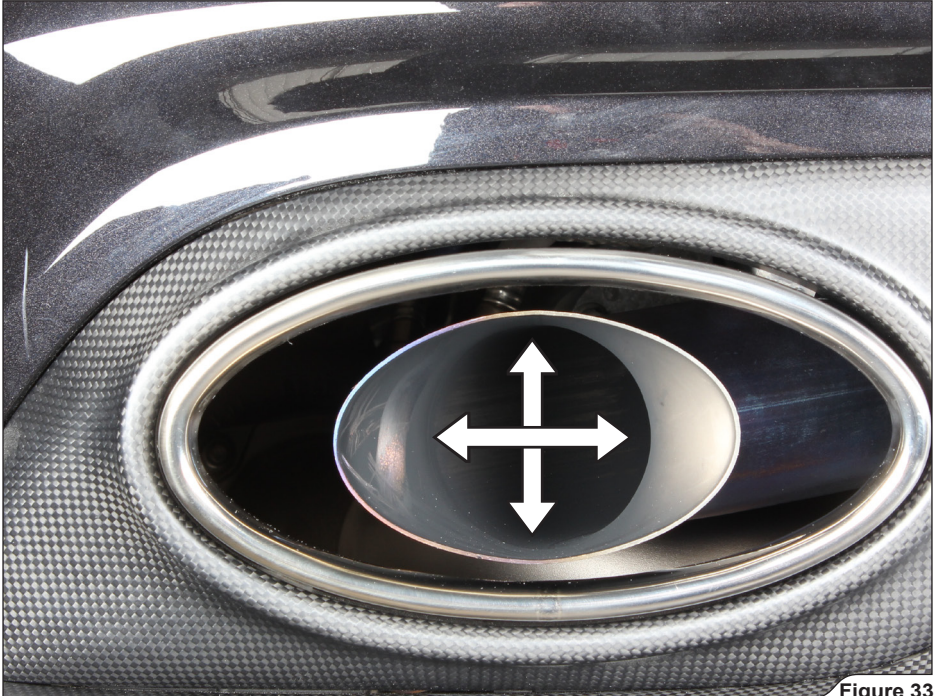

Figure 33

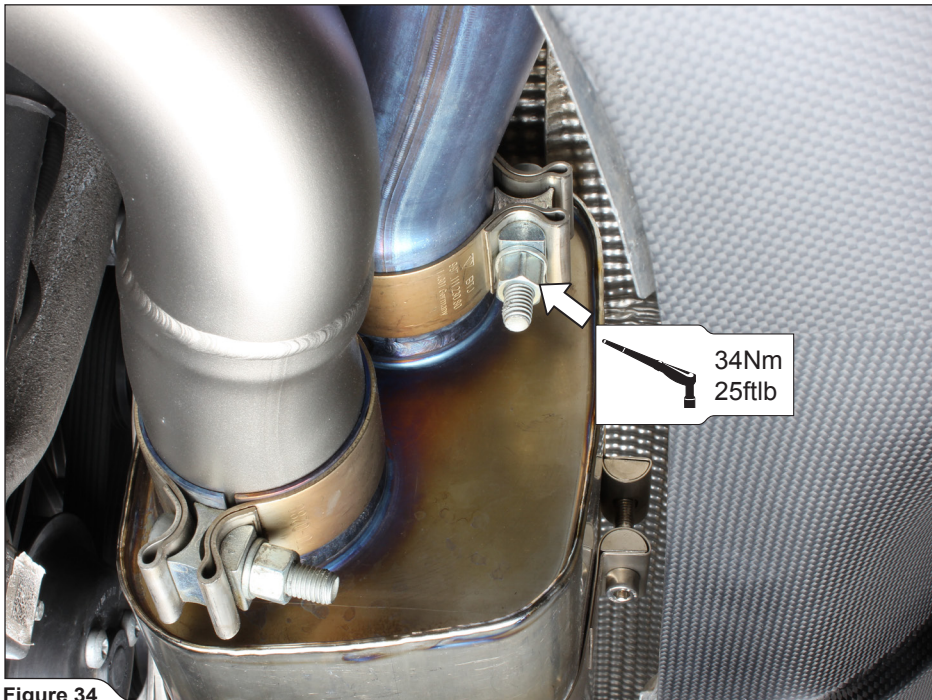

Figure 34

FINAL INSTALLATION:

- ! **IMPORTANT:** reinstall the dismantled or partially removed stock parts (wheel arches, bumper etc.); check vehicle manufacturer manual for tightening torques.
- ! **IMPORTANT:** make sure all the nuts and bolts are sufficiently tightened. In case the exhaust system touches the cowl or other parts, repeat the adjustment of the exhaust system or contact your authorized dealer.
- ! **IMPORTANT:** clean all exhaust components before the first start of the engine or the stains will burn onto the surfaces!

MAINTENANCE OF THE AKRAPOVIČ EXHAUST SYSTEM:

1. Clean the titanium exhaust components with a multi-purpose spray lubricant (WD-40[®] or equivalent)*, carbon fiber exhaust components with soft and dry cloth and stainless steel components with soft cloth sprayed with contact cleaner, then wipe with soft and dry cloth. A change in the color of the exhaust system is normal due to high temperatures.
2. Periodically make sure all the bolts and springs are sufficiently tight.

*WD-40[®] is a trademark of the WD-40 Company.



INSTALLATION TIP: IT IS NORMAL FOR WHITE SMOKE TO COME OUT OF THE MUFFLER AT FIRST OPERATION.

- ! **CAUTION:** DO NOT STAND BEHIND THE MUFFLER AT ANY TIME.
- ! **CAUTION:** DO NOT USE AUTOMOTIVE WHEEL CLEANERS OR ANY CLEANING PRODUCTS WHICH CONTAIN ACIDIC ADDITIVES TO CLEAN THE AKRAPOVIČ EXHAUST SYSTEMS.

WARNING: THE EXHAUST SYSTEM CAN BE EXTREMELY HOT. ALLOW THE EXHAUST AND ENGINE TO COOL DOWN BEFORE BEGINNING INSTALLATION OR ANY OTHER WORK ON THE EXHAUST SYSTEM. THIS MANUAL IS SPECIFIC TO THE PORSCHE 911 TURBO S M.Y. 2014. THERE MAY BE SOME DIFFERENCES IN INSTALLATION PROCEDURES FOR OTHER MODELS.

TROUBLESHOOTING:

Problem	Possible cause	Solution
Exhaust gas leaks out of the muffler/pipe clamp connections	loosened clamp	tighten the clamp to specified torque
	connection is not completely joined	tap the connection into place and tighten the clamp to specified torque
Valves are not moving	No supply	Check green LED on the Control Kit. If the LED is off: <ul style="list-style-type: none">• Check electrical connection and connectors• Check fuse for exhaust valves (in the trunk, right)
	Error detected	Check green LED on the Control Kit. If the LED is blinking fast: <ul style="list-style-type: none">• Check electrical connections and connectors• Try to use the Sound Kit remote controller. If valves are turning, then check how the Communication sensor is installed

www.akrapovic.com

