



Installation instructions

Akrapovič Exhaust Systems:
Slip-On and Evolution
for the
BMW M3 (type E90, E92, E93)



Installation instructions

Akrapovič Exhaust Systems:
Slip-On, Evolution
for the
BMW M3 (type E90, E92, E93)

Congratulations on purchasing an Akrapovič exhaust system. Please read these installation instructions carefully. If you have any trouble installing the system, please contact your authorized dealer!

IMPORTANT INFORMATION

Exclusion of Certain Liability

1. The manufacturer, importer or dealer shall not be liable for any incidental damage including personal injury or any other damages caused by improper installation or operation of the Akrapovič exhaust system. When installing the Akrapovič exhaust system be careful that the exhaust system does not touch other parts sensitive to high temperature.
2. Akrapovič makes no representation or warranties with regard to damage caused by the improper installation, use and maintenance of the Akrapovič exhaust system. The warranty is limited to defects recognized by our technical department and due to normal use, and excludes items subject to normal wear (gaskets and damping wool). The guarantee is void in case of accident, modification, improper or competition use.
3. Do not attempt to install the Akrapovič exhaust system on a vehicle model for which it was not made or tested by Akrapovič.
4. When the exhaust system gets very hot during operation, be careful not to burn yourself on the exhaust system or parts which are in direct contact with it, even when the engine is not running. Also protect other people, especially children, from the injuries mentioned above.
5. In some cases Akrapovič exhaust system kits contain chemical products (ceramic anti-seizing grease; bolt sealant). Handle with care, do not inhale or swallow. Avoid excessive contact with skin, eyes or mucous membranes. Keep out of reach of children.
6. Technical specifications of Akrapovič exhaust systems and related products are subject to change without notice.

Trademarks

The Akrapovič Exhaust System Technology logo is a registered trademark of Akrapovič d.d.

Akrapovič website

Information about Akrapovič exhaust systems and related products is available on the Akrapovič website at:

<http://www.akrapovic.com/>

Copyright

No part of the Akrapovič exhaust system or its documentation may be reproduced or distributed in any form or by any means without the prior written authorization of the Akrapovič company.

© Akrapovič, d.d. All rights reserved.

Symbols

The following symbols are used throughout these installation instructions:



TOOLS REQUIRED



TIGHTENING TORQUE



INSTALLATION TIP



CAUTION OR WARNING



USE BOLT SEALANT; Apply 3 to 4 small drops of bolt sealant onto the cleaned and degreased threads before tightening the bolts. **WARNING! Avoid contact with skin, eyes and mucous membranes. Do not inhale fumes. Keep out of the reach of children.**



USE ANTI-SEIZE LEAD-FREE COPPER PASTE (black tube); Provides trouble-free and long-lasting protection against seizing, corrosion and rusting of bolts, threaded ends, nuts, joints, etc. Also protects against vibration, wear and impact. **WARNING! Avoid eye contact. Avoid excessive skin contact. Keep out of reach of children.**



USE ANTI-SEIZING GREASE (white tube); Prevents seizing, corrosion and excessive wear between the titanium components of your exhaust system. **WARNING! Avoid eye contact. Avoid excessive skin contact. Keep out of reach of children.**



T-handle swiveling CTX E12 wrench
T-handle swiveling 13 mm wrench
Combination 13 mm wrench
Combination 22 mm wrench



BEFORE INSTALLING, CHECK THE SCHEMATIC OF THE EXHAUST SYSTEM!



IF ANY ITEMS IN THE AKRAPOVIČ EXHAUST SYSTEM PACKAGE ARE MISSING, PLEASE CONTACT YOUR AUTHORIZED DEALER. KEEP THE SCHEMATIC FOR FUTURE REFERENCE.



THESE INSTALLATION INSTRUCTIONS MUST BE READ CAREFULLY IN ORDER TO ENSURE PROPER INSTALLATION AND OPERATION OF THE AKRAPOVIČ EXHAUST SYSTEM.



THE EXHAUST SYSTEM CAN BE EXTREMELY HOT. ALLOW THE EXHAUST AND ENGINE TO COOL DOWN BEFORE BEGINNING INSTALLATION.



WE ADVISE YOU TO LEAVE INSTALLATION TO A QUALIFIED SERVICEMAN. IMPROPER INSTALLATION MAY RESULT IN A SHORTER LIFETIME OF THE EXHAUST SYSTEM AND/OR DAMAGE TO THE VEHICLE.

REMOVAL OF STOCK EXHAUST SYSTEM (SLIP-ON AND EVOLUTION):

Put the vehicle onto a car lift.

! **WARNING:** make sure, that car lifting is safely and correctly done or you risk vehicle damage, injury or even death!

1. **For Slip-On and Evolution:** unscrew the M8 nuts from stock muffler rubber brackets on both sides of the vehicle (**Figure 1**).

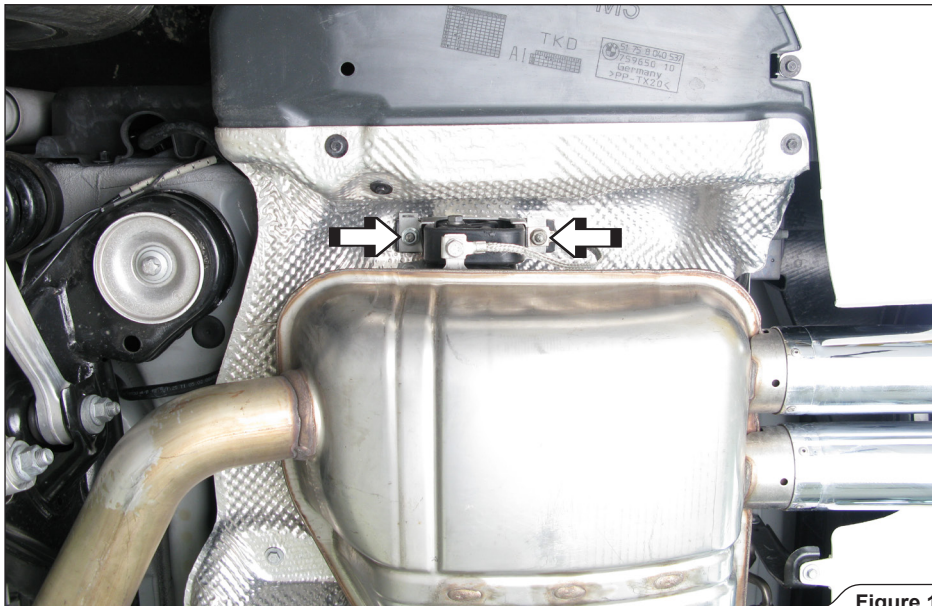

Figure 1

2. For Slip-On and Evolution: unscrew the marked clamps (Figure 2).

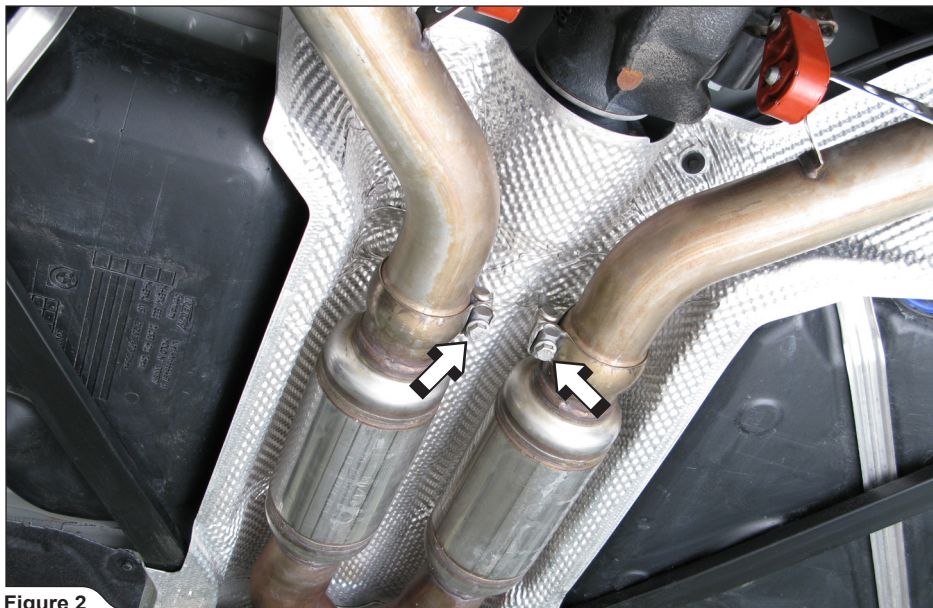

Figure 2

3. **For Slip-On and Evolution:** unhook the marked rubber dampers and remove the stock muffler from the vehicle (**Figure 3**).

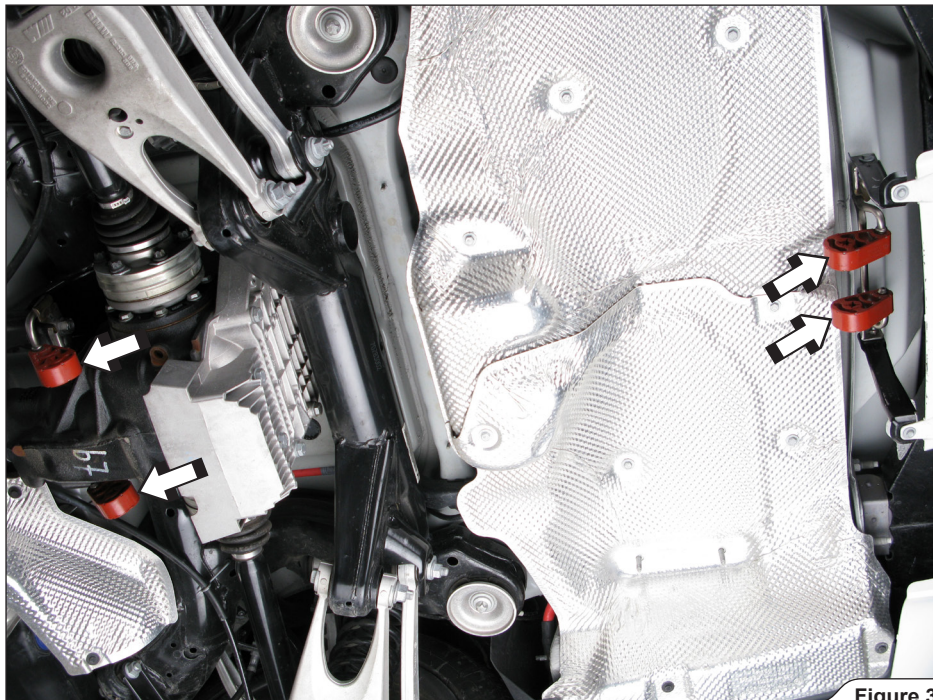

Figure 3

4. **For Evolution:** unscrew the marked bolts and nuts on both sides of the vehicle (**Figure 4**).

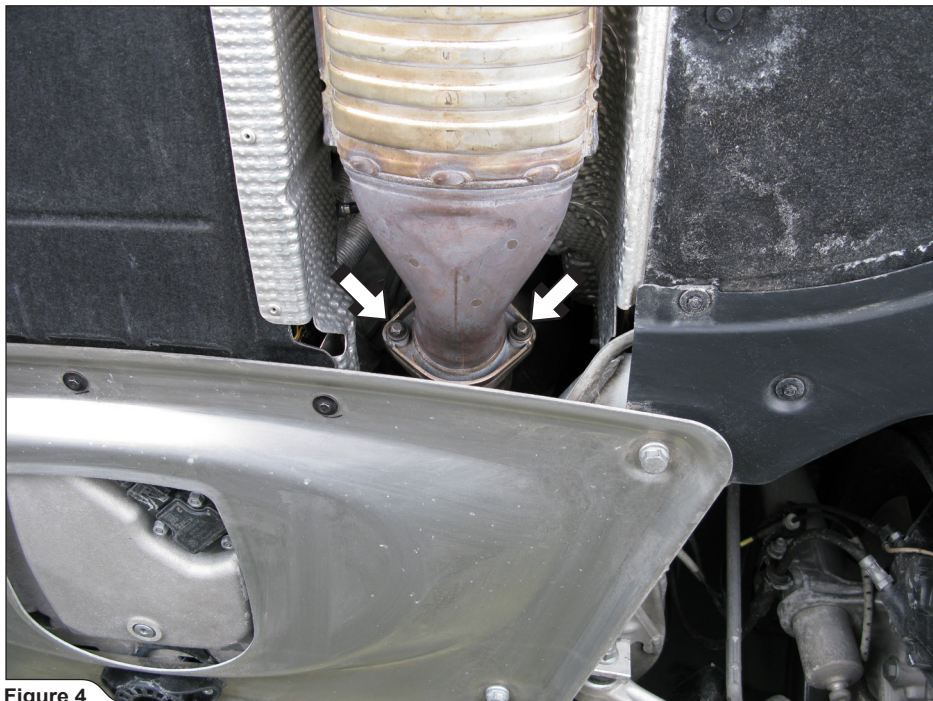

Figure 4

5. **For Evolution:** unscrew the marked middle pipes brackets (**Figure 5**).

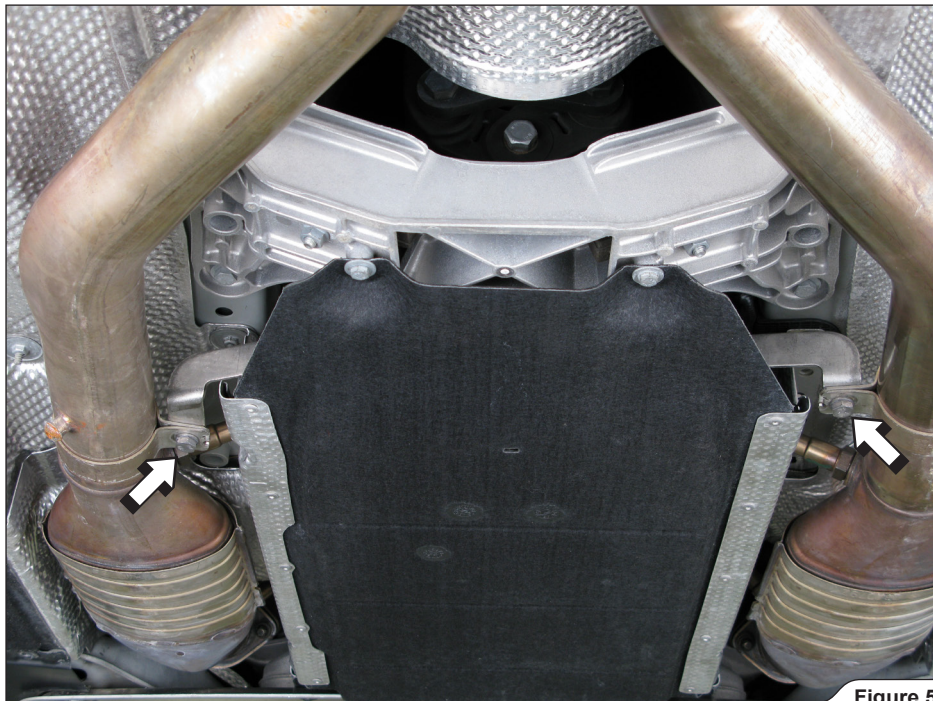

Figure 5

6. **For Evolution:** unscrew all four lambda sensors on both sides of the vehicle (**Figure 6**).
- !** **WARNING:** be careful not to damage the electrical leads of the lambda sensors during this process!

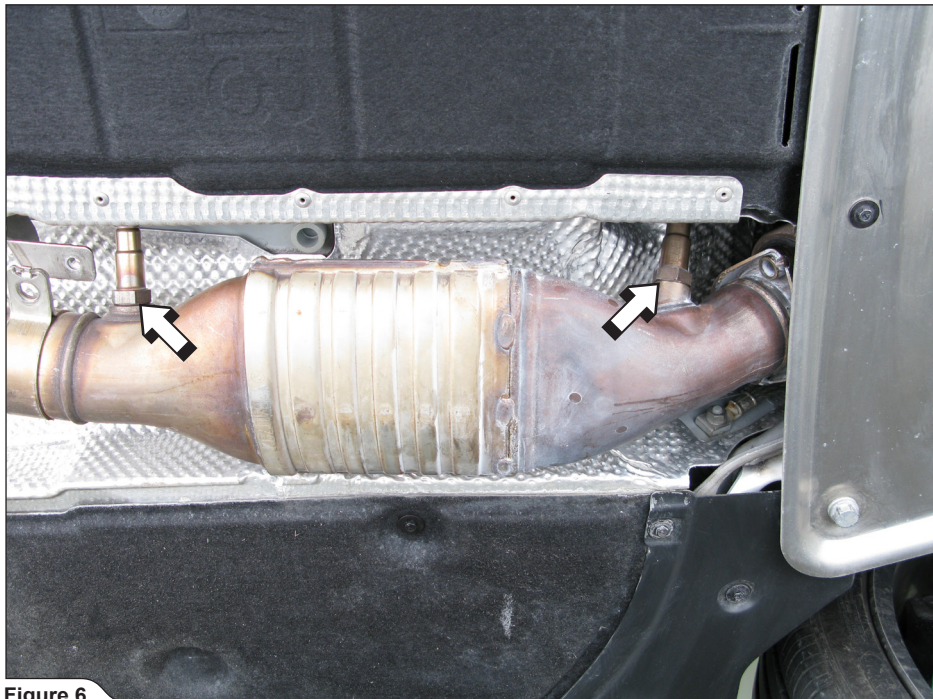

Figure 6

7. **For Evolution:** unscrew the marked bolts and remove stock middle pipes together with bracket (**Figure 7**).

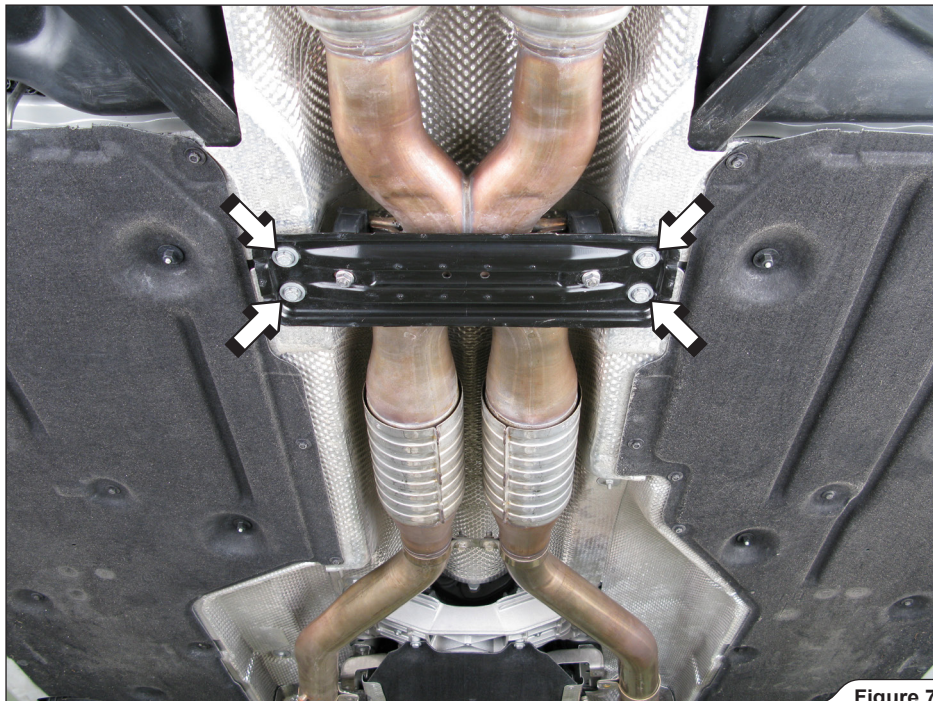

Figure 7

8. **For Evolution:** unscrew the marked nuts and remove the bracket from stock middle pipes (**Figure 8**).



Figure 8

9. For optional Akrapovič delete-R: unscrew the marked bolts and remove the engine hood handle and plastic sill panel (Figure 9).



Figure 9

10. For optional Akrapovič delete-R: unscrew the OBD connector (Figure 10).



Figure 10

INSTALLATION OF THE AKRAPOVIČ EXHAUST SYSTEMS (SLIP-ON AND EVOLUTION):

1. **For Evolution:** set the Akrapovič headers with additional Akrapovič metal clamps (**Figure 11**).

✂ **INSTALLATION TIP:** coat the interior of the inlet bush of the headers' cross connection with ceramic grease (white tube).



Figure 11

2. **For Evolution:** tighten the headers, header's clamps and lambda sensors to a specified torque (Figure 12).

! **CAUTION:** use new exhaust gaskets in Akr. headers - stock collectors joint!

! **WARNING:** use anti-seize copper paste on all bolts and nuts threads!

! **WARNING:** use anti-seize copper paste only on sensors' threads!

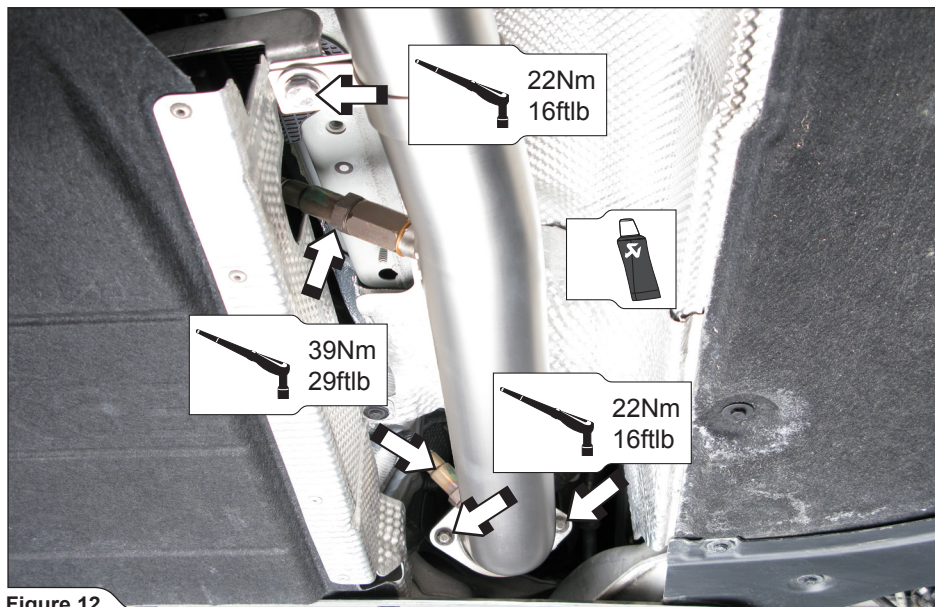

Figure 12

3. **For Evolution:** attach the stock bracket and additional metal clamps to Akrapovič middle pipes (Figure 13).

! **WARNING:** use anti-seize copper paste on nuts threads (especially on both clamp bolts)!
✂ **INSTALLATION TIP:** coat the interior of the inlet bushes of the middle pipes with ceramic grease (white tube).



Figure 13

4. **For Evolution:** slide the middle pipes onto the headers, tighten the stock bracket and clamps to a specified torque (**Figure 14**).

! **WARNING:** use anti-seize copper paste on all bolt threads!

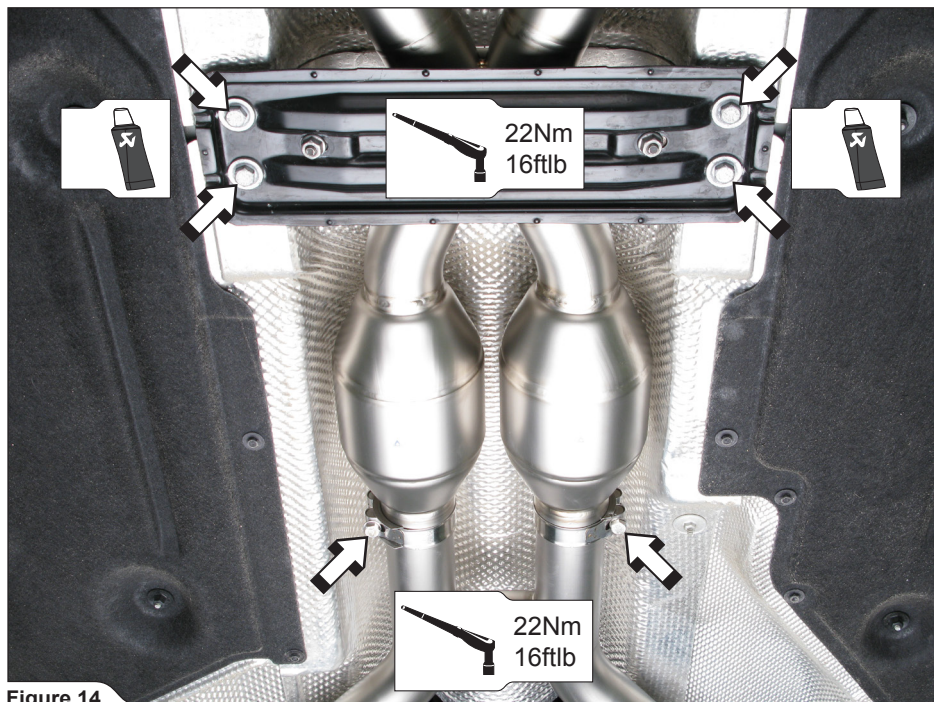

Figure 14

5. **For Slip-On and Evolution:** attach the stock muffler brackets (bear in mind, that brackets are not simetrical) and ground wires on both Akrapovič mufflers (**Figure 15**).

! **WARNING:** use anti-seize copper paste on all bolt threads!

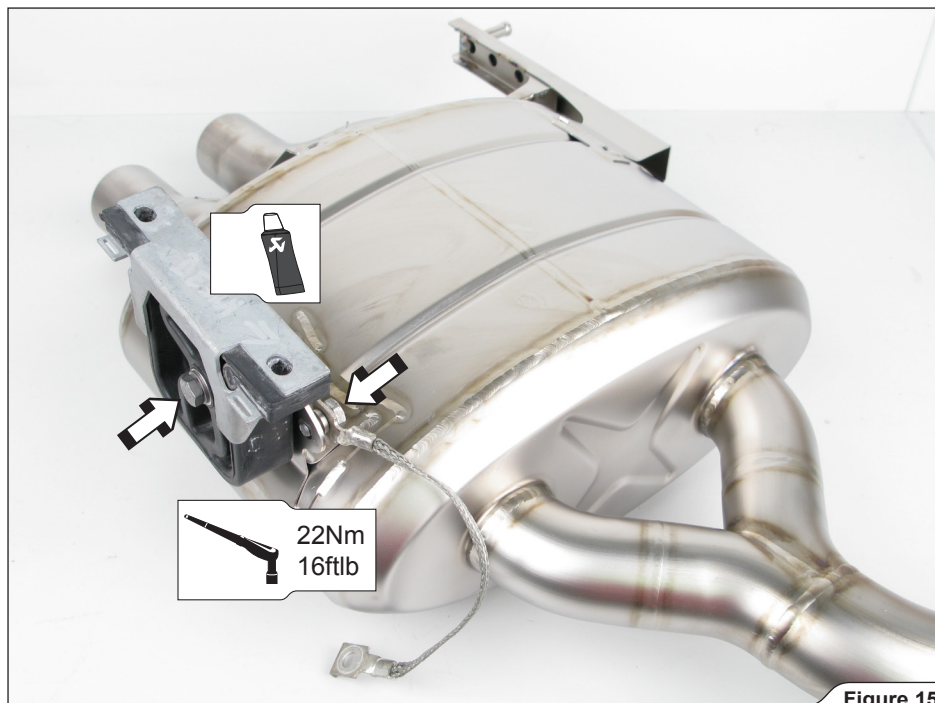

Figure 15

6. **For Evolution:** attach additional metal clamps to Akrapovič muffler pipes (**Figure 16**).

! **WARNING:** use anti-seize copper paste on both clamp bolt threads!

✂ **INSTALLATION TIP:** coat the interior of the inlet bushes of the muffler pipes with ceramic grease (white tube).



Figure 16

7. **For Slip-On:** attach additional metal clamps and tube adapters to Akrapovič muffler pipes (Figure 17).

! **WARNING:** use anti-seize copper paste on both clamp bolt threads!

- ✂** **INSTALLATION TIP:** coat the interior of the inlet bushes of the muffler pipes with ceramic grease (white tube), before adapter insert.



Figure 17

8. **For Slip-On and Evolution:** slide both Akrapovič mufflers onto the middle pipes and hang them onto marked stock rubber brackets (**Figure 18**).

! **WARNING:** use anti-seize copper paste on all bolt and nut threads!

✂ **INSTALLATION TIP:** for easier mounting, lubricate the stock rubber brackets.

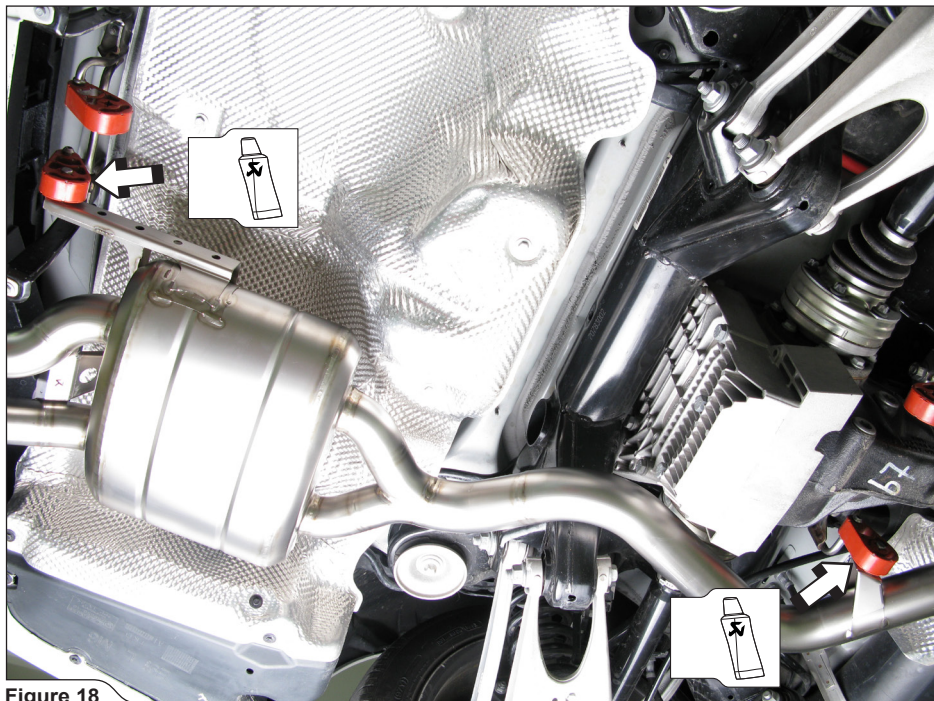

Figure 18

9. **For Slip-On and Evolution:** tighten the stock muffler brackets and ground wires to the vehicle chassis (Figure 19).

! **WARNING:** use anti-seize copper paste on all nut threads!

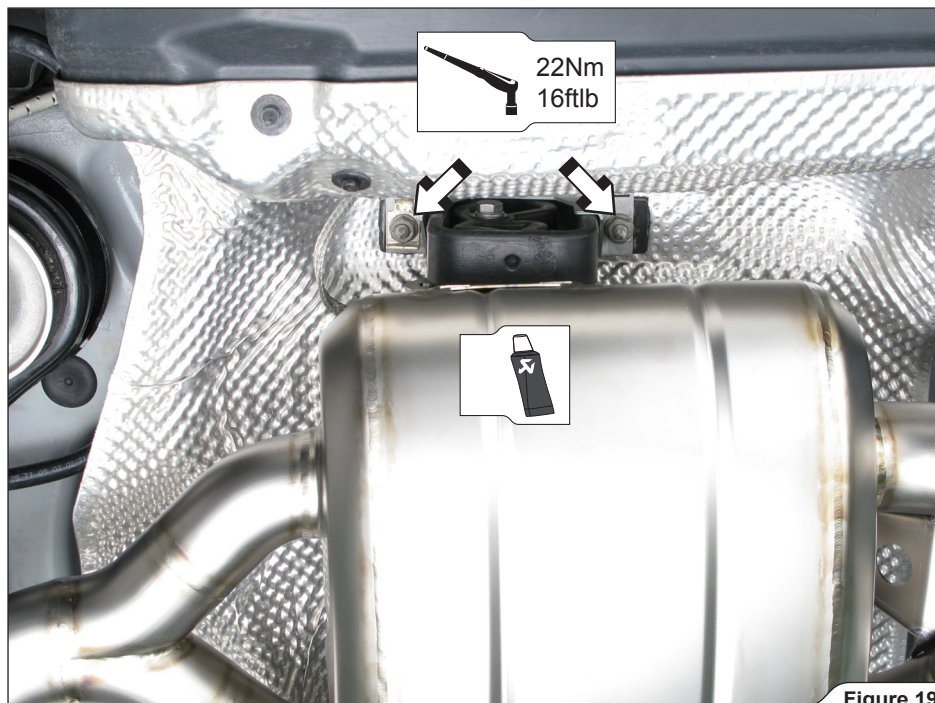

Figure 19

10. **For Evolution:** tighten the metal clamps on middle pipes-muffler pipes connections to a specified torque (**Figure 20**).

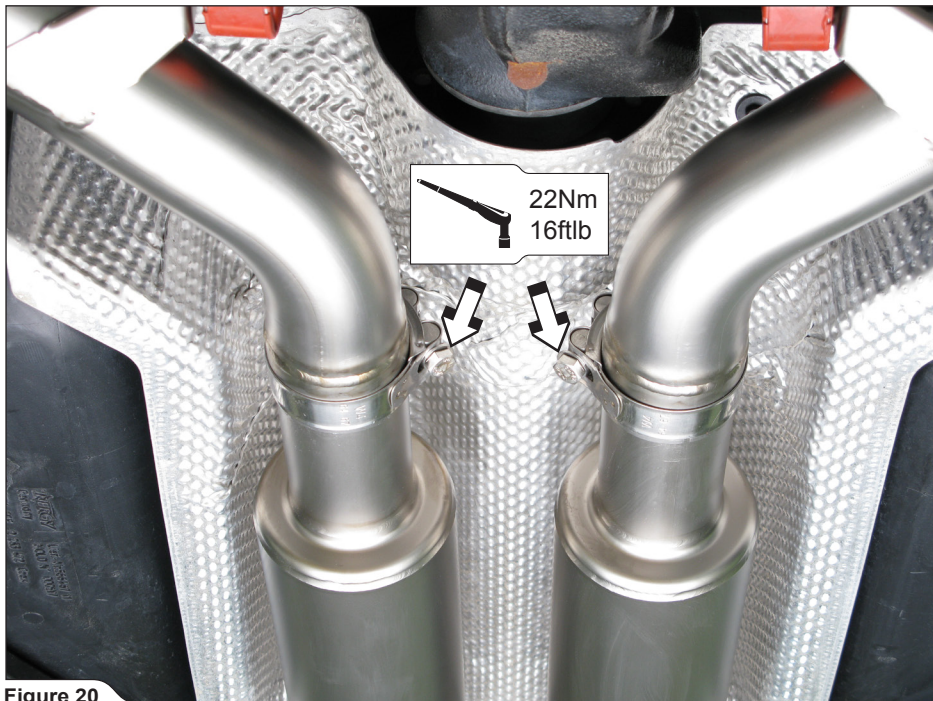

Figure 20

11. **For Slip-On:** tighten the Akrapovič and stock metal clamps on middle pipes-muffler pipes connections to a specified torque (**Figure 21**).

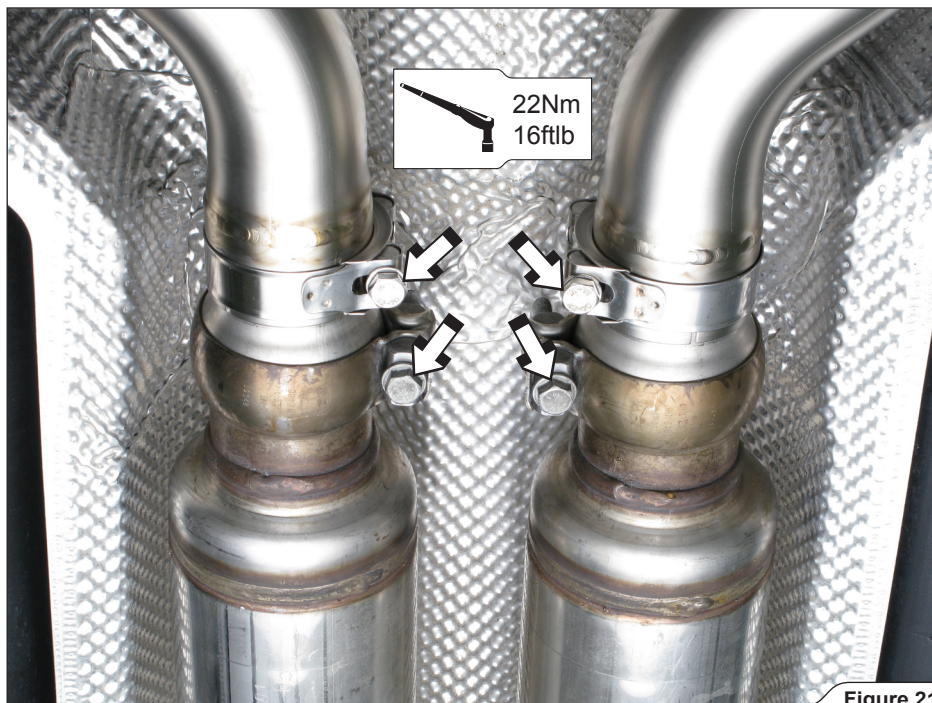

Figure 21

12. **For Slip-On and Evolution:** slide and center the Akrapovič tail-pipes (in respect to rear bumper) onto the mufflers' outlet pipes as shown on both sides of the vehicle (**Figure 22**).

✘ INSTALLATION TIP: coat the interior of the inlet bushes of the tail pipes with ceramic grease (white tube).

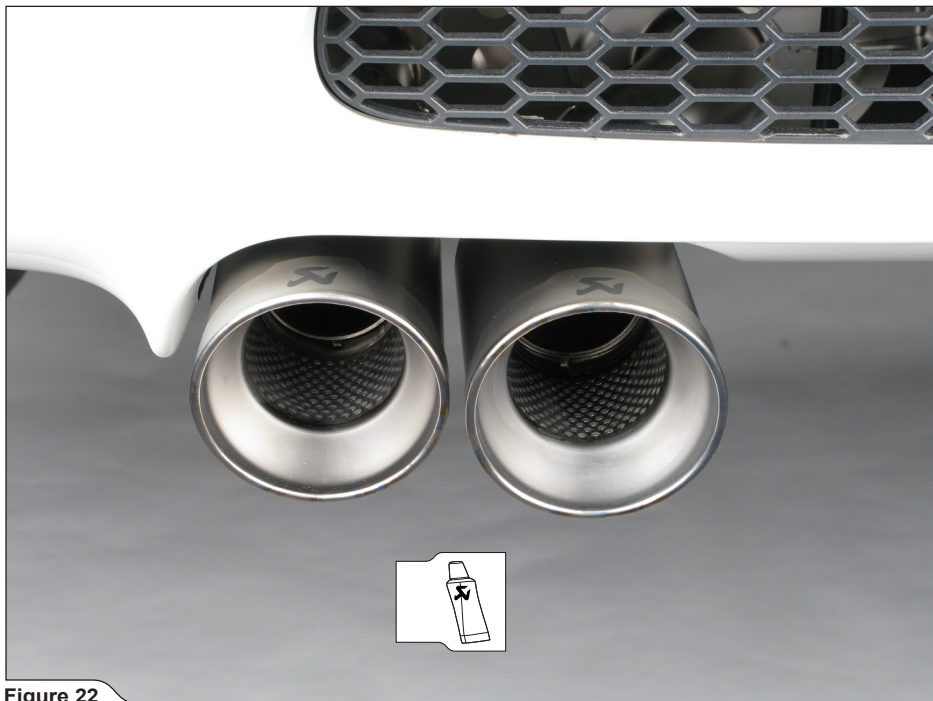

Figure 22

13. **For Slip-On and Evolution:** tighten the marked bolts to a specified torque on both sides of the vehicle (**Figure 23**).

! **WARNING:** use anti-seize copper paste on all nut threads!



Figure 23

14. For optional Akrapovič delete-R: plug the Akrapovič delete-R's OBD blue connector with stock black OBD connector (Figure 24).

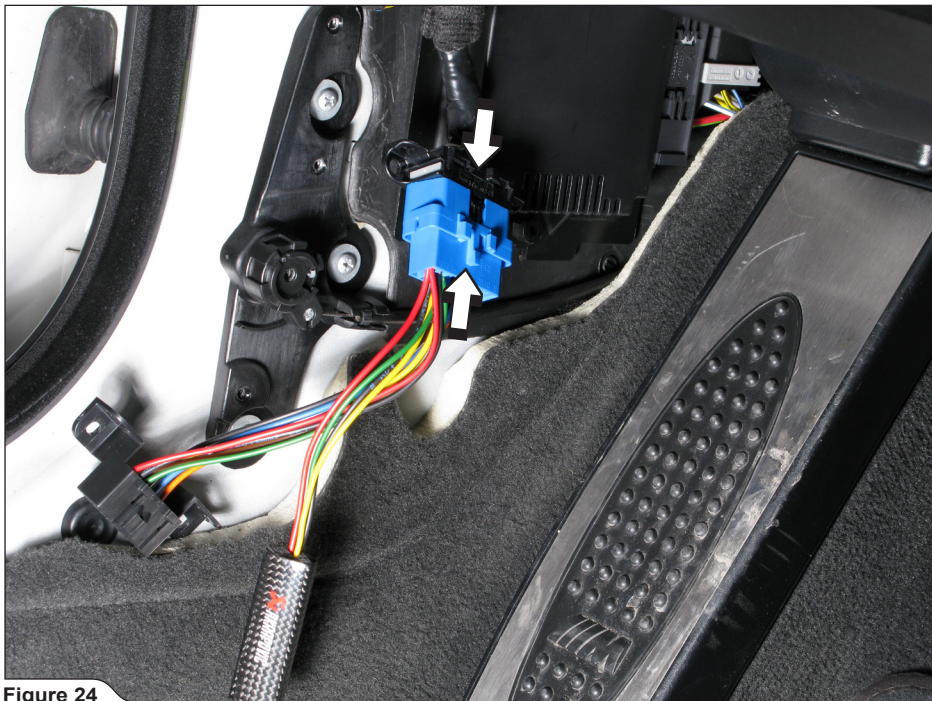

Figure 24

15. For optional Akrapovič delete-R: tuck in the OBD connectors, as shown (Figure 25).

! CAUTION: make sure not to damage any part of the delete-R or vehicle during this process!



Figure 25

16. **For optional Akrapovič delete-R:** attach the Akrapovič OBD connector and fix the Akrapovič delete-R as shown, using the plastic tie wrap (Figure 26). Replace the plastic sill panel and engine hood handle in the reverse order from the order in which they were removed.

! **WARNING:** after the delete-R is installed, please start the engine and leave the car running at idle for 10 minutes. If the emission light was ON before installation, it will go OFF after that period!

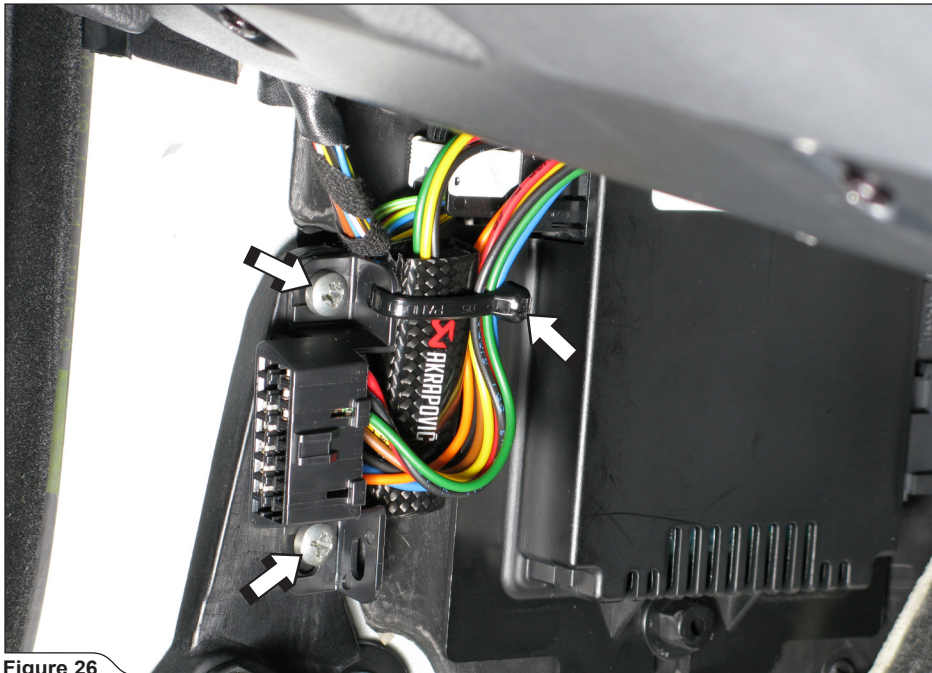

Figure 26

Final installation:

- ! WARNING: check vehicle manufacturer manual for tightening torques (for dismantled stock parts)!**
- ! WARNING: make sure all the nuts and bolts are sufficiently tightened. In case the exhaust system touches the cowling or other parts, repeat the adjustment of the exhaust system or contact your authorized dealer.**

OPTIONAL AKRAPOVIČ DELETE-R PURPOSE AND OPERATION:

This device will eliminate eventual error codes possibly caused by the high flow catalyts used in the Akrapovic Evolution exhaust system.

MAINTENANCE OF THE AKRAPOVIČ EXHAUST SYSTEM:

1. Clean the titanium exhaust components with a multi-purpose spray lubricant (WD-40 or equivalent), carbon fiber exhaust components with soft and dry cloth and stainless steel components with soft cloth sprayed with contact cleaner, then wipe with soft and dry cloth. A change in the color of the exhaust system is normal due to high temperatures.
2. Periodically make sure all the bolts and springs are sufficiently tight.

! WARNING: clean all exhaust components before the first start of the engine or the stains will burn onto the surfaces!

! IT IS NORMAL IF WHITE SMOKE COMES OUT OF THE MUFFLER ON FIRST OPERATION.

! DO NOT STAND BEHIND THE MUFFLER ON FIRST OPERATION.

! DO NOT USE AUTOMOTIVE WHEEL CLEANERS OR ANY CLEANING PRODUCTS WHICH CONTAIN ACIDIC ADDITIVES TO CLEAN AKRAPOVIČ EXHAUST SYSTEMS.

BMW M3 E90 Slip-on exhaust system / EC Type approval

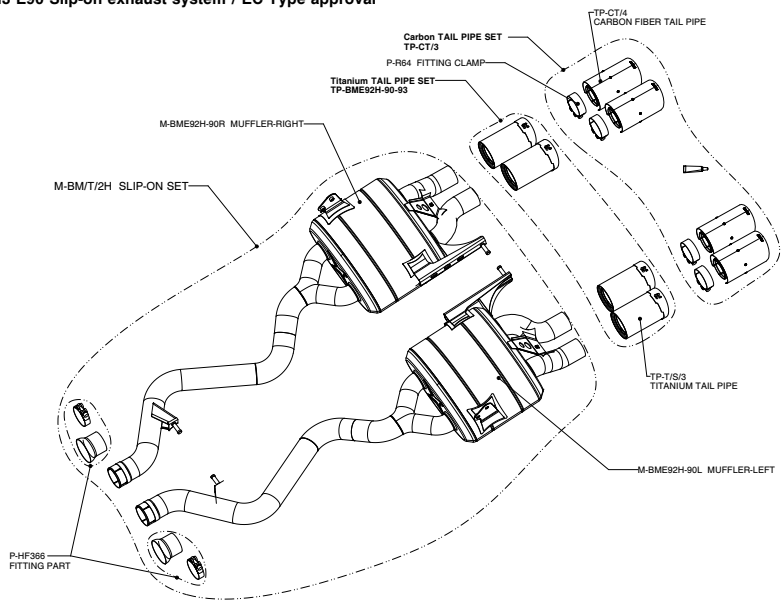

BMW M3 E90 Evolution exhaust system

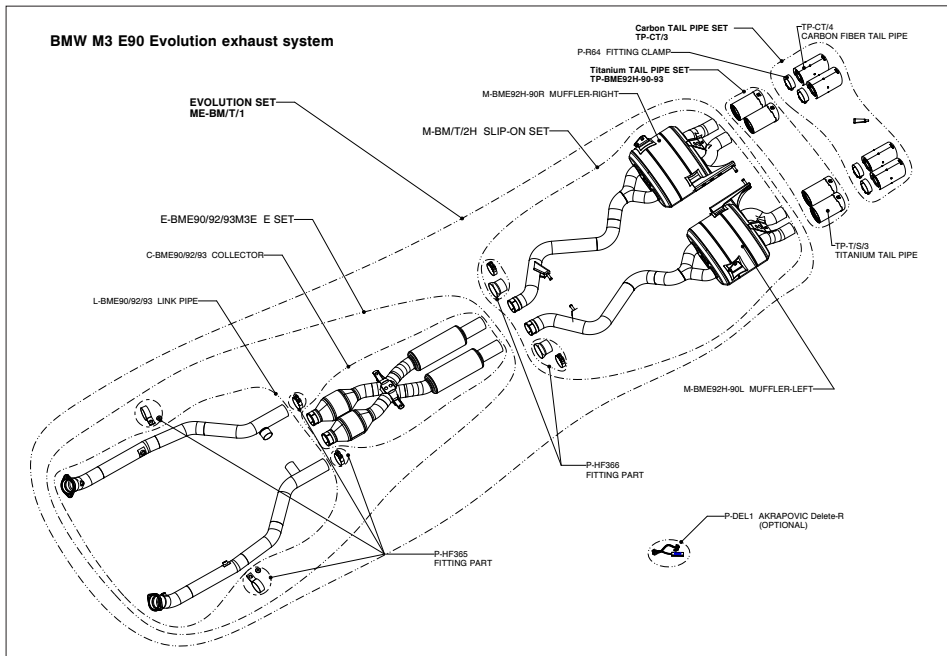

BMW M3 E92/E93 Slip-on exhaust system / EC Type approval

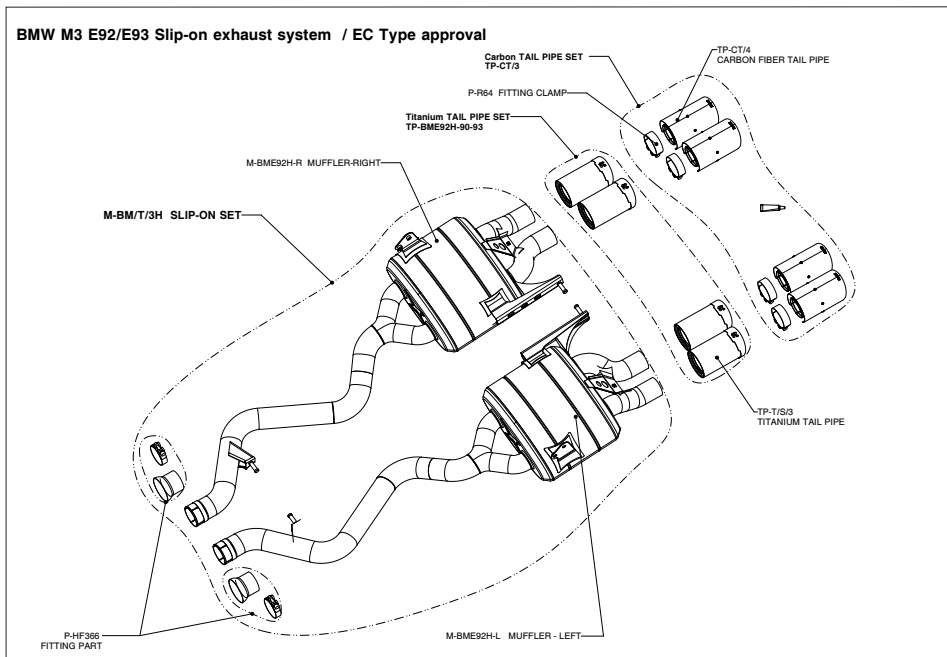

BMW M3 E92/E93 Evolution exhaust system

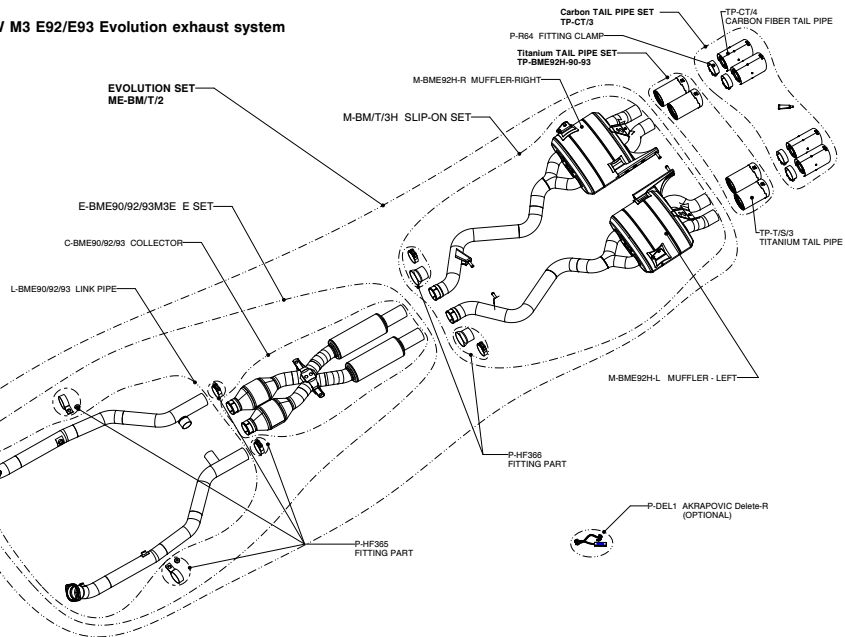

www.akrapovic.com



502256