

advanced FLOW engineering Momentum GT Cold Air Intake System

Instruction Manual P/N: 50-70061D / 50-70061R

Make: BMW	Model: 330i (G20)	Year: 2019-2021	Engine: L4-2.0L (t) B48
Make: BMW	Model: 330ix (G20)	Year: 2019-2021	Engine: L4-2.0L (t) B48
Make: BMW	Model: 430i (G22/G23)	Year: 2021-2021	Engine: L4-2.0L (t) B48
Make: BMW	Model: 430ix (G22/G23)	Year: 2021-2021	Engine: L4-2.0L (t) B48



- Please read the entire instruction manual before proceeding.
- Ensure all components listed are present.
- For technical support please call at 951-493-7185.
- Ensure you have all necessary tools before proceeding.
- Do not attempt to work on your vehicle when the engine is hot.
- Retain factory parts for future use.

Label	Qty.	Description	Part Number
A1	1	Air Filter (Pro DRY S)	21-91113
A2	1	Air Filter (Pro 5R)	24-91113
B	1	Tube	05-5070061B1
C	1	Housing	05-5070060B2
D	1	Coupling, Silicone Bellow	05-01557
E	2	Clamp, #044	03-50019
F	1	Fitting, Aluminum: ¼-NPT	03-50644
G	1	Fitting, Aluminum (CCV): 50-70061R	05-01559
H	1	Auxiliary Plug	05-01482
I	2	Screw, M4	03-50490
J	1	Grommet	03-50139

Installation will require the following tools:

6mm and 8mm nut drivers or sockets, 13mm socket, socket wrench, flat-head screwdriver, T20 torx bit, and panel popper.

Emissions Disclaimer:

This product is not currently CARB exempt and is not available for purchase in California or for use on any vehicle registered with the California Department of Motor Vehicles.

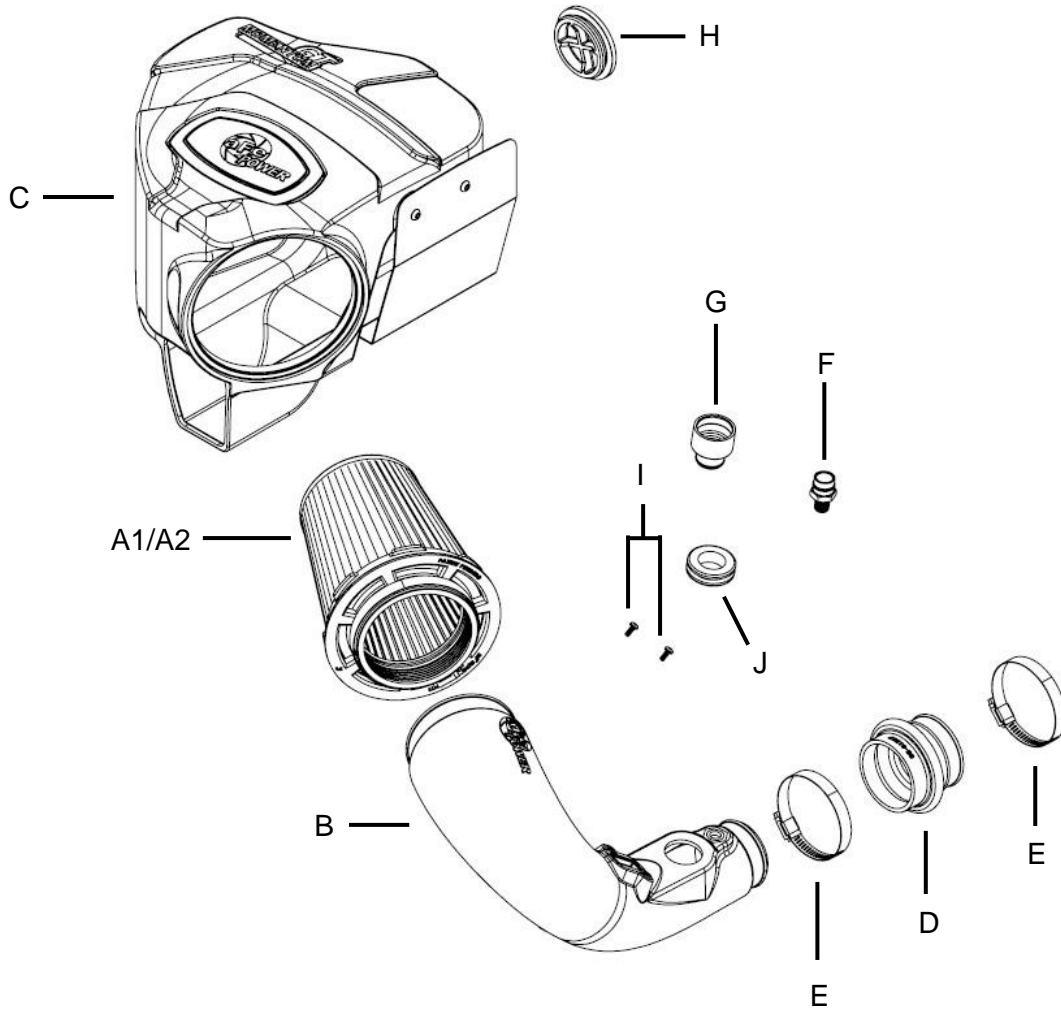

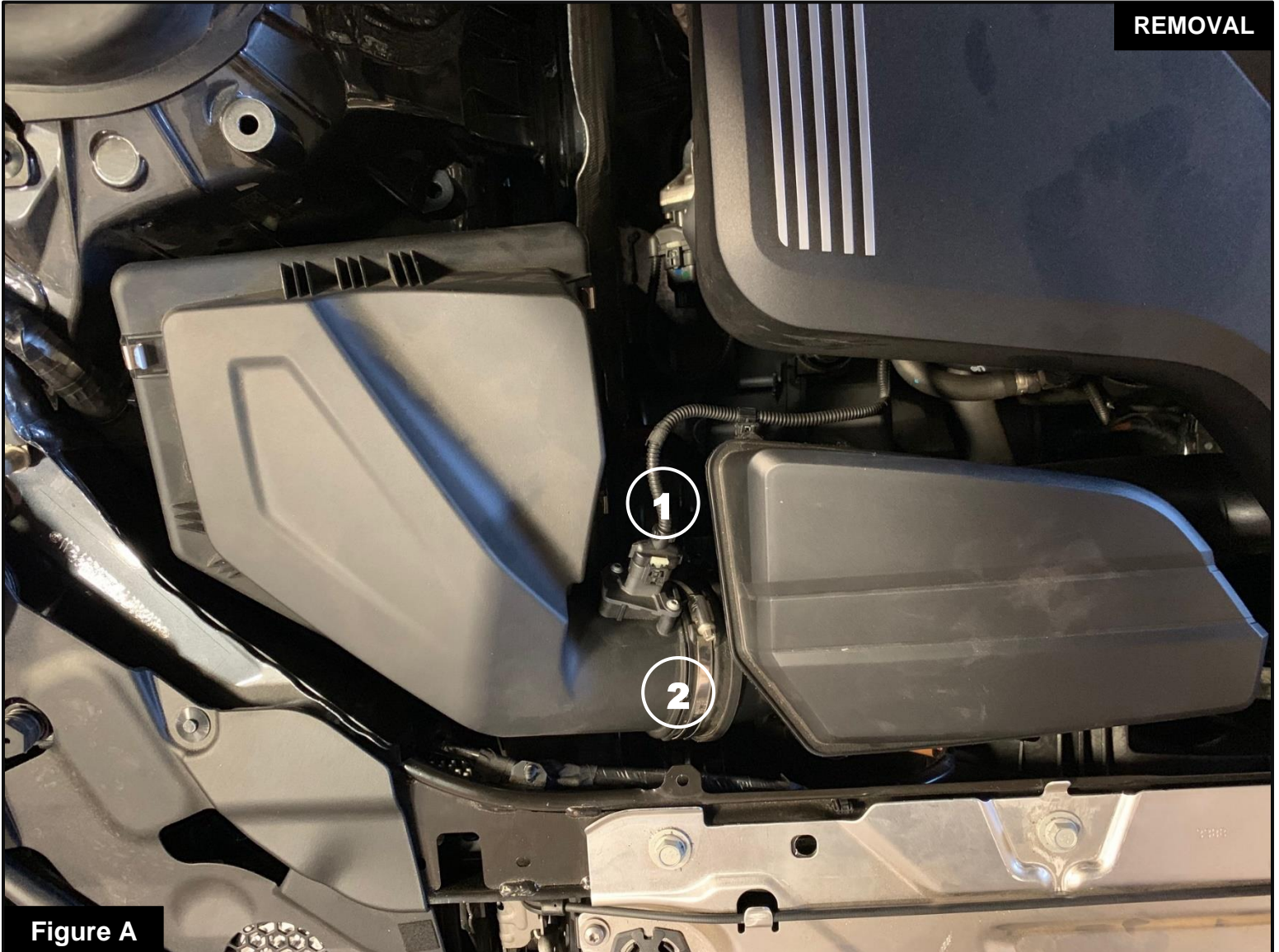
**Figure A****Refer to Figure A for Steps 1-4**

Step 1: If the vehicle is equipped with a brace above the factory intake, remove the brace.

NOTE: This aFe POWER intake is design to fit with and without the factory brace.

Step 2: Gently disconnect the MAF sensor harness (1).

Step 3: Using a 6mm nut driver, loosen the hose clamp at the factory airbox (2). Then, slide the factory intake tube away from the factory airbox.

Step 4: To remove the factory airbox, carefully pull up on the factory airbox.

**Figure B****Refer to Figure B for Step 5**

Step 5: Detach the harness hooks from the two (2) locations on the factory intake tube (3).

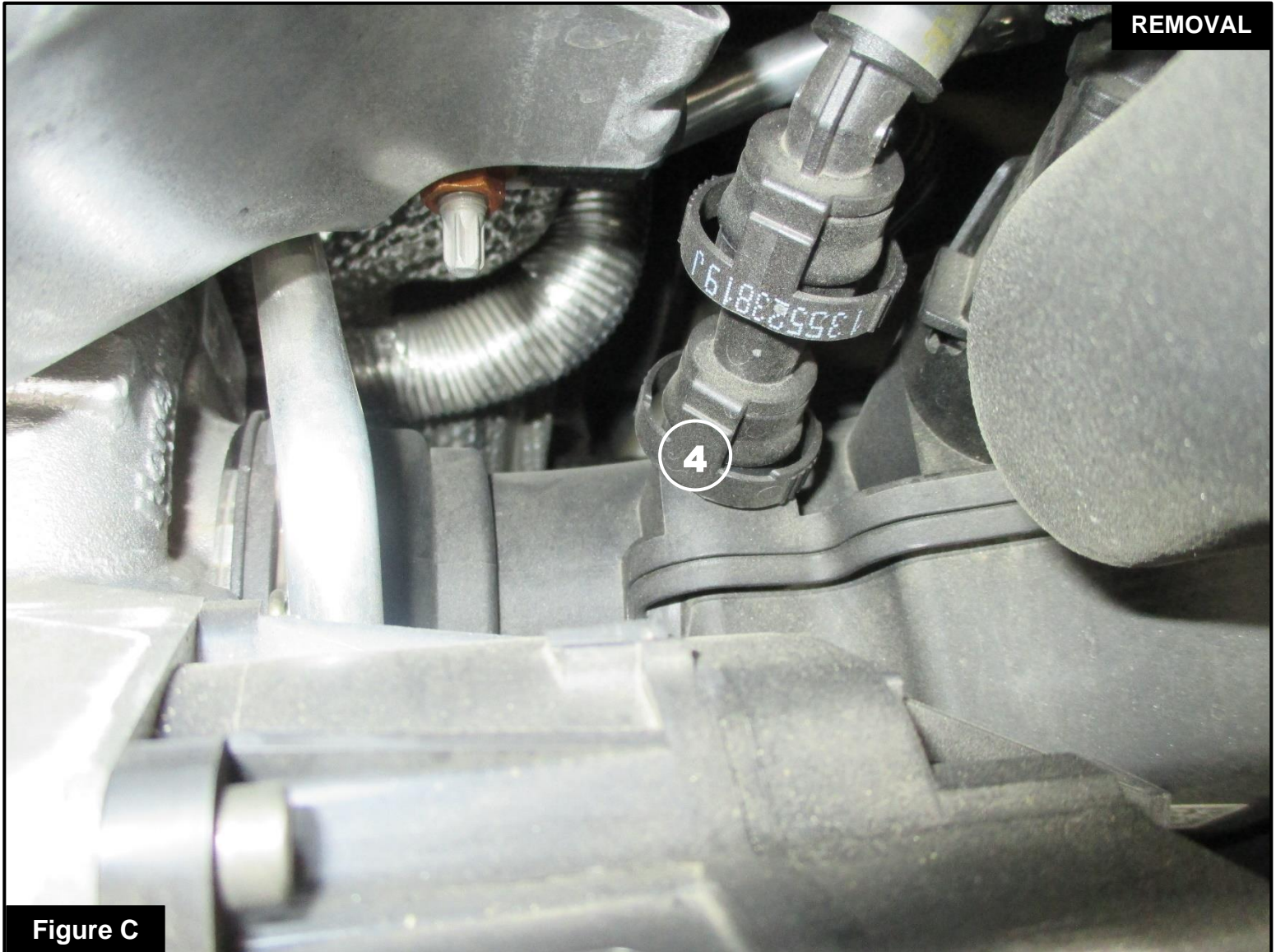

Refer to Figure C for Step 6

Step 6: Disconnect the bottom half of the crankcase ventilation (CCV) line (4) from the factory intake tube.
Do not disconnect the top half of the CCV line.

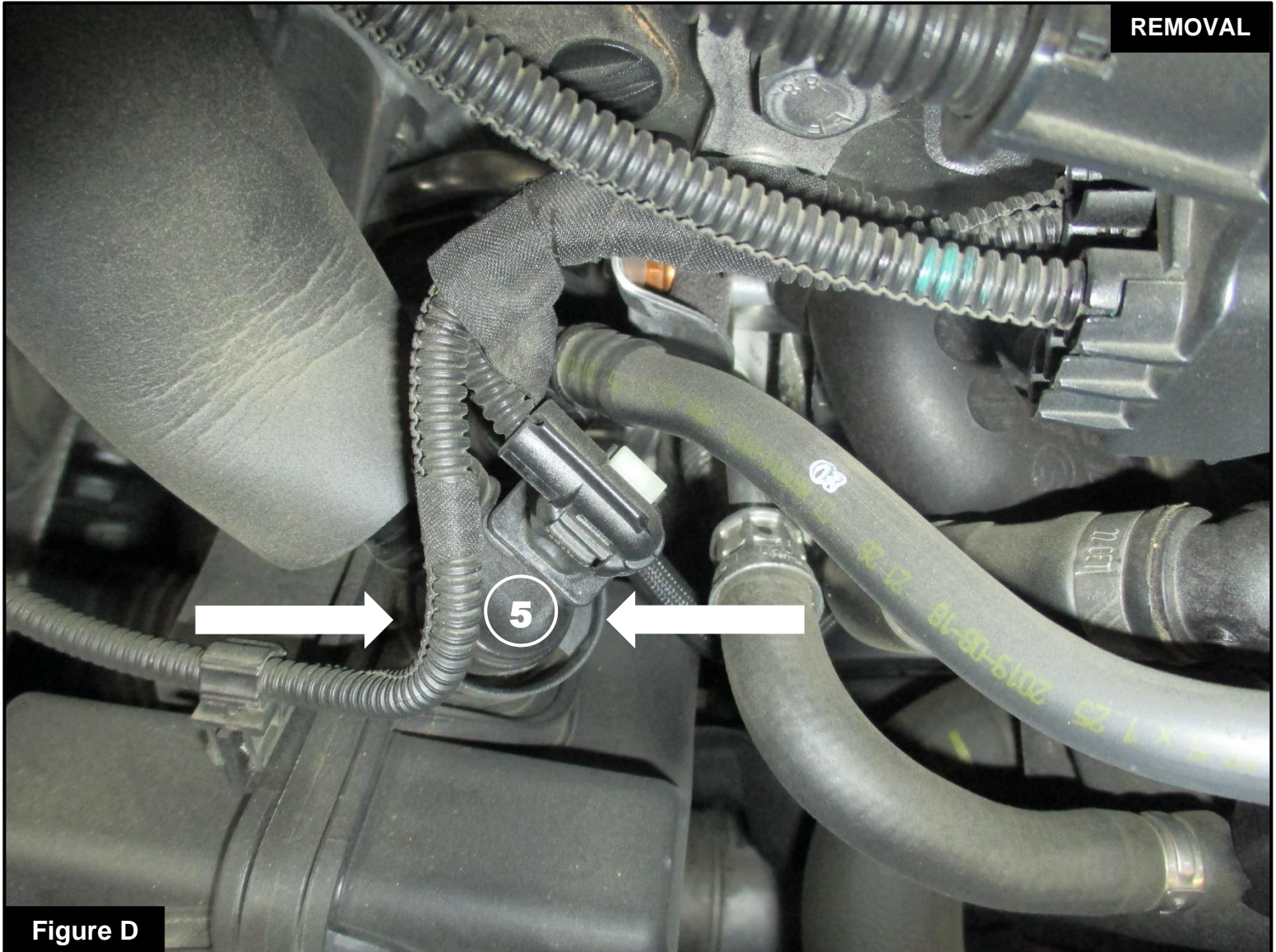
**Figure D****Refer to Figure D for Step 7**

Step 7: Carefully remove the larger CCV line. Press the two opposite facing tabs in and carefully lift the fitting from its port ⑤.

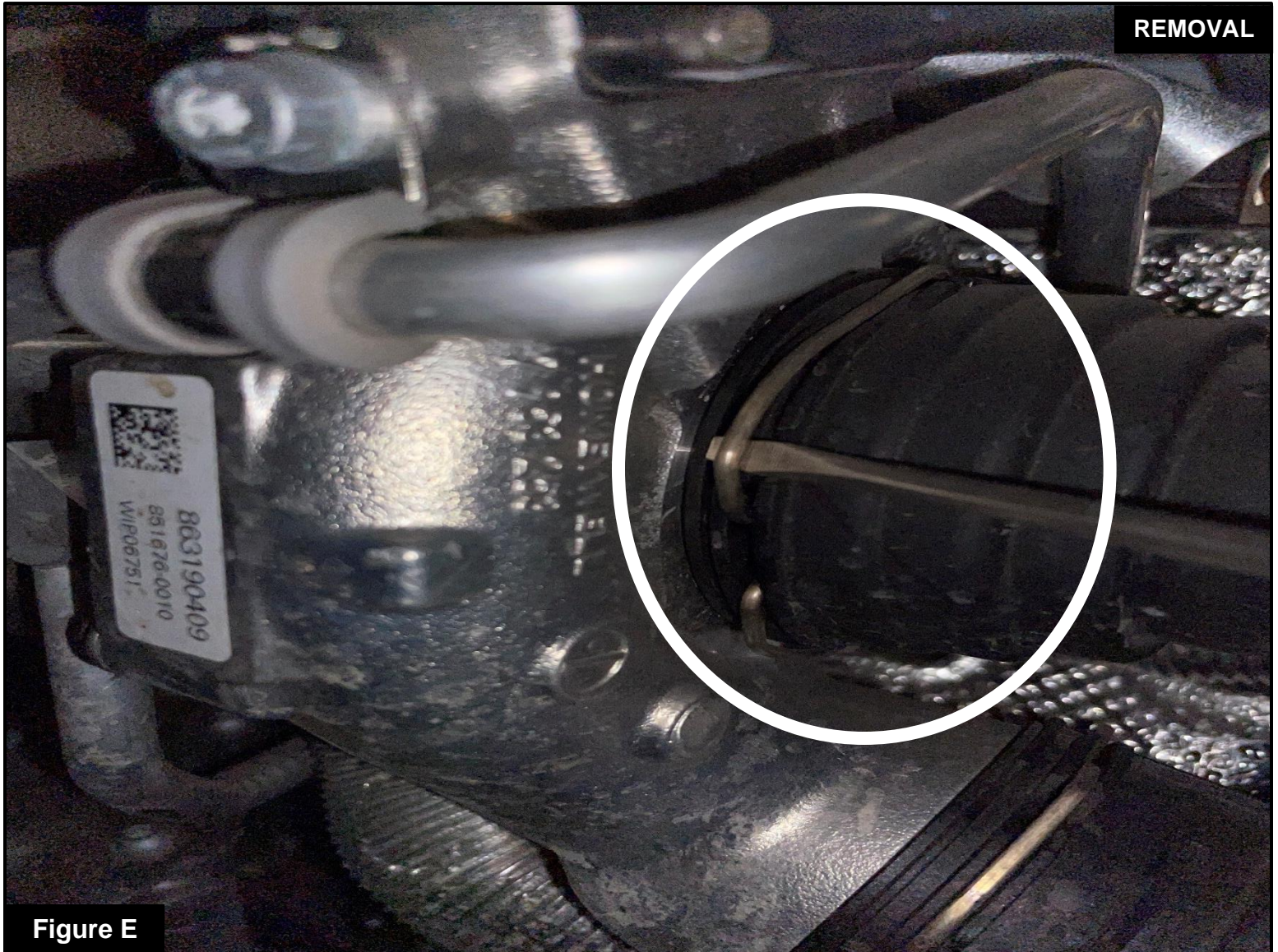

Refer to Figure E for Step 8

Step 8: Remove the retention clip securing the factory intake tube to the turbo ⑥, then carefully pull the factory intake tube from the vehicle.



Figure F

Refer to Figure F for Steps 9-11

Step 9: Transfer the MAF sensor from the factory airbox to the aFe POWER intake tube (7) and attach with the supplied screws.

Step 10: Install the smaller CCV fitting into the NPT insert on the aFe POWER intake tube (8).

NOTE: This is an NPT fitting. The small gap between the tube and hex is normal.

Step 11: Install the larger CCV fitting and supplied grommet into the aFe POWER intake tube (9).

**Figure G****Refer to Figure G for Step 12**

Step 12: Install the air filter into the aFe POWER housing by firmly pushing it into the housing until the air filter tabs lock into place. Install the clamp over the air filter flange, but do not tighten at this time ⑩.

**Figure H****Refer to Figure H for Step 13**

Step 13: This kit includes an optional plug to close off the rear auxiliary air inlet. Install the plug if you wish to close it off, to only capture cold air from the front (11).

NOTE: Without the plug installed, the aFe POWER intake will capture the maximum air available. More airflow offers more power. Some of this air is picked up from inside the engine compartment and could be warmer air. Warmer air will affect the performance of the vehicle.

The plug installed on the housing will block off any hot engine air entering the housing to make sure the coolest air available is directed into the engine. The plug will also reduce the noise of the intake.

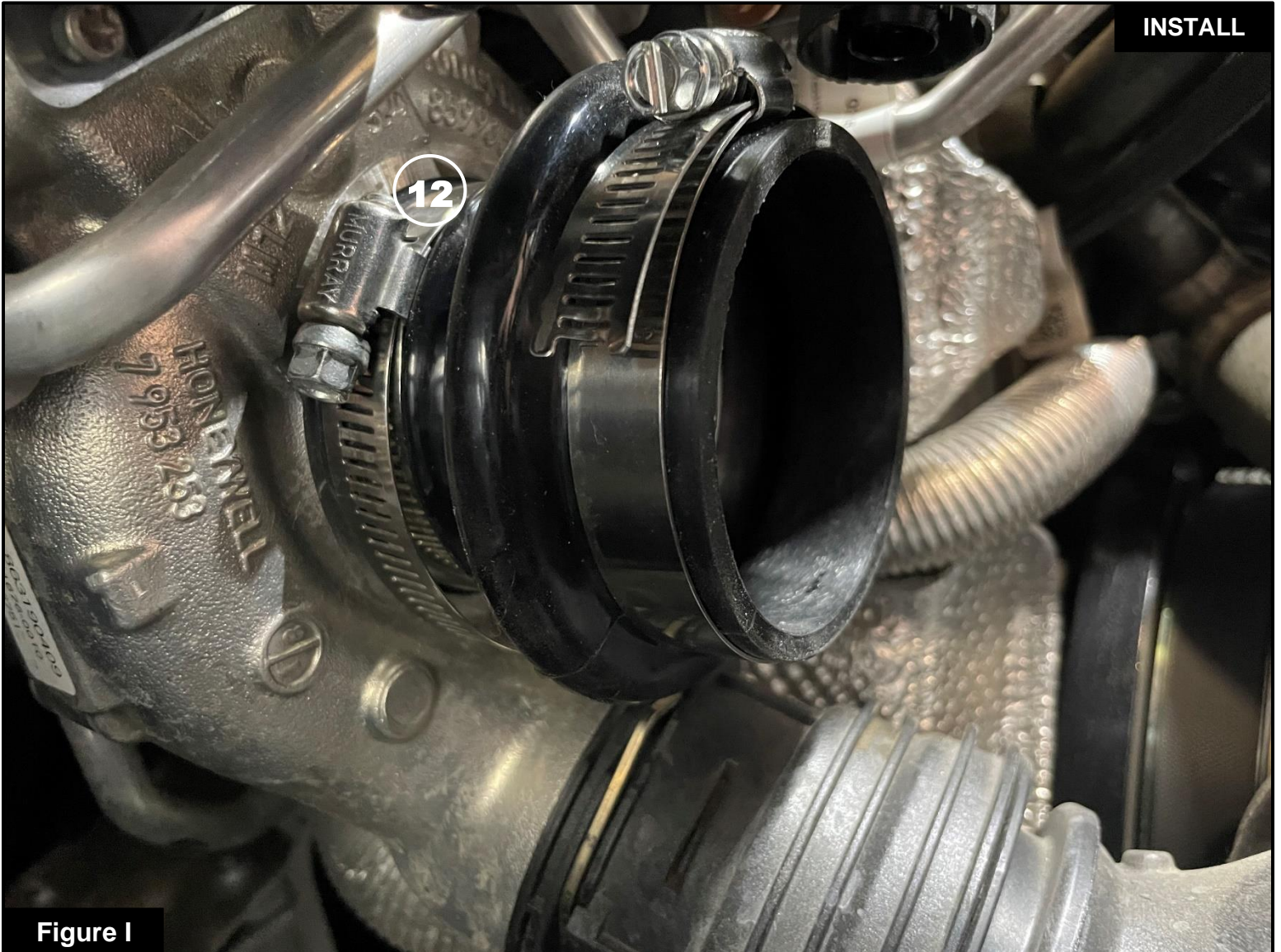
**Figure I****Refer to Figure I for Steps 14-16**

Step 14: Install the supplied coupling onto the turbo inlet and place the supplied clamps onto the coupling.

Step 15: Make sure to have the end of the coupling sit flush to the rim of the turbo inlet. This is to make sure the interior bead of the coupling sits correctly in the groove of the turbo inlet (12).

Step 16: When the coupling sits comfortably on the turbo inlet, tighten the clamp sitting over the coupling and the turbo inlet. Do not tighten the clamp at the open end of the coupling.

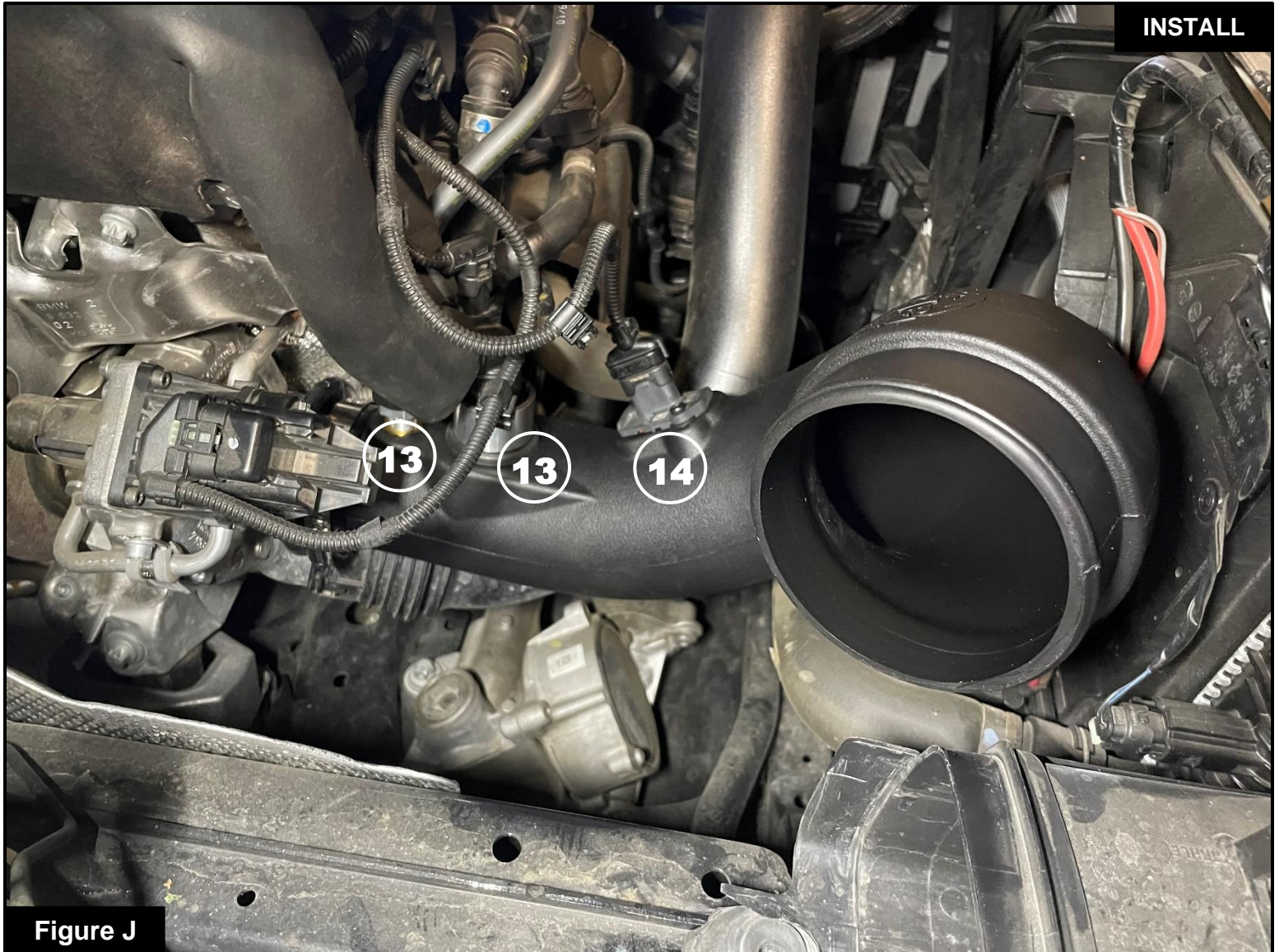

Figure J

Refer to Figure J for Steps 17-19

Step 17: Install the aFe POWER intake tube into the coupling. Do not tighten the clamp at this time.

Step 18: Connect both CCV fittings on the aFe POWER intake tube to the factory lines (13).

Step 19: Connect the MAF sensor to the sensor harness (14).



Figure K

Refer to Figure K for Steps 20-24

Step 20: Install the assembled aFe POWER housing and air filter into the engine bay by pressing down firmly into the three (3) factory mounting grommets.

Step 21: Slip the aFe POWER intake tube into the air filter and tighten the clamp.

Step 22: Tighten the clamp between the aFe POWER intake tube and the coupling.

Step 23: If the vehicle is equipped with a brace, re-install the brace from **Step 1**.

Step 24: Make sure all components and connections are secure. Your installation is now complete. Thank you for choosing aFe POWER!



Page left blank intentionally.



Page left blank intentionally.



Page left blank intentionally.



Pro DRY S Air Filter



P/N: 21-91113

Pro 5R Air Filter



P/N: 24-91113

Pre-Filter



P/N: 28-10113

Pro DRY S Restore Kit



P/N: 90-59999

Pro 5R Restore Kit



P/N: 90-50501

SPRINT BOOSTER V3



P/N: 77-16302

Scorcher GT Power Module



P/N: 77-46318

Scorcher GT Power Module



P/N: 77-86318

Flashlight



P/N: 40-10202

Bluetooth Speaker



P/N: 40-10232

Power Bank



P/N: 40-10198

Banner



P/N: 40-10210

*To purchase any of the items above, view airflow charts, dyno graphs, photos, and video; please go to aFepower.com.



Warranty

General Terms:

- aFe warrants their products to be free from manufacturer's defects due to workmanship and material.
- This warranty applies only to the original purchaser of the product and is non-transferrable.
- Proof of purchase of the aFe product is required for all warranty claims.
- Warranty is valid provided aFe instructions for installation and/or cleaning were properly followed.
- Proper maintenance with regular inspections of product is required to insure warranty coverage.
- Damage due to improper installation, abuse, unauthorized repair or alteration is not warranted.
- Incidental or consequential damages or cost, including installation and removal of part, incurred due to failure of aFe product is not covered under this warranty.
- All warranty is limited to the repair and/or replacement of the aFe part. To request Return Goods Authorization ("RGA"), email RGA@afepower.com or call (951)493-7100. Upon receipt of the RGA, you must return the product to the address provided in the RGA, freight prepaid and accompanied with a dated proof of purchase and the RGA. Upon receipt of the defective product and upon verification of proof of purchase, aFe will either repair or replace the defective product within a reasonable time, not to exceed thirty days.

Product Category	P/N Prefix	Warranty duration
Direct OE Replacement Filters	10, 11, 30, 31, 71, 73	Life of the vehicle
Racing Filters	18	1 year
Universal	20, 21, 23, 24, 72, TF	2 years
Air Intake Systems	50, 51, 53, 54, 55, 56, 57, 58, 75, TR, TA, TL, TM	2 years
Exhaust Systems	49	2 years
Intercoolers & Intercooler Tubes	46-2	2 years
Intake Manifolds	46-1	2 years
Differential Cover	46-7	Life of the vehicle
Exhaust Manifolds	46	2 years
Throttle Body Spacers	46-3	2 years
Turbochargers	46-6	2 years*
Fluid Filters	44	90 days
Pre-Filters	28	2 years
Heavy Duty OE Replacement	70	2 years
PowerSports OE Replacement	81, 87	2 years
PowerSports Intake Systems	85	2 years

No other warranty expressed or implied applies nor is any person or advanced FLOW engineering authorized to assume any other warranty. Some States do not allow the exclusion or limitation of incidental or consequential damages or do not allow limitations on how long an implied warranty lasts, so the above limitations or exclusions may not apply to you. This warranty gives you specific legal rights, and you may also have other rights which vary from State to State.

*See turbocharger warranty for more info.

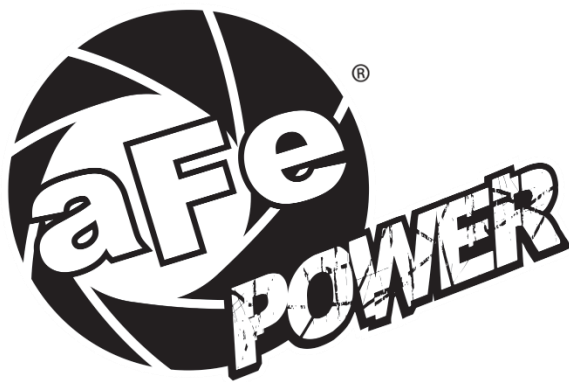

advanced FLOW engineering, inc.

252 Granite Street Corona, CA 92879
TEL: 951.493.7100 • TECH: 951.493.7185
E-Mail: Tech@aFepower.com

6/3/2021 JTP