



CAN DISPLAY DASH & LOGGER SYSTEM USER GUIDE



CD-7/CD-7 Carbon

Part Number	Description
30-5500	Aluminum Enclosure, Non-Logging
30-5501	Aluminum Enclosure, Logging
30-5502	Aluminum Enclosure, Non-Logging with VDM
30-5503	Aluminum Enclosure, Logging with VDM
30-5700	Carbon Fiber Enclosure, Non-Logging
30-5701	Carbon Fiber Enclosure, Logging
30-5702	Carbon Fiber Enclosure, Non-Logging with GPS
30-5703	Carbon Fiber Enclosure, Logging with GPS
30-5700F	Flat Panel, Carbon Fiber Enclosure, Non-Logging
30-5701F	Flat Panel, Carbon Fiber Enclosure, Logging
30-5702F	Flat Panel, Carbon Fiber Enclosure, Non-Logging with GPS
30-5703F	Flat Panel, Carbon Fiber Enclosure, Logging with GPS

CD-5 Carbon

Part Number	Description
30-5600	Carbon Fiber Enclosure, Non-Logging
30-5601	Carbon Fiber Enclosure, Logging
30-5602	Carbon Fiber Enclosure, Non-Logging with GPS
30-5603	Carbon Fiber Enclosure, Logging with GPS
30-5600F	Flat Panel, Carbon Fiber Enclosure, Non-Logging
30-5601F	Flat Panel, Carbon Fiber Enclosure, Logging
30-5602F	Flat Panel, Carbon Fiber Enclosure, Non-Logging with GPS
30-5603F	Flat Panel, Carbon Fiber Enclosure, Logging with GPS

AEM Performance Electronics
 2205 126th Street Unit A, Hawthorne, CA 90250
 Phone: (310) 484-2322 Fax: (310) 484-0152
<http://www.aemelectronics.com>
 Instruction Part Number: 10-5500-B
 Document Build 1/18/2019

Introducing The AEM CAN Dash

The AEM Color Dash Display and CAN Logger includes the AEM Dash color display and AEM DashDesign editing software. Screen pages are designed graphically. The screen layout displayed in AEM DashDesign is identical to the layout displayed on the AEM Dash.

In addition to the graphical display editor, AEM DashDesign also provides a comprehensive setup editor to program the input, output and mathematical functionality of the AEM Dash.

Once created, setups are uploaded to the AEM Dash via a USB link.

Kit Contents

30-5500 Contents:

- 1 x CD-7
- 4 x AV Mount Hardware (attached to dash)
- 1 x I/O harness
- 1 x power harness
- 1 x USB communication cable
- documentation



30-5501 Contents:

- 1 x CD-7L
- 4 x AV Mount Hardware (attached to dash)
- 1 x I/O harness
- 1 x power harness
- 1 x USB communication cable
- 1 x USB bulkhead extension cable
- documentation



30-5600 Contents:

- 1 x CD-5
- 4 x AV Mount Hardware (attached to dash)
- 1 x I/O harness
- 1 x power harness
- 1 x USB communication cable
- documentation

**30-5600F Contents:**

- 1 x CD-5F
- 4 x AV Mount Hardware (attached to dash)
- 1 x I/O harness
- 1 x power harness
- 1 x USB communication cable
- documentation



30-5601 Contents:

- 1 x CD-5L
- 4 x AV Mount Hardware (attached to dash)
- 1 x I/O harness
- 1 x power harness
- 1 x USB communication cable
- 1 x USB bulkhead extension cable
- documentation

**30-5601F Contents:**

- 1 x CD-5LF
- 4 x AV Mount Hardware (attached to dash)
- 1 x I/O harness
- 1 x power harness
- 1 x USB communication cable
- 1 x USB bulkhead extension cable
- documentation



30-5602 Contents:

- 1 x CD-5G
- 4 x AV Mount Hardware (attached to dash)
- 1 x I/O harness
- 1 x power harness
- 1 x USB communication cable
- 1 x GPS Antenna
- 1 x Velcro
- documentation

**30-5602F Contents:**

- 1 x CD-5GF
- 4 x AV Mount Hardware (attached to dash)
- 1 x I/O harness
- 1 x power harness
- 1 x USB communication cable
- 1 x GPS Antenna
- 1 x Velcro
- documentation



30-5603 Contents:

- 1 x CD-5LG
- 4 x AV Mount Hardware (attached to dash)
- 1 x I/O harness
- 1 x power harness
- 1 x USB communication cable
- 1 x USB bulkhead extension cable
- 1 x GPS Antenna
- 1 x Velcro
- documentation

**30-5603F Contents:**

- 1 x CD-5LGF
- 4 x AV Mount Hardware (attached to dash)
- 1 x I/O harness
- 1 x power harness
- 1 x USB communication cable
- 1 x USB bulkhead extension cable
- 1 x GPS Antenna
- 1 x Velcro
- documentation



30-5700 Contents:

- 1 x CD-7 Carbon
- 4 x AV Mount Hardware (attached to dash)
- 1 x I/O harness
- 1 x power harness
- 1 x USB communication cable
- documentation

**30-5700F Contents:**

- 1 x CD-7F Carbon
- 4 x AV Mount Hardware (attached to dash)
- 1 x I/O harness
- 1 x power harness
- 1 x USB communication cable
- documentation



30-5701 Contents:

- 1 x CD-7L Carbon
- 4 x AV Mount Hardware (attached to dash)
- 1 x I/O harness
- 1 x power harness
- 1 x USB communication cable
- 1 x USB bulkhead extension cable
- documentation

**30-5701F Contents:**

- 1 x CD-7LF Carbon
- 4 x AV Mount Hardware (attached to dash)
- 1 x I/O harness
- 1 x power harness
- 1 x USB communication cable
- 1 x USB bulkhead extension cable
- documentation



30-5702 Contents:

- 1 x CD-7G Carbon
- 4 x AV Mount Hardware (attached to dash)
- 1 x I/O harness
- 1 x power harness
- 1 x USB communication cable
- 1 x GPS Antenna
- 1 x Velcro
- documentation

**30-5702F Contents:**

- 1 x CD-7GF Carbon
- 4 x AV Mount Hardware (attached to dash)
- 1 x I/O harness
- 1 x power harness
- 1 x USB communication cable
- 1 x GPS Antenna
- 1 x Velcro
- documentation



30-5703 Contents:

- 1 x CD-7LG Carbon
- 4 x AV Mount Hardware (attached to dash)
- 1 x I/O harness
- 1 x power harness
- 1 x USB communication cable
- 1 x USB bulkhead extension cable
- 1 x GPS Antenna
- 1 x Velcro
- documentation

**30-5703F Contents:**

- 1 x CD-7LGF Carbon
- 4 x AV Mount Hardware (attached to dash)
- 1 x I/O harness
- 1 x power harness
- 1 x USB communication cable
- 1 x USB bulkhead extension cable
- 1 x GPS Antenna
- 1 x Velcro
- documentation

**Dash Features**

- Full color CAN display and logger (logging versions only)
- Completely user definable CAN receive
- Dual CAN bus
- Full graphics display with up to 6 different pages
- Unit ships with 6 display pages for the AEMNet data stream as the default setup
- Completely user definable graphical layouts
- Stand-alone PC program to create and customize layouts
- Water resistant enclosure with rear facing DTM 12 pin connector
- 7" or 5" (diag) 800x480 super bright color display

- Night mode input
- 7 shift lights and 2 alarm LEDs
- 200mb onboard logging memory (logging versions only)
- Up to 1000hz sample rate (logging versions only)
- Onboard 5Hz GPS/GLONASS receiver (GPS versions only)
- Log data downloaded and viewed with AEMdata via USB port with sealed bulkhead extension cable (logging versions only)
- Beacon input

Dash Mechanical and Mounting

CD-7 Mechanical

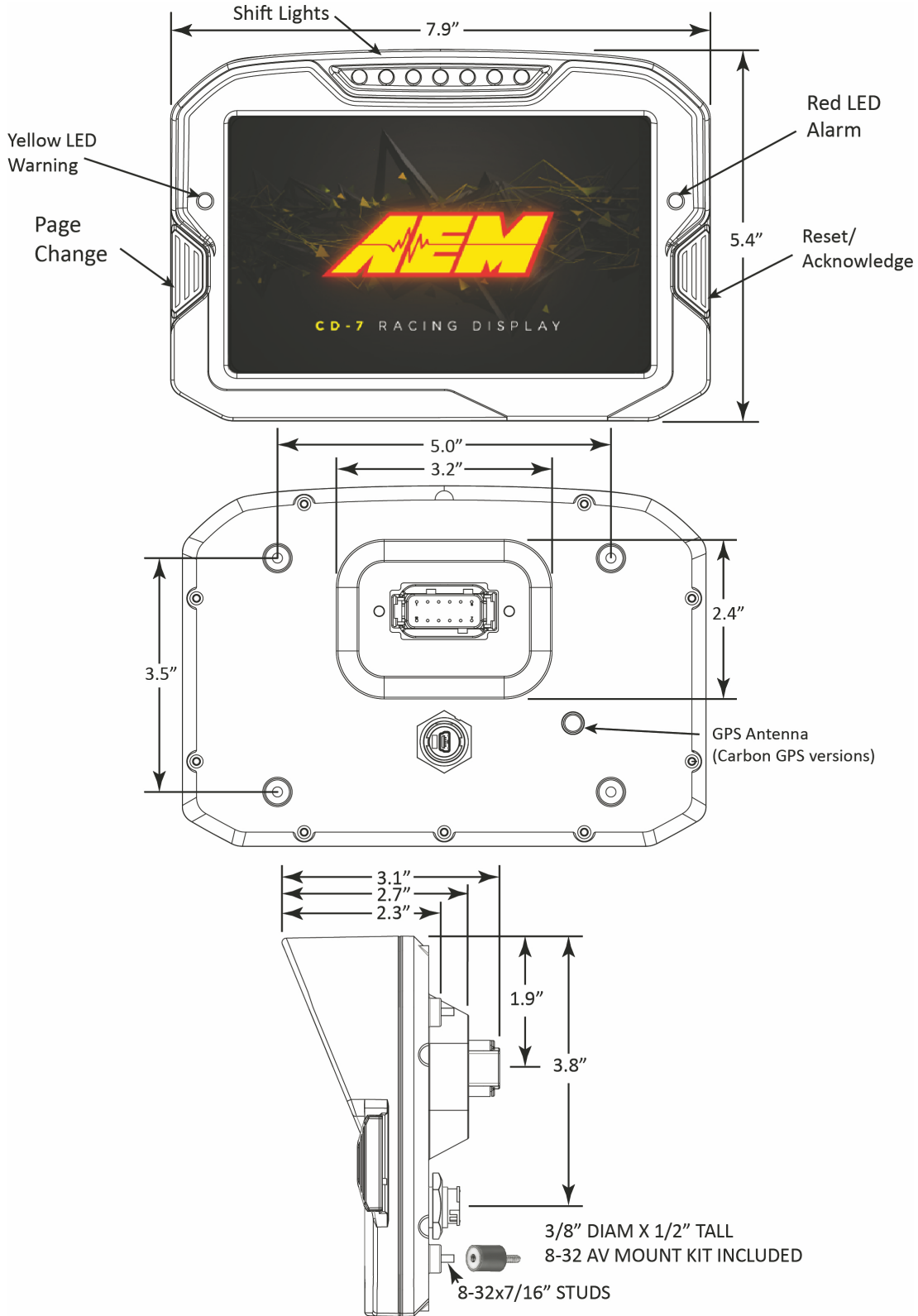

CD-5 Mechanical

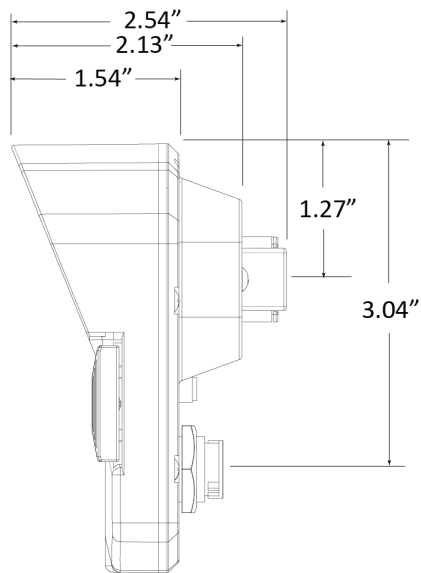
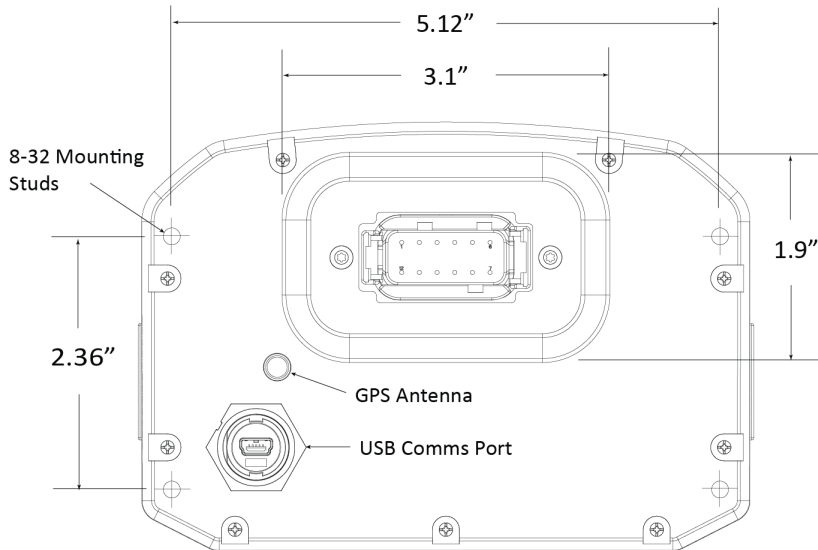
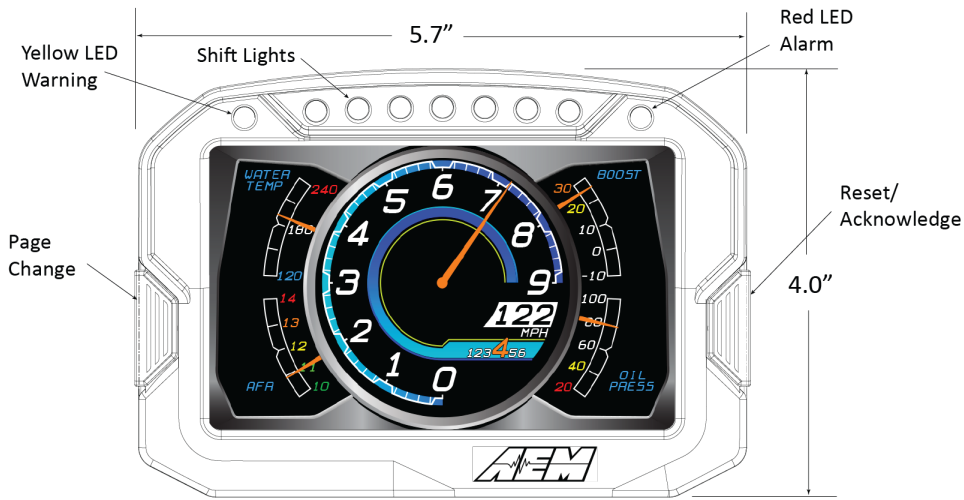

CD-7F Mechanical

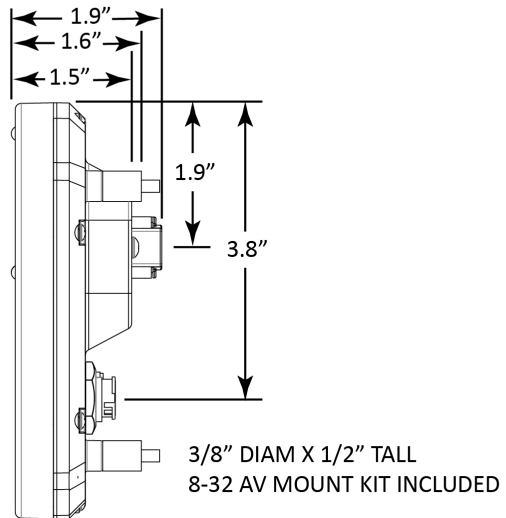
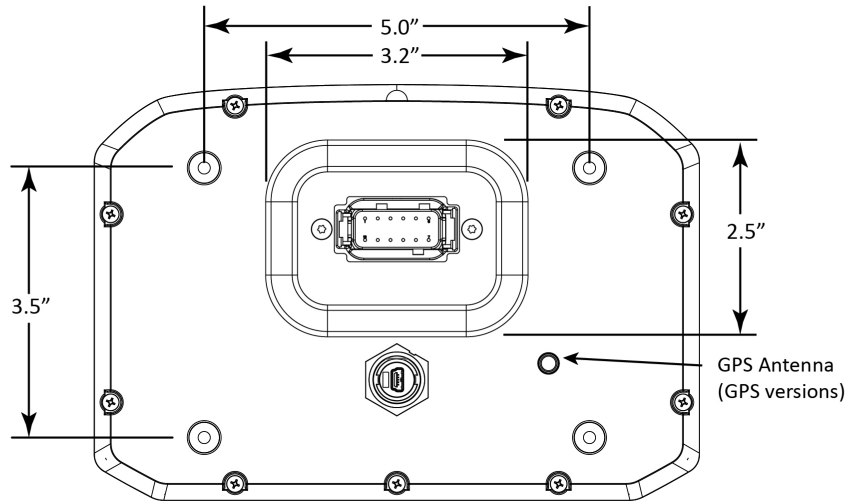
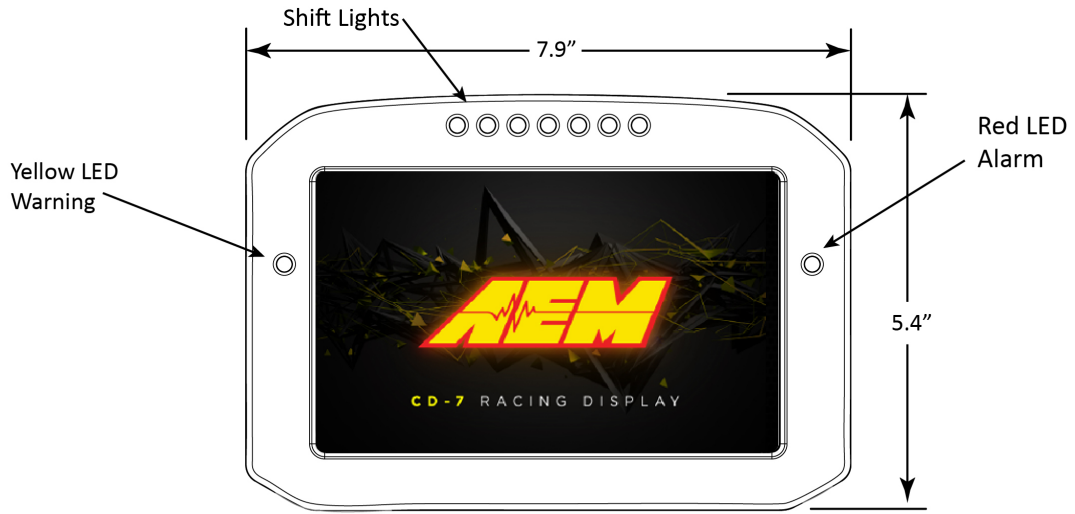

CD-5F Mechanical

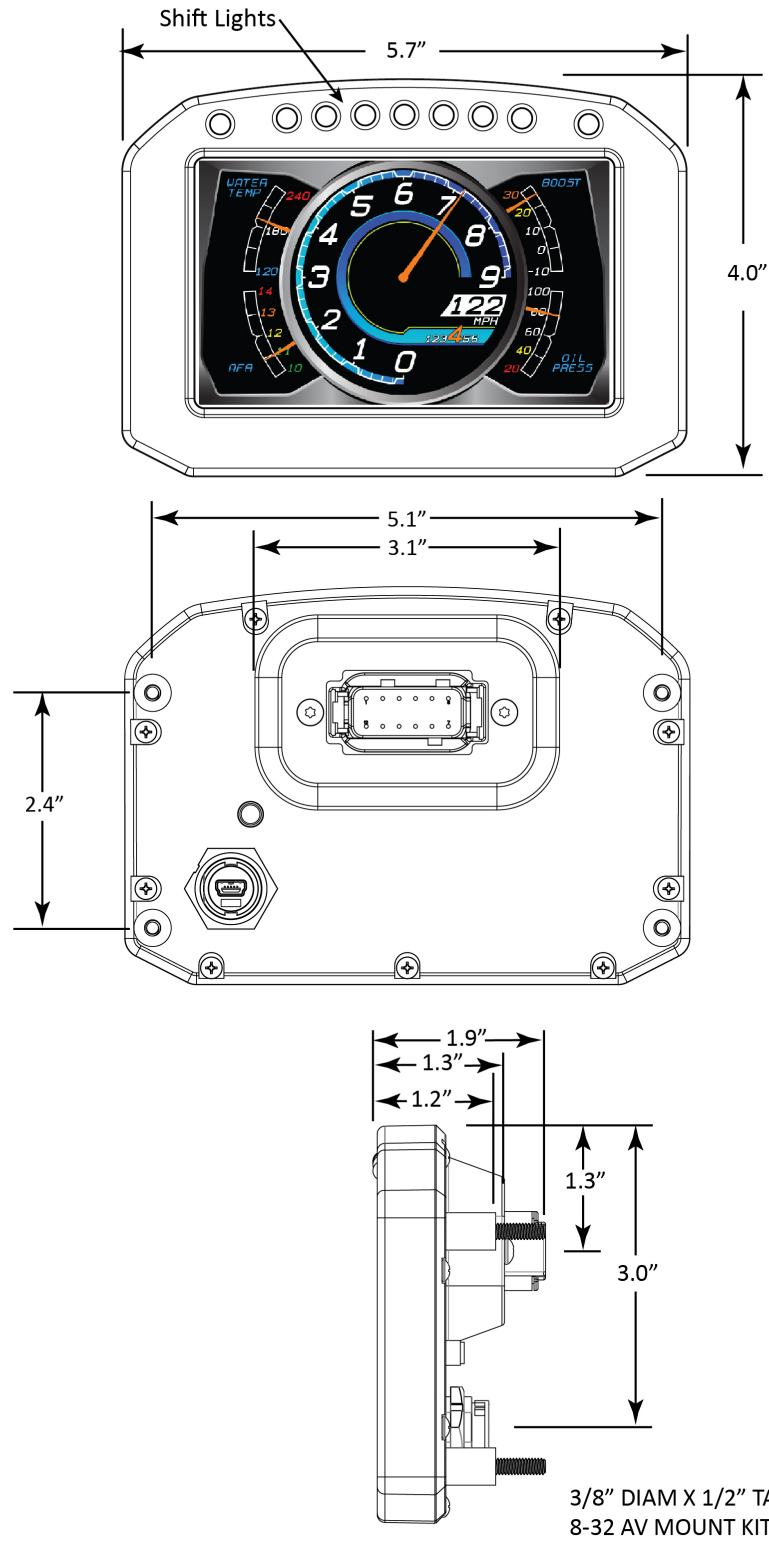

Drill Template

Drill template prints to scale.



Dash Harness and Basic Wiring

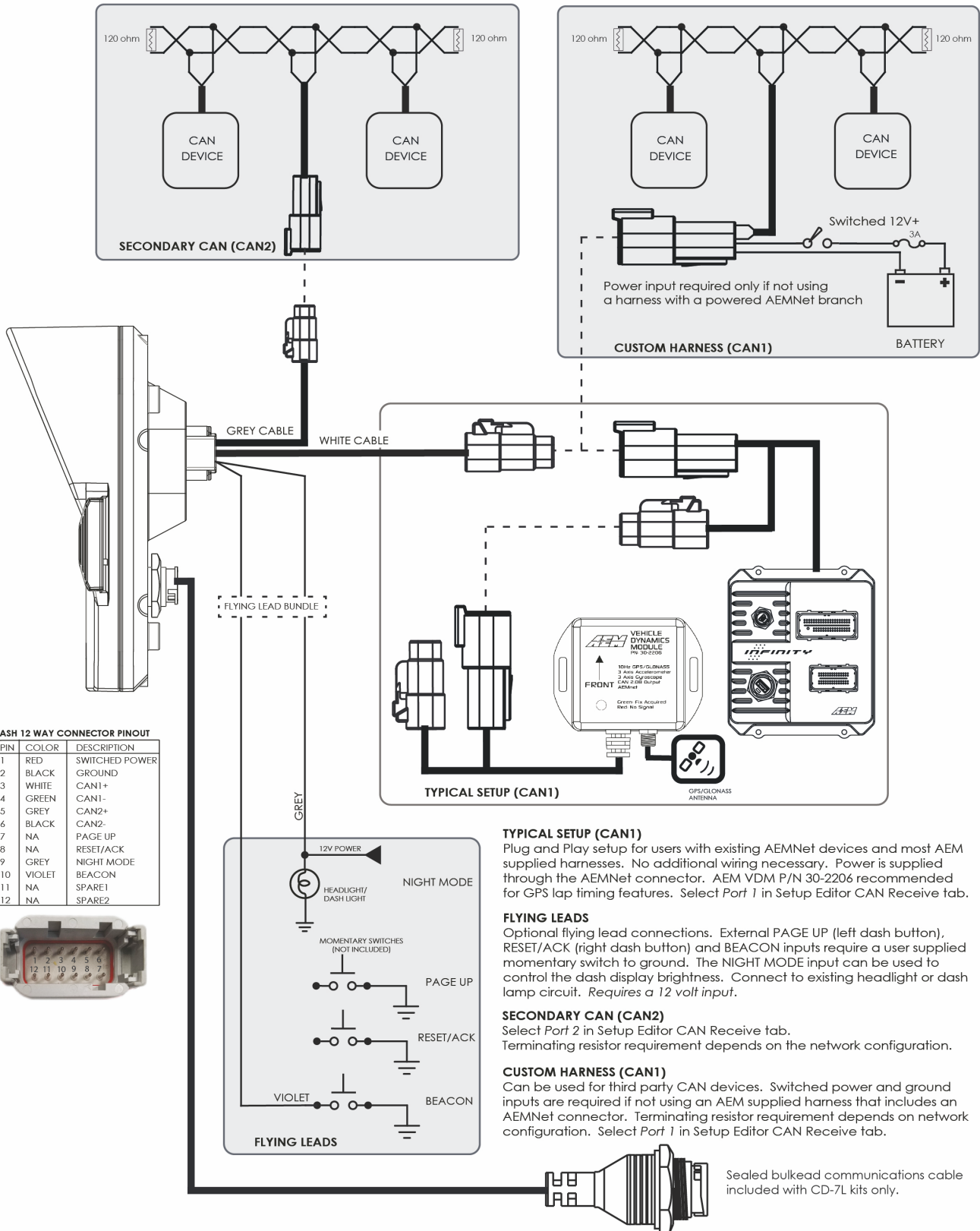

Drawing: BASIC HARNESS WIRING

PRODUCT: AEM CD-7/CD-7L
 AEM CD-5/CD-5L

Date: 11/29/2017

Rev: E

Engineer:

Optional OBDII and Power Cable Kits

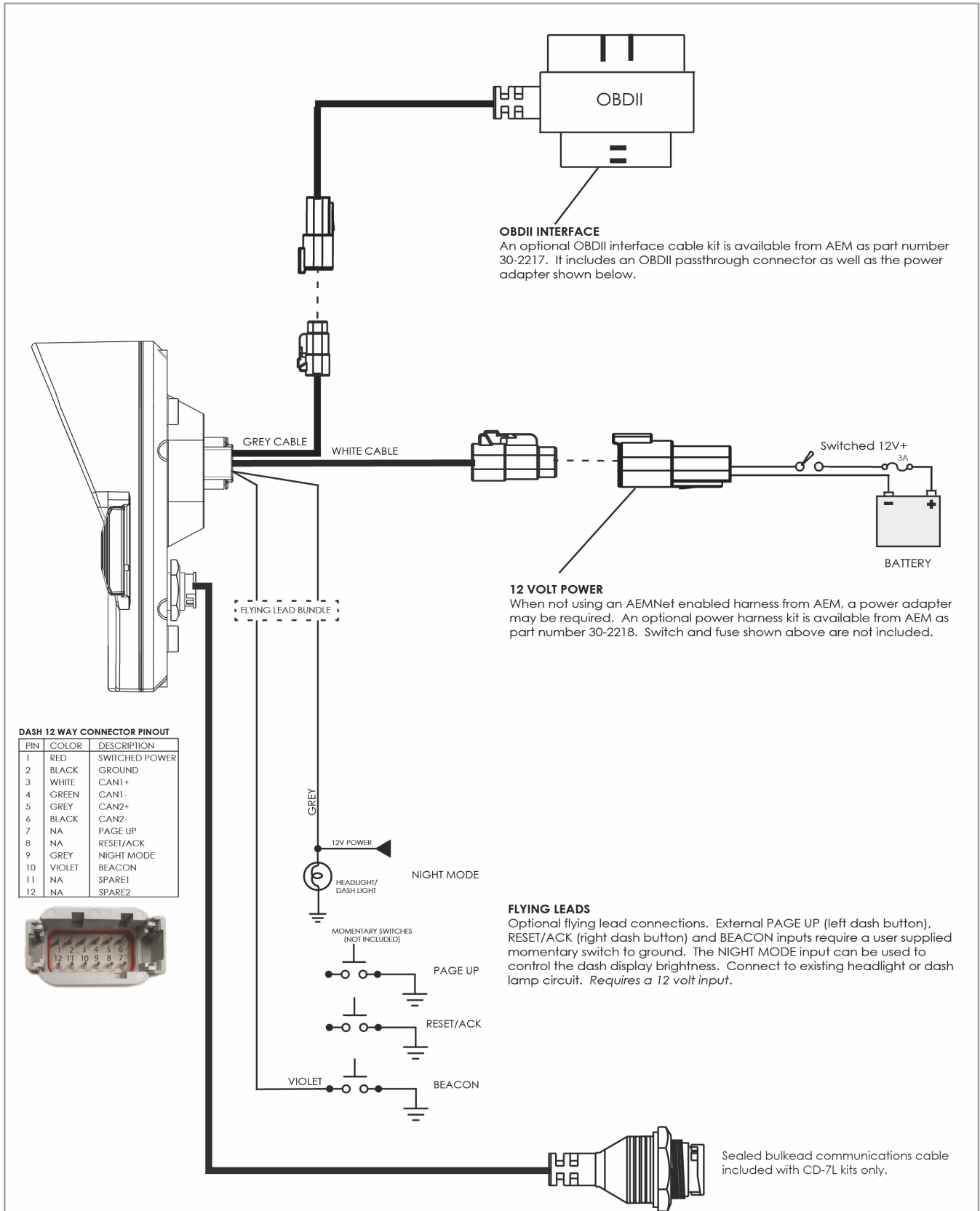

DASH 12 WAY CONNECTOR PINOUT

PIN	COLOR	DESCRIPTION
1	RED	SWITCHED POWER
2	BLACK	GROUND
3	WHITE	CAN1+
4	GREEN	CAN1-
5	GREY	CAN2+
6	BLACK	CAN2-
7	NA	PAGE UP
8	NA	RESET/ACK
9	GREY	NIGHT MODE
10	VIOLET	BEACON
11	NA	SPARE1
12	NA	SPARE2



Drawing: **OPTIONAL OBDII AND POWER WIRING**

PRODUCT: AEM CD-7/CD-7L
AEM CD-5/CD-5L

Date: 11/29/2017

Rev: C

Engineer:

Optional Momentary Button Kit

Description

AEM kit part number 30-3610 - Panel mount momentary push buttons. Each kit includes 2 buttons, serrated lock washers and nuts. Buttons are sealed with flying leads.



Panel Cut-Out

THICKNESS 1.5 to 4.0mm

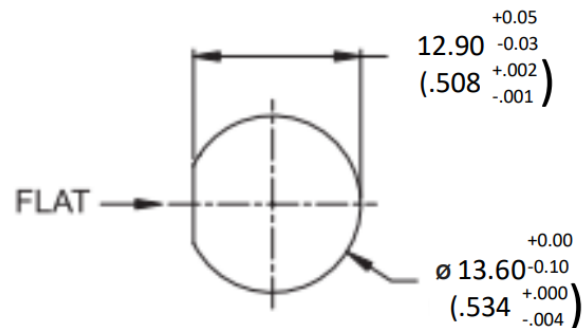

Note: a 35/64" drill bit may be used.

Features

- IP68 rated
- Normally open
- Flying leads, 20"

Kit Contents

- 1x Blue Button with o-ring, lock washer and nut
- 1x Yellow Button with o-ring, lock washer and nut
- User Instructions

Specifications

- Current rating: 200mA (DC)
- Electrical Life: 500,000 cycles
- Mechanical Life: 1,000,000 Cycles
- Ingress protection: IP68 – Dust Tight, Waterproof
- Mounting type: Panel Mount, Circular, 13.60mm Diam Cutout
- Operating Temperature: -30 to 85 deg C
- Voltage Rating: 50V (DC)

Wiring Schematic

HARNESS 12 WAY CON PINOUT

PIN	COLOR	DESCRIPTION
1	RED	SWITCHED POWER
2	BLACK	GROUND
3	WHITE	CAN1+
4	GREEN	CAN1-
5	GREY	CAN2+
6	BLACK	CAN2-
7	BLUE	PAGE UP
8	YELLOW	RESET/ACK
9	GREY	NIGHT MODE
10	VIOLET	BEACON
11	NA	SPARE1
12	NA	SPARE2

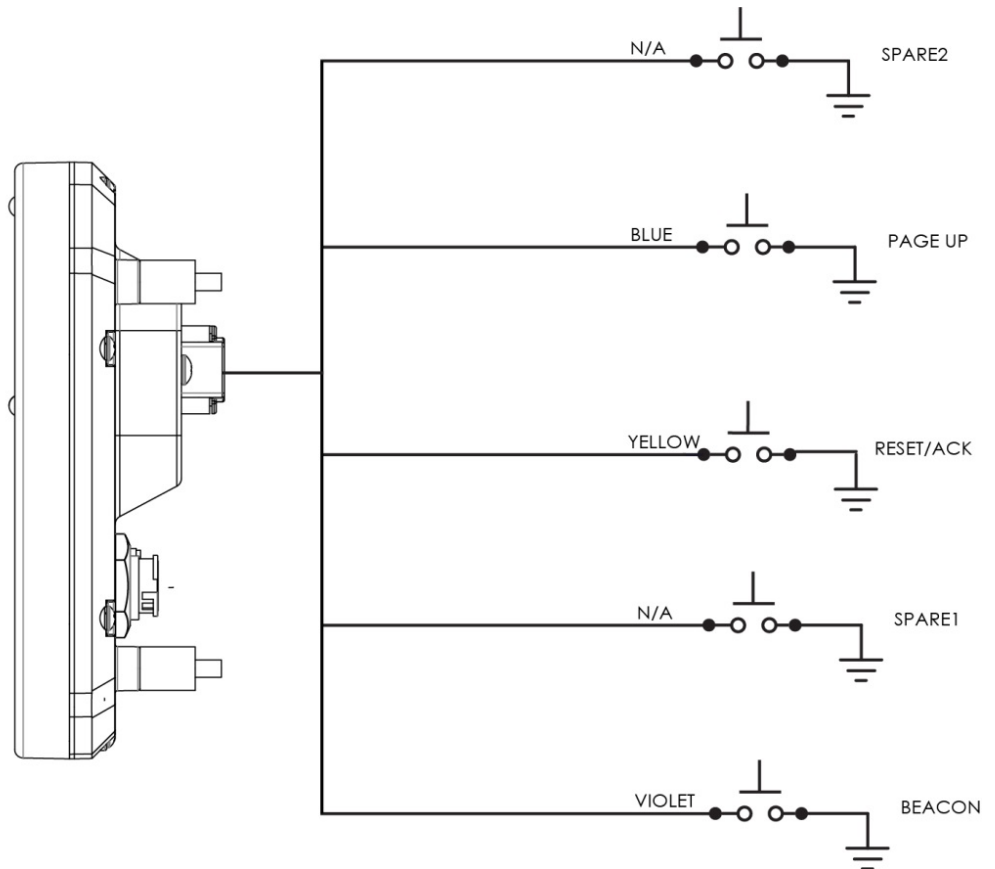

Installing AEM DashDesign

AEM DashDesign is distributed as a single install executable. To install, run AEM DashDesign Setup.exe and follow the on-screen instructions including those requiring you to restart your PC if necessary.

Installing USB Drivers

The installation program will automatically install the USB drivers required by AEM Dash. However, on rare occasions, it may be necessary to install the USB drivers manually. To do this:

- Connect the AEM Dash to the PC.
- When the add new hardware wizard appears, select "Install from a list or specific location" and click Next.
- Choose "Search for the best driver in these locations" and check "Include this location in the search"
- Click the Browse button and navigate to the Drivers folder sub folder in the AEM DashDesign installation directory.
- Click the Next button and the driver installation will proceed automatically.

Air/Fuel Sensors and Devices to Dash

The AEMNet CAN message transmission is enabled by default on the following devices. Refer to your harness documentation to identify the CAN terminals.

30-03X0 X-Series UEGO
 30-4900 Wideband Failsafe
 30-4911 Flex Fuel Failsafe
 30-2340 4Ch UEGO

Series 2 EMS and EMS-4 to Dash

The AEMNet CAN output must be enabled in your ECU before the dash can receive messages. Select **Wizards | Setup Wizard** and choose Telemetry: AEMNet from the Wizard Types column. Left click on the Configuration Name AEMNet Datastream and click the Apply button to enable.

Infinity to Dash

The AEMNet CAN message transmission is enabled by default on Infinity ECUs. No additional software setup in your ECU calibration is required. Refer to your harness documentation or Infinity hardware specification document to identify the CAN terminals.

VDM to Dash

The AEM Vehicle Dynamics Module, PN 30-2206 can be used in conjunction with the AEM dash for lap timing and track mapping features.



VDM Features:

- GPS latitude & longitude delivers AEMdata track map functionality via AEMnet CAN bus
- Easily Add GPS, lateral G, altitude, pitch and roll data to engine data logs
- Simply install it in the correct position, connect to AEMnet and the data streams through AEMnet CAN bus
- Continuous time data can be used for Infinity USB log file naming
- Accelerometers supply all 3-axis acceleration data for chassis tuning

- Ideal for road racers who want to use the gyrometer data for suspension adjustments
- Perfect for drag racers who want G-loads and wheel stand data
- GPS vehicle speed, heading and altitude logged for data analysis, lap comparisons
- Status LED indicates power & GPS signal
- Weather resistant enclosure with IP67 rated GPS/GLONASS antenna

Go to **Setup | Lap Timing...** Select the GPS button to configure for GPS lap timing. A virtual start/finish line creation feature allows you to use the beacon input (violet wire in flying lead harness) to set a virtual start/finish line. While driving the course, press the momentary beacon switch when you cross the start/finish line. Hold for a few seconds until the left and right LEDs flash. The system captures the location information when you first press the button. Holding for a few seconds eliminates the likelihood of false triggering the input. You can define your virtual track width in the dialog window. Set to the approximate width of the track surface plus some extra. The dash creates a start finish line the width of the track perpendicular to the heading when the start finish is set. It then checks whether the previous two points cross this line; the only caveat being that the heading is +/- 90 degrees of the original heading.

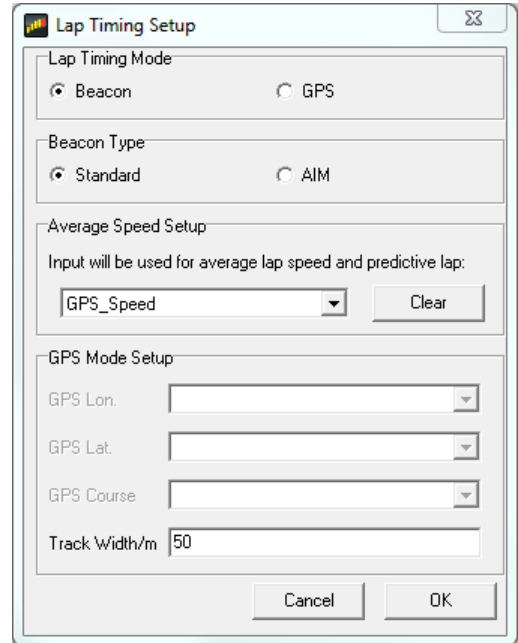

Installation

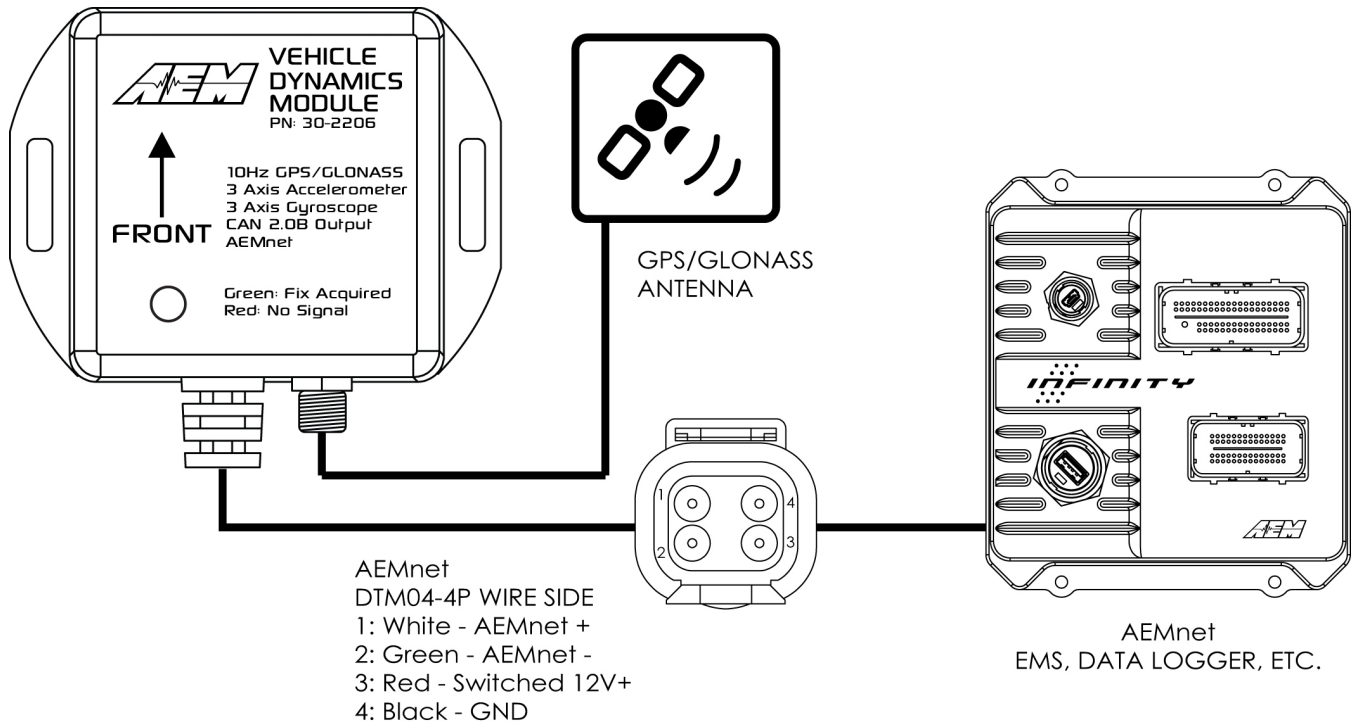

The VDM is equipped with an AEMnet connector (power, ground, and CAN) so that it is a true plug and play experience when used with other AEMnet products such as the Infinity ECU.

Ideally, the VDM module should be installed near the center (both fore/aft and side-to-side) of the vehicle and as low as possible. For example, the module may be mounted to the floor of the vehicle between the two front seats. The module should be mounted using the provided "hook-and-loop" material or may be more rigidly mounted using fasteners through the module's mounting ears. Take care to avoid over-torquing mounting fasteners, if used.

The antenna should be mounted in a location where the top is pointed towards, and has a clear view of, the sky. The bottom of the antenna is magnetic or additional hook-and-loop material is provided for mounting; the dashboard or rear package shelf are **not** acceptable locations. The antenna should be mounted as high as possible in the center of a metal roof away from other antennas or structures. If the roof of the vehicle is non-metallic then a flat piece of metal at least five inches in diameter, to function as a ground plane, should be fabricated upon which the antenna should be placed.

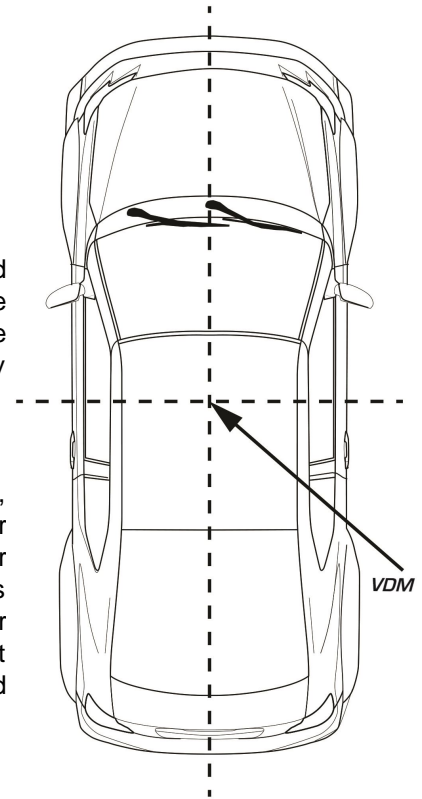

Status LED

There is a status LED located on the top of the VDM module that gives an indication of its operating status, specifically the quality of the current GPS signal:

LED	Description
OFF	The device is not powered
FLASHING RED	No valid GPS fix
FLASHING GREEN	Less than 4 satellites in view
GREEN	4 or greater satellites in view
OTHER	Please contact AEM Support

Channels / Data

GPS

The VDM utilizes an internal 10Hz GPS/GLONASS receiver with a matching external active antenna. Faster time to fix, and better global coverage is afforded by the support of both the GPS and GLONASS constellations. The module is designed with an internal battery that will retain the last known satellite position (ephemeris) while power is disconnected from the VDM for several days. This will allow for a very fast time to fix (<1 sec typ) once the device is turned on again; if power is removed for an extended period of time then the time to fix will increase. The internal battery is automatically recharged and never needs to be replaced.

The following GPS channels are output on AEMnet for logging on your Infinity ECU or other device:

Channel Name	Notes
GPS Latitude [deg]	+ = North, - = South
GPS Longitude [deg]	+ = East, - = West
GPS Speed [mph]	Speed
GPS Altitude [ft]	Above Mean Sea Level (MSL)

GPS Course [deg]	Course over ground, NOT heading
GPS Satellite Count	"Visible" number of satellites
GPS Valid	1 = Valid Fix, 0 = No Fix
GPS Year	UTC Time
GPS Month	UTC Time
GPS Day	UTC Time
GPS Hours	UTC Time
GPS Minutes	UTC Time
GPS Seconds	UTC Time

Accelerometer / Gyroscope

The following accelerations and yaw rate channels are output on AEMnet for logging on your Infinity ECU or other device:

Channel Name	Notes
Acceleration X [g]	*Longitudinal
Acceleration Y [g]	*Lateral
Acceleration Z [g]	*Vertical
YawRate X [deg/s]	*Roll
YawRate Y [deg/s]	*Pitch
YawRate Z [deg/s]	*Yaw

*If +x is mounted in the direction of travel

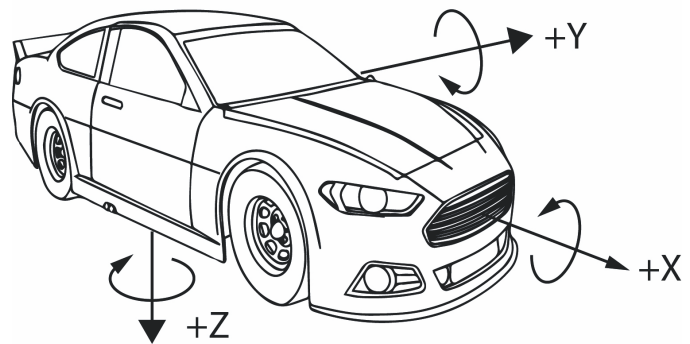

6 Channel CAN Sensor Module to Dash

Kit Contents

The AEM 6 Channel CAN Sensor Module enables a user to put analog, fuel level, and tachometer signals onto an AEMnet or CAN bus. The Sensor Module accommodates a wide variety of sensors and is housed in a sealed IP67 weather-resistant enclosure. Sturdy construction, protected inputs, and simple configuration make this the perfect entry point to get everything required to use an AEM CD-series dash on a carbureted or EFI vehicle. The Sensor Module supports the Bosch CAN 2.0b standard making it compatible with many third-party devices. Note: **The only AEMnet devices that are compatible with the CAN Sensor Module are the CD-series dash displays.**

Features

- Two (2) temperature (thermistor) inputs
- Two (2) dedicated 0-5V analog inputs
- One (1) dedicated fuel level input (0 to 250 Ohm range)
- One (1) tachometer/coil input
- Fixed CAN bus speed, header length, and base address
- IP67 Potted Enclosure / Sealed Connector - "dust tight" and protected against water spray
- Protected inputs

PN	QTY	Description
35-2214	1	MODULE, 6 CHANNEL CAN SENSOR MODU
10-2226	1	INST, MODULE, 22 CHANNEL CAN SENSOI MODULE
1-3080	2	SCREW, FLT HD, 4-40X7/8"
1-2520	2	WASHER, 4-40 x .375"
35-5709	2	NUT, NYLOCK 4-40x9/64
4-1020	2	CONNECTOR, SLD, 12-WY PLG A
4-2013	13	TERMINAL, SKT, SZ 20, .05-.08

Installation

Mechanical

The Sensor Module may be mounted within the vehicle using hook-and-loop fastener (not included) or bolted (#4 screws included) to a suitable structure; a mounting/drill diagram is provided below. The module is weather-resistant (IP67) but is preferably mounted in a cool, dry area such as the driver compartment.

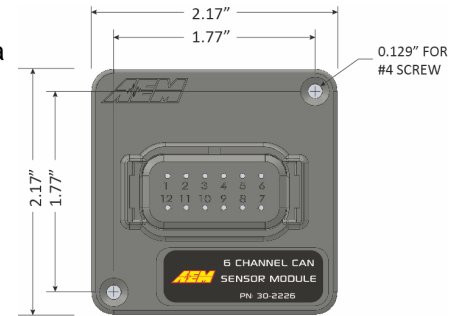

Sensor Wiring

- The Sensor Module should only be powered through the dedicated power and power ground pins, ***not*** sensor ground
- Every connected sensor should be connected to the dedicated *sensor* ground pins to ensure accurate readings
- Do not connect the Module's 5V sensor power to anything *other than* dedicated sensors that require 5V power, e.g. pressure sensors
- Route wiring away from sources of noise such as alternators, ignition components, or other high power/frequency wiring
- Shielded wire is suggested to reduce the susceptibility of noise; the shield should only be grounded/draind on one end of the wiring harness
- CAN wiring should utilize twisted pairs (> 1 TPI); shielding is recommended
- The Sensor Module's sensor ground should be at the same level as the sensor ground of any "tapped" sensors, i.e. existing/OEM sensors that are connected to an external ECU/device
- **The device pinout section includes a Suggested Interface column. This may make integration with an AEM Dash easier as sample layouts will be provided that follow these guidelines.**

Quick Setup with AEM Dash

Be sure to install the latest version of the AEM DashDesign software.

Follow this [Software Download](#) link directly or follow the graphical instructions below.

The website will always contain the latest release version of DashDesign software. Your version number may be different than the example above.

Once installed, you will find a library of setup files in your \Documents\AEM\DashDesign directory. In the \Documents\AEM\DashDesign\Setups\App Specific\AEM 30-2226 6 Ch CAN Sensor Module folder you will find all currently available setup files for your 30-2226 6 Channel CAN Sensor Module. They have a ".aemcd7" extension. The file name describes each one.

Output Name	Operation	Primary Input
_2Step_Fuel	x1 scalar	_2Step_Fuel_raw
_2Step_Spark	x1 scalar	_2Step_Spark_raw
_2Step_Target_Fuel	_2Step_Target_Fuel_scalar	_2Step_Target_Fuel_raw
_2Step_Target_Spark	_2Step_Target_Spark_scalar	_2Step_Target_Spark_raw
_3Step_Fuel	x1 scalar	_3Step_Fuel_raw
_3Step_Spark	x1 scalar	_3Step_Spark_raw
_3Step_Switch	x1 scalar	_3Step_Switch_raw
_3Step_Target_Fuel	_3Step_Target_Fuel_scalar	_3Step_Target_Fuel_raw
_3Step_Target_Spark	_3Step_Target_Spark_scalar	_3Step_Target_Spark_raw
AC_On	x1 scalar	AC_On_raw

A quick primer on basic setup modifications

The display editor is the core tool for editing a setup. To open the tool, go to **Setup | Display...**

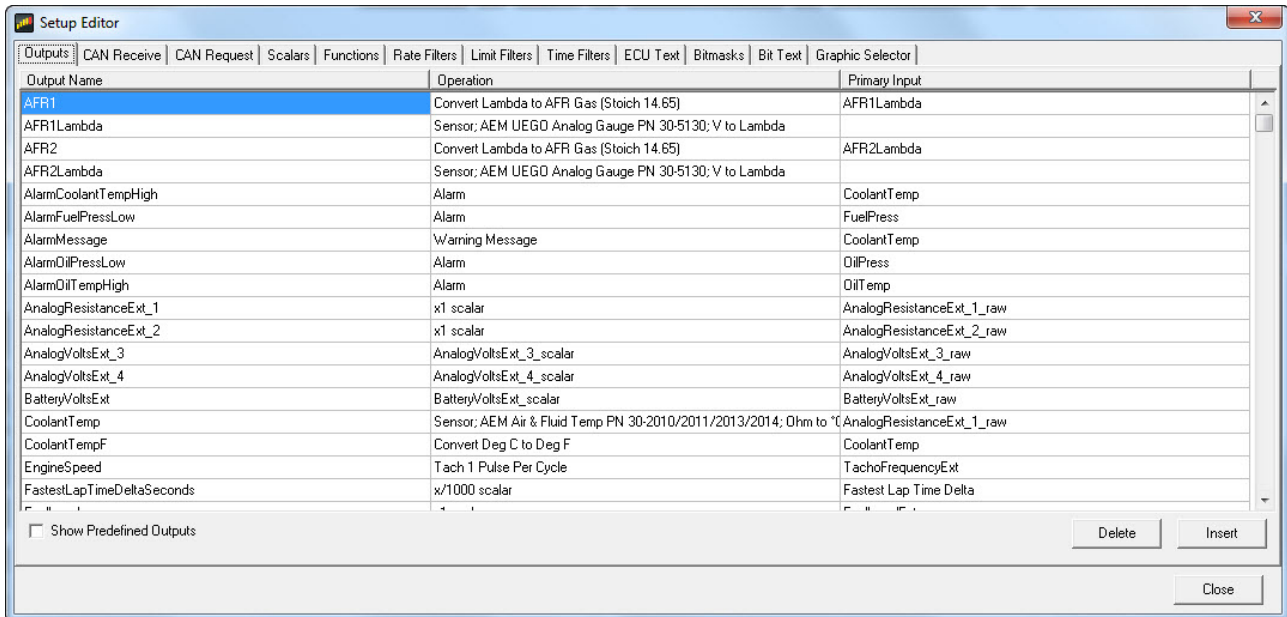

You can think of the display editor as a collection of tools for creating items on your screens. A DashDesign setup consists of four logical components: Primary Inputs, Operations, Outputs and Gauges. These are defined as follows:

- **Primary Inputs** are raw data manipulated by an operation.
- **Outputs** are objects that obtain information from one or more sources or other outputs. An output manipulates the obtained data according to the operation associated with the output. The result can then be used in a gauge or another output.
- **Operations** are objects that define how the data is manipulated by an output. Examples of operations are scalars, functions and alarms.
- **Gauges** are objects that are placed on a screen page. There are two types of gauge; static and variable.
 - **Static** gauges do not change their appearance on the screen and include gauges such as text labels or graphics.
 - **Variable** gauges change their appearance to reflect data obtained from an output. Examples of variable gauges are bar graphs, tachos and numerical text gauges.
- **Predefined Outputs** are pre-configured within the system and can be used in many ways. Some examples include: Log Mem Free (kb) which displays the amount of free logging memory (logging versions only) and Night Mode Input Status. This output displays the state of the Night Mode 12v input (Grey wire in flying lead bundle).

Show Predefined Outputs

Click the Show Predefined Outputs box in the Display Editor to add all Predefined Outputs to the list.

Two common modifications necessary are 1.) Creating a new Pressure Sensor Output and 2.) Modifying the tach output scalar based on the number of engine cylinders.

Creating a new Pressure Sensor Output

Outputs are values, texts or graphics that are used by gauges or other outputs. The output that it passes is determined by the operation that it uses.

To set up a new output:

- Click the Insert button in the Outputs tab.
- Enter the name of the new output. This should describe what the output actually generates.
- Select the operation to be used by the output from the drop-down list.

- Select the input from the drop down list.



In our example below, we will create a new scaled pressure sensor output that can be used to drive a gauge on the dash. It will use the Analog 3 input from the 30-2206 on Pin 7. Three things are required. 1.) You must create a new Output Name. 2.) You must add an Operation to scale the voltage into pressure units. 3.) You must define a Primary Input. First create the new Output Name. We will use *My Pressure*.

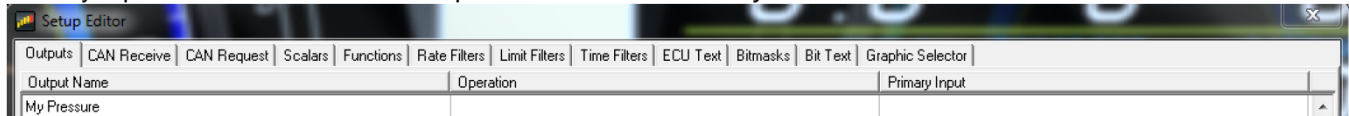

For this example, let's assume that the sensor is a typical 0-5V analog sensor that is calibrated as follows: 0.5 volts = 0 psi and 4.5 volts = 100 psi. Consult your sensor documentation for proper calibration values. There are several options but the easiest method is to use a Function table. Lets create a new Function to define this calibration.

In the Functions tab, create a new Function. We will call it My Pressure Sensor Function; Volts to PSI. It will convert voltage to PSI.

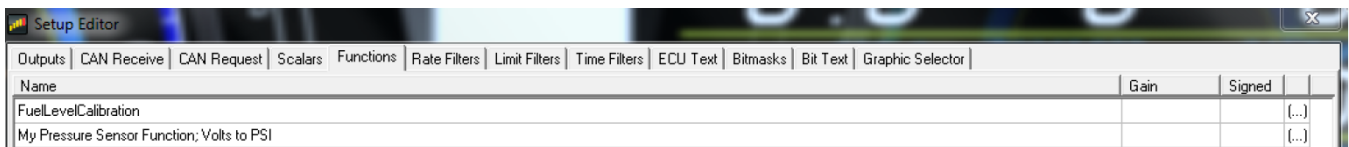

Click on the (...) symbol to define the function table. Enter the data as shown below to create the calibration curve.

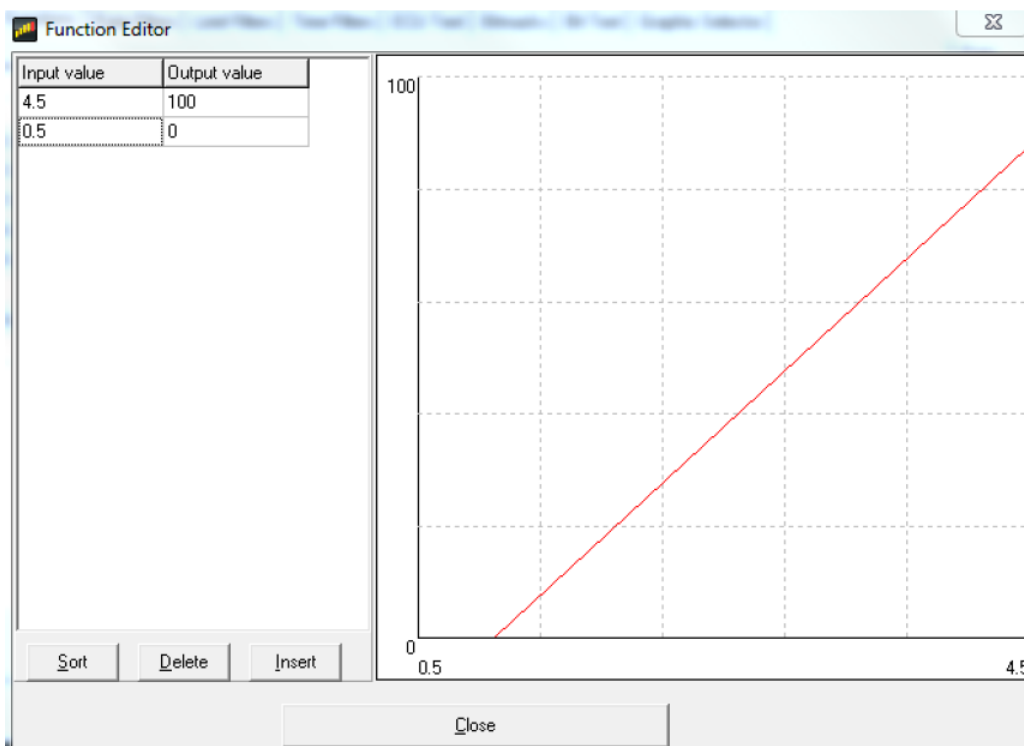

Click the Insert button to add data points. Only two points are required for a linear function. The data is interpolated. More points can be added for non-linear functions.

Next go back to the Outputs tab and choose your new function as the Operation for your new Output.

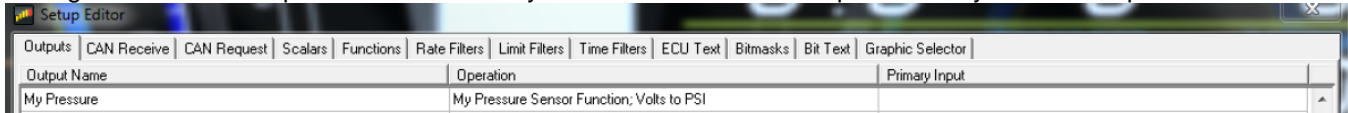

Finally, select the Primary Input which in this case will be AnalogVoltsExt_3

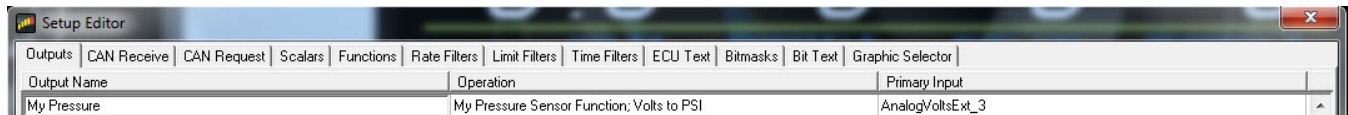

Your new *My Pressure* output can pass pressure sensor data, scaled in units of PSI, from the Analog 3 (Pin 7) input of the 30-2226 CAN Sensor Module to any Gauge item in your Dash setup.

Modifying the tach output scalar

AEM provided dash setup files will include pre-configured tach output scalars. It's very simple to configure your tach input. Find the EngineSpeed output in the Setup Editor. In the example below you can see it uses a scalar for 8 pulses per engine cycle. This is typical for a V8 engine using a distributor/coil combination when the tach input to the 30-2226 is tapped into the coil negative terminal.

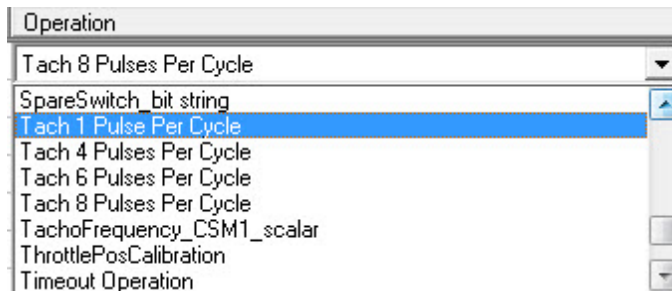

If your tach input has a different number of pulses per cycle, simply select from the other available options.

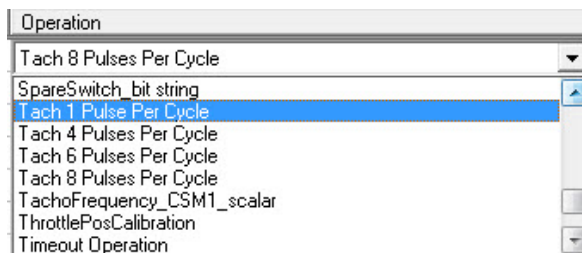

Adding 30-2226 to an Existing CD-X Dash Setup

Open your existing dash set up. Go to Setup-> Display-> CAN Receive-> Import CAN->Select the file 30-2226 CSM6.dbc-> Open. ONLY select the inputs being used. See example below.

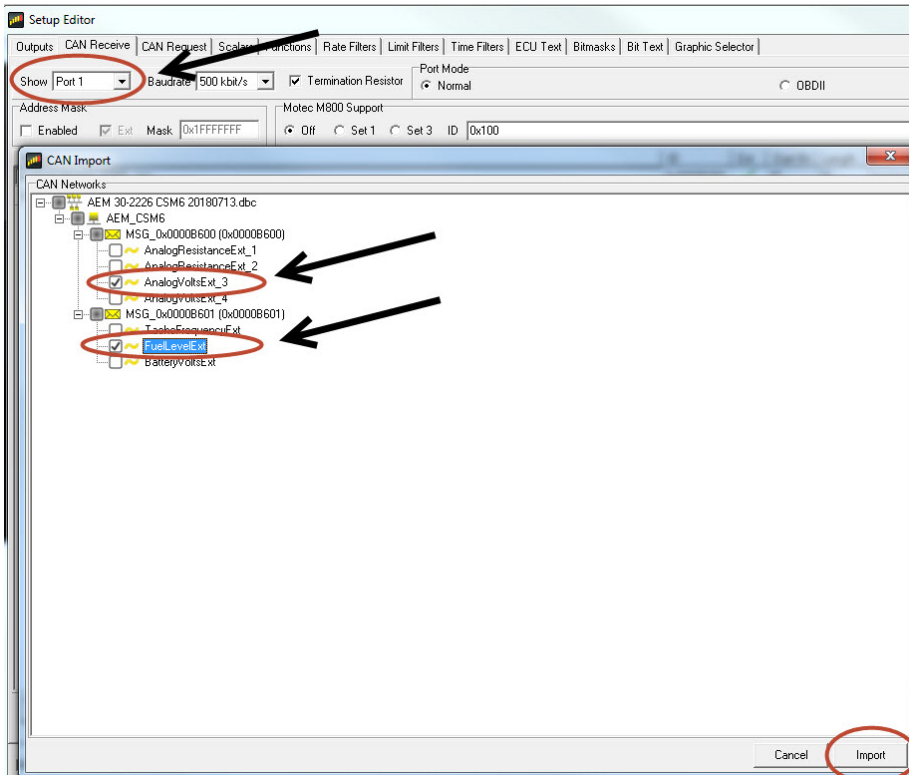

Create functions for sensors that are being used. The data can be obtained from manufacturers data sheet or from user testing. The function name and data (for example..."My Oil Pressure" or "My Fuel level") will need to be entered manually.

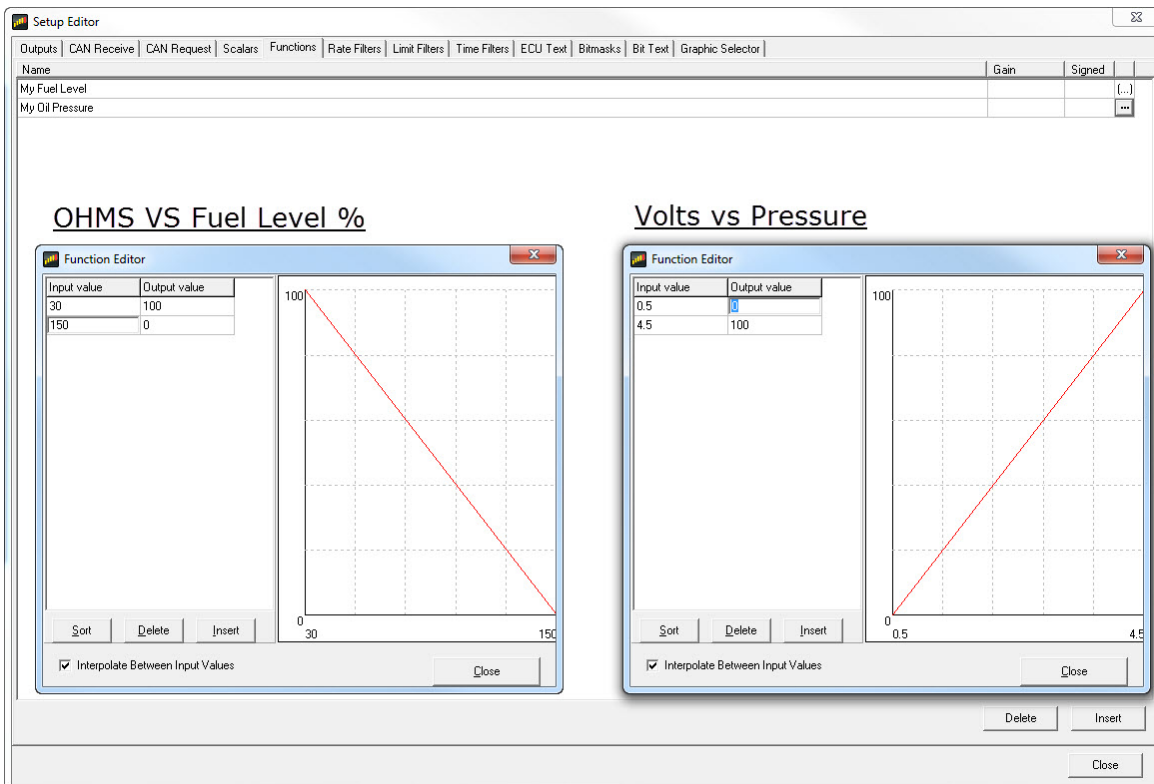

Create a new output/channel using the new function

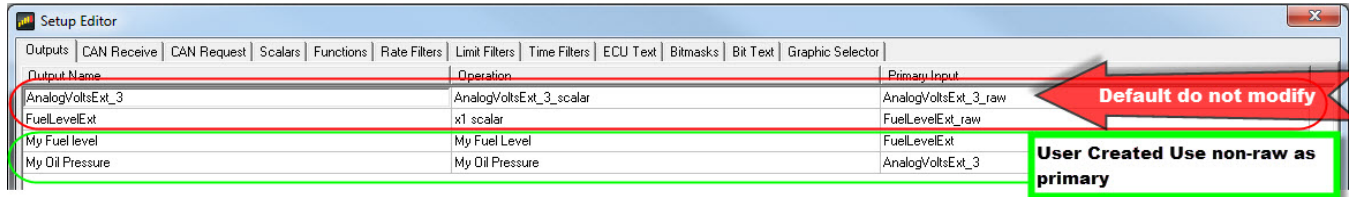

Assign the new output to an item on the display

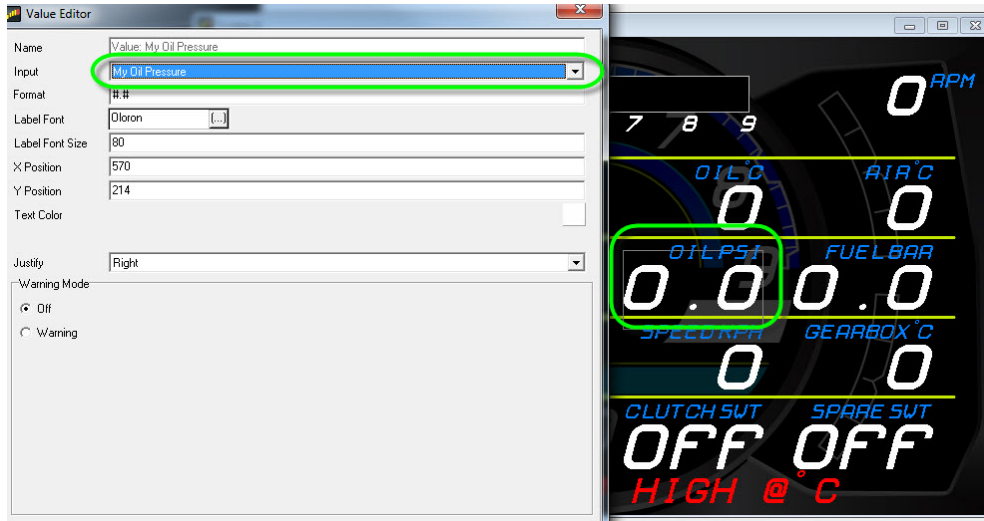

System Schematic

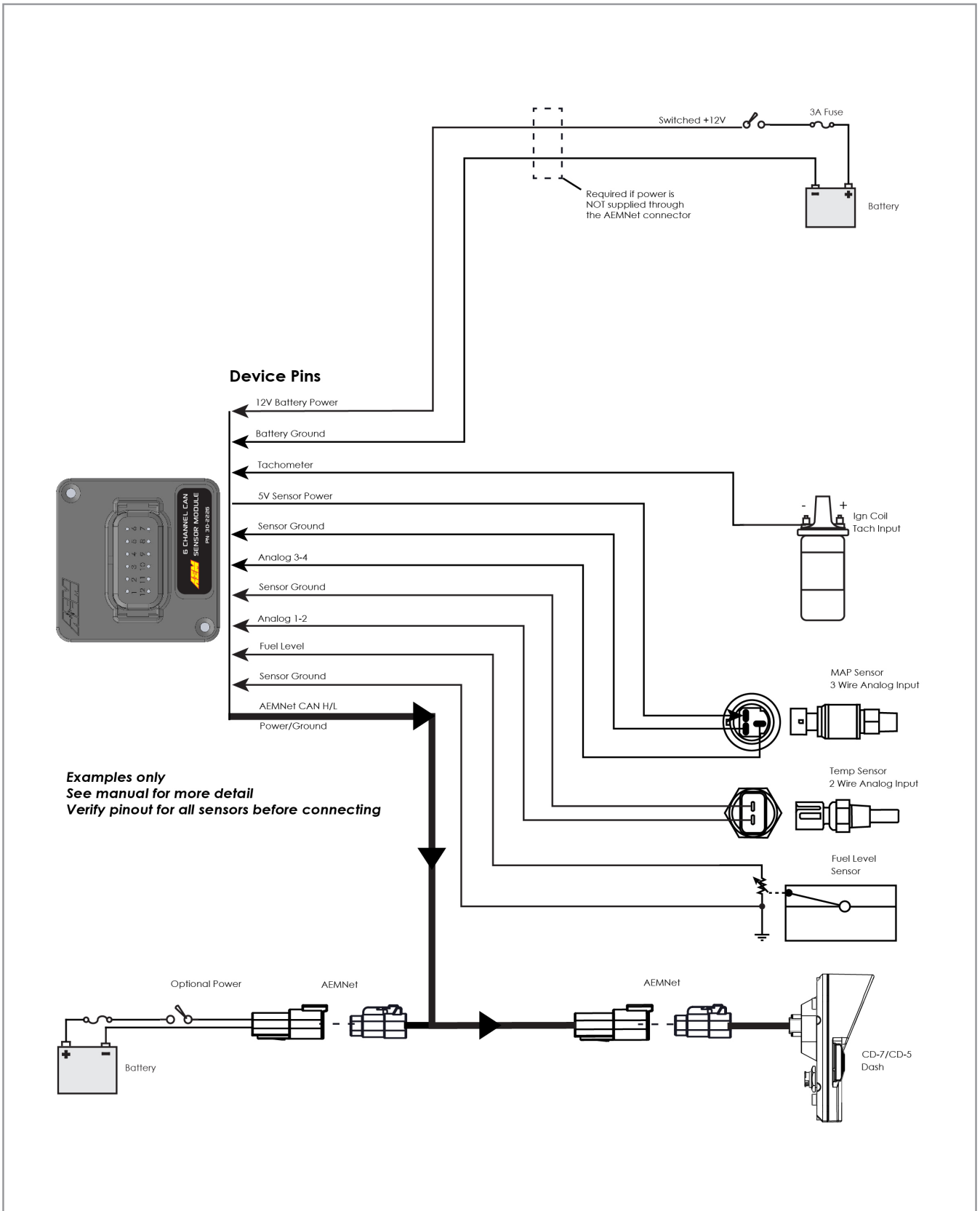

Drawing: SYSTEM SCHEMATIC

30-2226
 PRODUCT: 6 CH CAN Sensor Module

Date: 6/29/2018

Rev:

Engineer:

Device Pinout

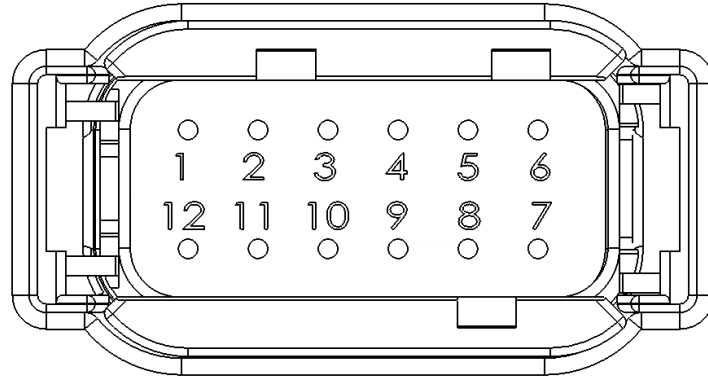

Pin	Name	Function
1	12V Battery Power (+)	Primary ignition/battery power input
2	Battery Ground (-)	Primary ignition/battery ground input
3	AEMnet+ / CANH	AEMnet / CAN bus output
4	AEMnet- / CANL	AEMnet / CAN bus Output
5	Analog 1	Temperature / thermistor input, 2200 Ohm 5V pull-up
6	Analog 2	Temperature / thermistor input, 2200 Ohm 5V pull-up
7	Analog 3	0-5V Analog input, 100k Ohm 5V pull-up
8	Analog 4	0-5V Analog input, 100k Ohm 5V pull-up
9	Tachometer	Engine speed input (negative coil terminal) 12V pull-up
10	Fuel Level	0 - 250 Ohm fuel level sensor input
11	Sensor Ground	Dedicated sensor ground
12	5V Sensor Power	5V sensor reference power output

Analog Inputs 1 - 2

These inputs have a 2200 Ohm 5V pull-up resistor and are suitable for two-wire thermistor temperature sensors. It is not recommended to connect these inputs to pre-existing/OEM sensors that are already connected to a factory ECU or logging device. Please refer to the table below for connection examples.

New / Added Sensors	5V Sensor Power	Sensor Signal	Sensor Ground	Examples
Two wire temperature	✘	✓	✓	Intake, coolant/oil temperature, etc

✓ = Connect

✘=Don't connect

! = Read Notes

CAN Output

The measured resistance will be output via CAN and will have to be scaled to temperature in the receiving device. A thermistor's resistance varies non-linearly with temperature and thus the receiving device will likely require a look-up table to properly log or display temperature. The AEM CD series of dashes have this capability; please refer to the appropriate documentation.

Analog Inputs 3 - 4

These inputs have a 100kOhm 5V pull-up resistor and are suitable to measure voltage signals from 0-5V sensors or devices; either sensors that are being added to a vehicle or pre-existing (or OEM) sensors. Pre-existing/OEM sensors are presumed to be already connected to a factory ECU or logging device which will require different wiring considerations. Please refer to the table below for connection examples.

New / Added Sensors	5V Sensor Power	Sensor Signal	Sensor Ground	Examples
Three wire pressure	✓	✓	✓	Manifold pressure, oil/water pressure, etc
Three wire position	✓	✓	✓	Throttle/pedal position, linear potentiometer, etc
Three wire flow	!	✓	✓	Check with manufacturer, some MAFs require 12V power yet output a 0-5V signal
Device	✗	✓	✓	AEM 30-4110 UEGO Gauge with 0-5V Output
Existing / OEM Sensors				
Three wire pressure	✗	✓	✓	Manifold pressure, oil/water pressure, etc
Three wire position	✗	✓	✓	Throttle/pedal position, linear potentiometer, etc
Two wire temperature	✗	✓	✓	Intake, coolant/oil temperature, etc
Three wire flow	✗	✓	✓	0-5V voltage-style MAF sensor
Device	✗	✓	✓	AEM 30-4110 UEGO Gauge with 0-5V Output

✓ = Connect

✗ = Don't connect

CAN Output

The measured voltage will be output via CAN and will have to be scaled to the desired units (e.g. temperature, pressure, percentage, etc) in the receiving device. A thermistor's voltage/resistance varies non-linearly with temperature and thus the receiving device will likely require a look-up table to properly log or display temperature. Most non-temperature sensors require a simpler linear scaling. The AEM CD series of dashes have both of these capabilities; please refer to the appropriate documentation.

Tachometer Input

This input is suitable for measuring engine speed from a variety of sources such as an ignition coil's negative (-) terminal or an ignition box/driver's 'tachometer' output. If your vehicle is equipped with an aftermarket high-output or multi-strike ignition system, do ***not*** connect this input to the ignition coil. Instead, use the dedicated tachometer output wire from your ignition system. "Flying Magnet" or VR style sensors should ***not*** be connected to the tachometer input.

CAN Output

The measured frequency will be output in Hertz via CAN and will have to be scaled to engine speed (RPM) in the receiving device. The AEM CD series of dashes have this capability; please refer to the appropriate documentation.

Fuel Level Sensor Input

This input is suitable for connection to a resistive fuel level sensor. The output of these sensors typically varies from slightly above 0 Ohms to a maximum of 250 Ohms. It is important that the AEM CAN Sensor Module is the only device connected to the fuel level sensor. Tapping on to a sensor that is already connected to an OEM ECU (or similar) will result in inaccurate readings.

CAN Output

The measured resistance will be output via CAN and will have to be scaled (typically linear) to fuel level (or percentage) in the receiving device. The AEM CD series of dashes have this capability; please refer to the appropriate documentation.

Note: The CAN output value, in Ohms, may appear to be slow to respond to input sensor signal changes. This is as-intended since this input is heavily filtered to account for fuel level slosh.

Connector and Accessory Part Numbers

The following is a list of compatible AEMnet accessories as well as part numbers for the main Module connector and terminals.

AEM PN	Description	AEM PN	Description
35-2633	CONNECTOR KIT, 12-WY, DTM PLUG	35-2624	DTM-Style 4-Way Plug Connector Kit. Includes Plug, Wedge Lock & 5 Female Pin
		35-2625	DTM-Style 4-Way Receptacle Connector Kit. Includes Receptacle, Wedge Lock & 5 Male P
		35-2626	DTM-Style 4-Way Connector Kit. Includes Plug, Receptacle, 2 Wedge Locks 5 Female Pins & 5 Male Pins
		30-3606	AEMnet CAN bus Extension Cable, 2 ft
		30-3607	AEMnet CAN bus Extension Cable, 5 ft
		30-3608	AEMnet CAN bus Extension Cable, 10 ft
		35-3440-F	AEMnet Female Termination Plug
		35-3440-M	AEMnet Male Termination Plug

Compatible AEM Sensors

The following is a list of compatible AEM sensors as well as the type of input class and pull-up value it should be connected to.

AEM PN	Description	Input Type	Pull-Up Value (Ohms)
30-2010	Air Temp Sensor Kit. 3/8"NPT	Analog	2200
30-2011	Water Temp Sensor Kit. 3/8"NPT	Analog	2200
30-2012	Water Temp Sensor Kit. 1/8"NPT	Analog	2200
30-2013	Fluid Temperature Sensor DTM-Style Kit	Analog	2200
30-2014	Air Temp Sensor DTM-Style Kit	Analog	2200
30-2064	Exhaust Back Pressure Sensor Install Kit	Analog	100,000
30-2130-7	100 PSIA or 7 Bar Stainless Sensor Kit. Stainless Steel Sensor Body	Analog	100,000
30-2130-15	15 PSIA or 1 Bar Stainless Sensor Kit. Stainless Steel Sensor Body	Analog	100,000
30-2130-30	30 PSIA or 2 Bar Stainless Sensor Kit. Stainless Steel Sensor Body	Analog	100,000
30-2130-50	50 PSIA or 3.5 Bar Stainless Sensor Kit. Stainless Steel Sensor Body	Analog	100,000
30-2130-75	75 PSIA or 5 Bar Stainless Sensor Kit. Stainless Steel Sensor Body	Analog	100,000
30-2130-100	100 PSIG Stainless Sensor Kit. Stainless Steel Sensor Body	Analog	100,000
30-2130-150	150 PSIG Stainless Sensor Kit. Stainless Steel Sensor Body	Analog	100,000
30-2130-500	500 PSIG Stainless Sensor Kit. Stainless Steel Sensor Body	Analog	100,000
30-2130-1000	1000 PSIG Stainless Sensor Kit. Stainless Steel Sensor Body	Analog	100,000
30-2130-2000	2000 PSIG Stainless Sensor Kit. Stainless Steel Sensor Body	Analog	100,000
30-2131-15G	15 PSIG Brass Sensor Kit. Brass Sensor Body	Analog	100,000
30-2131-30	30 PSIA or 2 Bar Brass Sensor Kit. Brass Sensor Body	Analog	100,000
30-2131-50	50 PSIA or 3.5 Bar Brass Sensor Kit. Brass Sensor Body	Analog	100,000
30-2131-75	75 PSIA or 5 Bar Brass Sensor Kit. Brass Sensor Body	Analog	100,000
30-2131-100	100 PSIG Brass Sensor Kit. Brass Sensor Body	Analog	100,000
30-2131-150	150 PSIG Brass Sensor Kit. Brass Sensor Body	Analog	100,000

Specifications

Dimensions	width	2.1 / 55	in / mm
	length	2.1 / 55	in / mm
	height	1.3 / 34	in / mm
	mass	1.2 / 32	oz / g
Supply Voltage	min	7	VDC
	max	18	VDC
Supply Current (13.8V)	nominal	165	mA
Operating Temperature	min	-4 / -20	degF / degC
	max (16V Supply)	185 / 85	degF / degC
5V Sensor Supply	Current	250	mA
Analog Inputs 1 - 2	Range	0 - 65535	Ohm
	Resolution	1 (12-bit)	Ohm
	Pull-up (5V)	2,200	Ohm
	CAN Transmit Rate	100	Hz
Analog Inputs 3 - 4	Range	0 - 5	VDC
	Resolution	0.001 (12-bit)	VDC
	Pull-up (5V)	100,000	Ohm
	CAN Transmit Rate	100	Hz
Fuel Level Input	Range	0 - 250	Ohm
	Resolution	1 (12-bit)	Ohm
	Pull-up	5	VDC
	CAN Transmit Rate	50	Hz
Tachometer Input	Range	0 - 1500	Hz
	Resolution	1	Hz
	Pull-up	12	VDC
	Minimum Trigger Voltage	3	VDC
	Maximum Voltage (Sustained)	18	VDC
	CAN Transmit Rate	50	Hz

FAQ / Troubleshooting

My CAN Sensor Module doesn't seem to be outputting anything.

Confirm that your CAN bus is properly terminated and that all nodes are configured for the right bus speed. In addition, any receiving devices/nodes must be specifically configured to receive as the Module is configured to transmit; specifically, the CAN ID, bus speed, and number of ID bits.

Can I use the CAN Sensor Module with my AEM AQ-1, AEM CAN Gauge, or AEM ECU?

No, the CAN Sensor Module is only compatible with the CD-series dash displays and other third-party devices at this time.

Where can I find AEM .dbc files?

AEM dbc files are available via the AEM Forum and within the AEM CD-series dash display software installer. Please visit www.aemelectronics.com for more information and downloads.

Can I connect more than one 6 Channel CAN Sensor Module on one CAN bus?

No, this is not possible. Please use the AEM 22 Channel CAN Sensor Module if you need more inputs.

For support, contact AEM Technical Support at 1-800-423-0046 or gentech@aemelectronics.com.

AEMnet (CAN Bus) Output

WHITE WIRE = AEMnet+ / CANH

GREEN WIRE = AEMnet- / CANL

Bus Termination

All AEMnet/CAN networks must be terminated to have an equivalent of approximately 60 Ohms of resistance. Generally, this means a 120 Ohm resistor connected in parallel to AEMnet+/AEMnet- (or CANH/CANL) at both physical ends of the bus run.

CAN DBC definition files are available at

www.aemelectronics.com

bit rate	500	kb/sec
format	29	bit ID
terminating resistor	None	
endianness	big / Motorola	
DLC	8	

0x0000B600 at 100Hz

Byte	Label	Data Type	Scaling	Offset	Range
0	Analog1	16 bit unsigned	1 Ohm/bit	0	0 to 65535 Ohm
1					
2	Analog2	16 bit unsigned	1 Ohm/bit	0	0 to 65535 Ohm
3					
4	Analog3	16 bit unsigned	0.001 V/bit	0	0 to 65.535 V
5					
6	Analog4	16 bit unsigned	0.001 V/bit	0	0 to 65.535 V
7					

0x0000B601 at 50Hz

Byte	Label	Data Type	Scaling	Offset	Range
0	Tacho	16 bit unsigned	0.1 Hz/bit	0	0 to 6553.5 Hz
1					
2	n/a	n/a	n/a	n/a	n/a
3					
4	n/a	n/a	n/a	n/a	n/a
5					
6	FuelLevel	8 bit unsigned	1 Ohm/bit	0	0 to 255 Ohm
7	Battery Voltage	8 bit unsigned	0.1 V/bit	0	0 to 25.5 V

22 Channel CAN Sensor Module to Dash

Kit Contents

The AEM 22 Channel CAN Sensor Module enables a user to put analog, digital, and frequency signals on to an AEMnet or CAN bus. The Sensor Module accommodates a wide variety of sensors and is housed in a sealed IP65 weather-resistant enclosure. Sturdy construction, protected inputs, and simple configuration make this the perfect entry point to get everything required to use an AEM CD-series dash on a carbureted or EFI vehicle. The Sensor Module supports the Bosch CAN 2.0b standard with flexible CAN configuration jumpers making it compatible with many third-party devices. Note: The only AEMnet devices that are compatible with the CAN Sensor Module are the CD-series dash displays.

Features

- Four (4) dedicated 0-5V analog inputs
- Four (4) user-configurable analog inputs, (jumper selectable; 0-5V, thermistor, or RTD)
- Four (4) temperature (thermistor) inputs
- One (1) dedicated fuel level input (0 to 250 Ohm range)

PN	QTY	Description
35-2212	1	MODULE, 22 CHANNEL CAN SENSOR MODL
10-2212	1	INST, MODULE, 22 CHANNEL CAN SENSOI MODULE

- Six (6) digital inputs (frequency, duty cycle or simple switch)
- One (1) tachometer/coil input
- Two (2) VR ("magnetic") pair frequency inputs (crank, wheel or drive shaft speeds)
- Jumper selectable CAN bus speeds: 250k, 500k, 1M
- Jumper selectable terminating resistor
- Jumper selectable header length, 11 bit or 29 bit
- Jumper selectable base address, two units can be on the same bus
- IP65 Enclosure - "dust tight" and protected against water spray
- Protected inputs

36-2212	1	HARNESS, MODULE, 22 CHANNEL CAN SENSOR MODULE
4-0126	12	WIRE TERM, 22 AWG YELLOW
4-0127	3	WIRE TERM, 22 AWG RED
4-0128	5	WIRE TERM, 22 AWG BLK
4-0129	6	WIRE TERM, 22 AWG TAN
4-0130	6	WIRE TERM, 22 AWG WHT
4-2069	10	TERMINAL, F, MICRO-PACK 20-22 AWG
4-3027	10	SEAL, BLUE, MICRO-PACK 100W

Installation

Mechanical

The Sensor Module may be mounted within the vehicle using hook-and-loop fastener or bolted to a suitable structure; a mounting/drill diagram is provided below. The module is weather-resistant (IP65) but is preferably mounted in a cool, dry area such as the driver compartment.

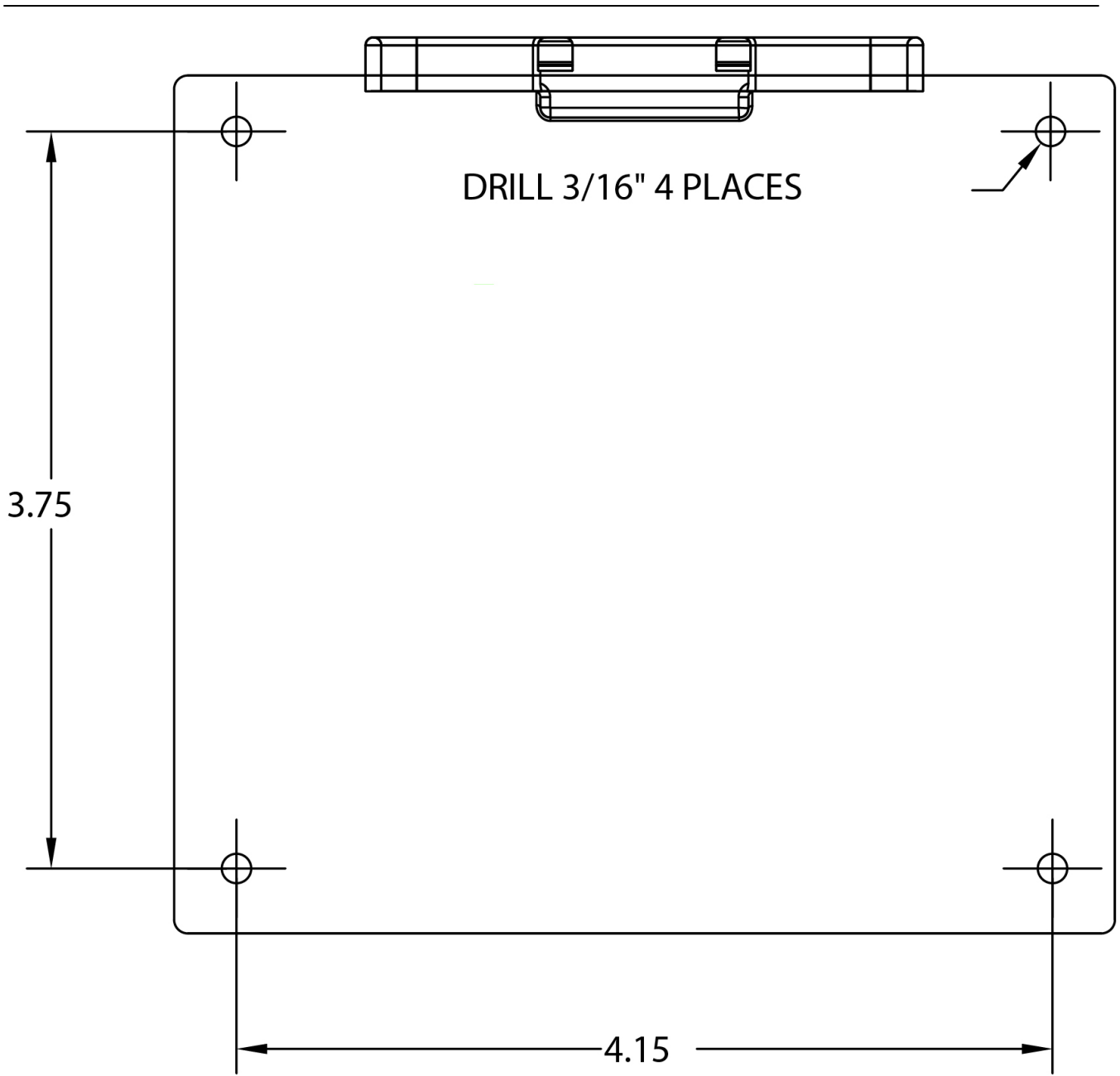

IMAGE NOT TO SCALE

Electrical

The supplied 36-2212 harness comes with a pre-terminated AEMnet spur suitable for powering the module and providing AEMnet/CAN connectivity. In addition, pre-terminated lengths of various color wire are supplied for connection to sensors. The harness connector is a multi-piece assembly which has a clear plastic retainer that must be removed prior to inserting the crimped leads into the assembly. Please see instructions later in this manual.

Sensor Wiring

- The Sensor Module should only be powered through the dedicated power and power ground pins, ***not*** sensor ground
- Every connected sensor should be connected to one of the dedicated *sensor* ground pins to ensure accurate readings
- Do not connect the Module's 5V sensor power to anything *other than* dedicated sensors that require 5V power, e.g. pressure sensors
- Route wiring away from sources of noise such as alternators, ignition components, or other high power/frequency wiring
- Shielded wire is suggested to reduce the susceptibility of noise; the shield should only be grounded/drained on one end of the wiring harness
- CAN wiring should utilize twisted pairs (> 1 TPI); shielding is recommended
- This module is **not** compatible with K-type thermocouples (**unless a K-type amplifier is used**); RTD-style EGT sensors **are** compatible, e.g. AEM PN 30-2050
- The Sensor Module's sensor ground should be at the same level as the sensor ground of any "tapped" sensors, i.e. existing/OEM sensors that are connected to an external ECU/device
- **The device pinout section includes a Suggested Interface column. This may make integration with an AEM Dash easier as sample layouts will be provided that follow these guidelines.**

System Schematic

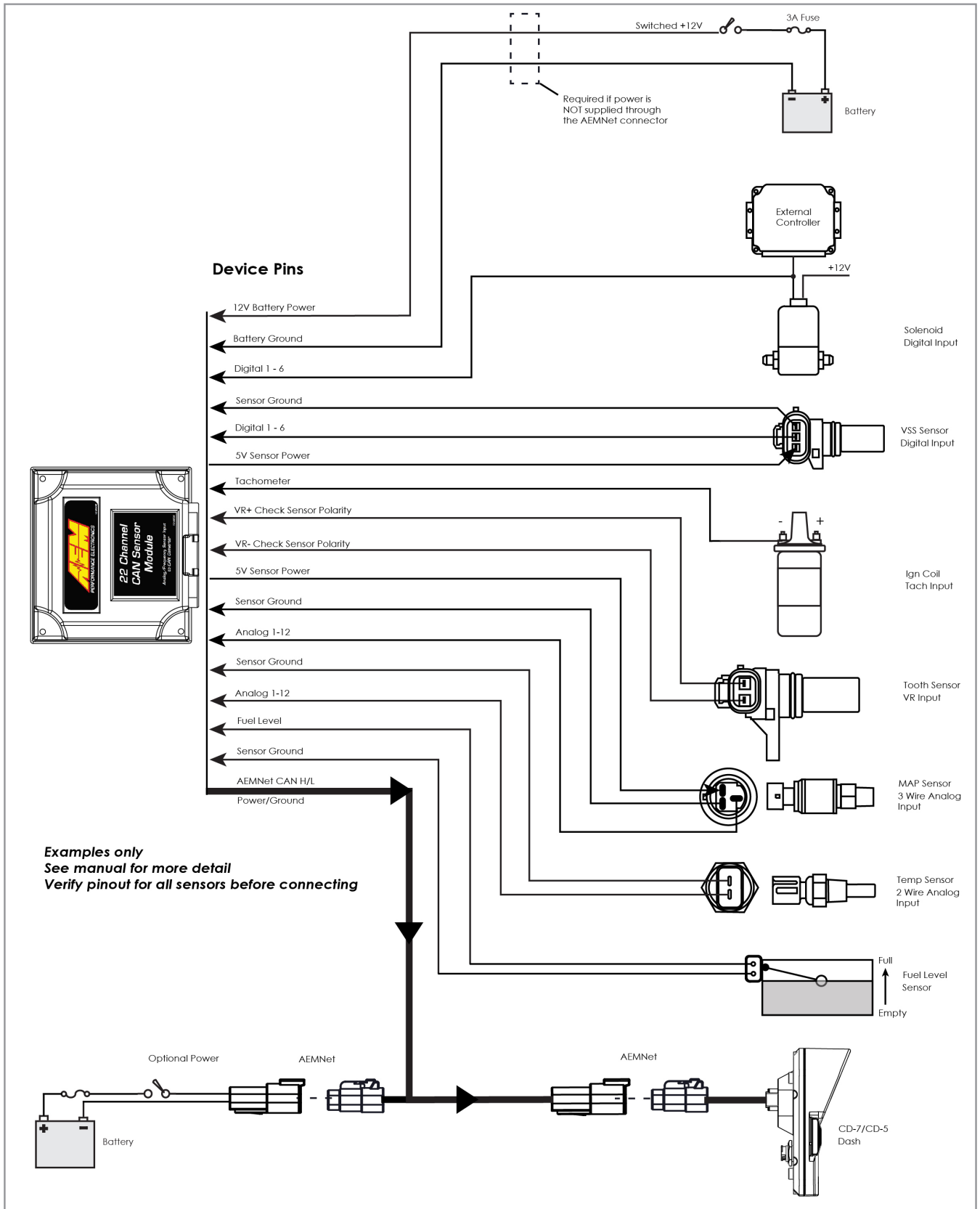

Drawing: SYSTEM SCHEMATIC

30-2212
PRODUCT: 22 CH CAN Sensor Module

Date: 12/7/2017

Rev:

Engineer:

Device Pinout

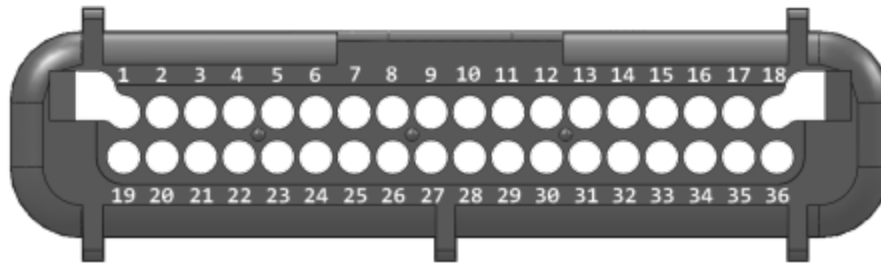

Pin	Name	Function	Suggested Interface
1	12V Battery Power (+)	Primary ignition/battery power input	Fused Ignition Switch
2	AEMnet+ / CANH	AEMnet / CAN bus output	AEMNet +/High (White)
3	VR1 Positive (+)	VR / Magnetic Sensor input (Crank, wheel, or drive shaft speeds)	Driven Wheel Speed VR
4	VR1 Negative (-)	VR / Magnetic Sensor input (Crank, wheel, or drive shaft speeds)	
5	Fuel Level	0 - 250 Ohm fuel level sensor input	Fuel Level Sensor
6	Tachometer	Engine speed input (negative coil terminal) 12V pull-up	Tach signal/Coil negative
7	Sensor Ground	Dedicated sensor ground	Sensor Ground
8	Sensor Ground	Dedicated sensor ground	Sensor Ground
9	5V Sensor Power	5V sensor reference power output	5v Reference Voltage
10	5V Sensor Power	5V sensor reference power output	5v Reference Voltage
11	Sensor Ground	Dedicated sensor ground	Sensor Ground
12	Digital 1	Frequency, duty cycle %, and switch input / Active low, 12V pull-up	Driveshaft Speed
13	Digital 2	Frequency, duty cycle %, and switch input / Active low, 12V pull-up	Nitrous Arm Switch
14	Digital 3	Frequency, duty cycle %, and switch input / Active low, 12V pull-up	Clutch Switch
15	Digital 4	Frequency, duty cycle %, and switch input / Active low, 12V pull-up	Brake Switch
16	Digital 5	Frequency, duty cycle %, and switch input / Active low, 12V pull-up	Trans Brake
17	Digital 6	Frequency, duty cycle %, and switch input / Active low, 12V pull-up	Spare
18	Sensor Ground	Dedicated sensor ground	Sensor Ground
19	Battery Ground (-)	Primary ignition/battery ground input	Battery/chassis ground
20	AEMnet- / CANL	AEMnet / CAN bus Output	AEMNet -/Low (Green)
21	VR2 Positive (+)	VR / Magnetic Sensor input (Crank, wheel, or drive shaft speeds)	Non-Driven Wheel Speed VR
22	VR2 Negative (-)	VR / Magnetic Sensor input (Crank, wheel, or drive shaft speeds)	
23	Analog 1	0-5V Analog input, 100k Ohm 5V pull-up	TPS / Throttle Position Sensor
24	Analog 2	0-5V Analog input, 100k Ohm 5V pull-up	Manifold Pressure Sensor
25	Analog 3	0-5V Analog input, 100k Ohm 5V pull-up	Fuel Pressure Sensor
26	Analog 4	0-5V Analog input, 100k Ohm 5V pull-up	Oil Pressure Sensor
27	Analog 5	0-5V, Thermistor, RTD input, jumper selectable (470, 2200, 100k) 5V pull-up	Air/Fuel Ratio Analog Bank 1
28	Analog 6	0-5V, Thermistor, RTD input, jumper selectable (470, 2200, 100k) 5V pull-up	Air/Fuel Ratio Analog Bank 2

29	Analog 7	0-5V, Thermistor, RTD input, jumper selectable (470, 2200, 100k) 5V pull-up	Nitrous Pressure Sensor
30	Analog 8	0-5V, Thermistor, RTD input, jumper selectable (470, 2200, 100k) 5V pull-up	Brake Pressure
31	Analog 9	Temperature / thermistor input, 2200 Ohm 5V pull-up	Coolant Temperature Sensor
32	Analog 10	Temperature / thermistor input, 2200 Ohm 5V pull-up	Intake Air Temperature Sensor
33	Analog 11	Temperature / thermistor input, 2200 Ohm 5V pull-up	Oil Temperature Sensor
34	Analog 12	Temperature / thermistor input, 2200 Ohm 5V pull-up	Transmission Temp
35	Sensor Ground	Dedicated sensor ground	Sensor Ground to temp sensors
36	5V Sensor Power	5V sensor reference power output	5v Reference Voltage

Analog Inputs 1 - 4

These inputs have a 100kOhm 5V pull-up resistor and are suitable to measure voltage signals from 0-5V sensors or devices; either sensors that are being added to a vehicle or pre-existing (or OEM) sensors. Pre-existing/OEM sensors are presumed to be already connected to a factory ECU or logging device which will require different wiring considerations. Please refer to the table below for connection examples.

New / Added Sensors	5V Sensor Power	Sensor Signal	Sensor Ground	Examples
Three wire pressure	✓	✓	✓	Manifold pressure, oil/water pressure, etc
Three wire position	✓	✓	✓	Throttle/pedal position, linear potentiometer, etc
Three wire flow	!	✓	✓	Check with manufacturer, some MAFs require 12V power yet output a 0-5V signal
Device	✗	✓	✓	AEM 30-4110 UEGO Gauge with 0-5V Output
Existing / OEM Sensors				
Three wire pressure	✗	✓	✓	Manifold pressure, oil/water pressure, etc
Three wire position	✗	✓	✓	Throttle/pedal position, linear potentiometer, etc
Two wire temperature	✗	✓	✓	Intake, coolant/oil temperature, etc
Three wire flow	✗	✓	✓	0-5V voltage-style MAF sensor
Device	✗	✓	✓	AEM 30-4110 UEGO Gauge with 0-5V Output

✓ =Connect

✗ =Don't connect

CAN Output

The measured voltage will be output via CAN and will have to be scaled to the desired units (e.g. temperature, pressure, percentage, etc) in the receiving device. A thermistor's voltage/resistance varies non-linearly with temperature and thus the receiving device will likely require a look-up table to properly log or display temperature. Most non-temperature sensors require a simpler linear scaling. The AEM CD series of dashes have both of these capabilities; please refer to the appropriate documentation.

Analog Inputs 5 - 8

These inputs have a jumper-selectable 5V pull-up resistor and are suitable for a variety of sensors, either sensors that are being added to a vehicle or pre-existing (or OEM) sensors. Pre-existing/OEM sensors are presumed to be already connected to a factory ECU or logging device which will require different wiring and jumper setting considerations. Please refer to the table below for connection examples.

New / Added Sensors	Jumper/Pull-up	5V Sensor Power	Sensor Signal	Sensor Ground	Notes
Three wire pressure	100k	✓	✓	✓	Manifold pressure, oil/water pressure, etc
Three wire position	100k	✓	✓	✓	Throttle/pedal position, linear potentiometer, etc
Three wire flow	100k	!	✓	✓	Check with manufacturer, some MAFs require 12V power yet output a 0-5V signal
Two wire temperature	2200	✗	✓	✓	Intake, coolant/oil temperature, etc (thermistor only)
Two wire RTD EGT	470	✗	✓	✓	Exhaust Gas Temperature (RTD Only)
Device	100k	✗	✓	✓	AEM 30-4110 UEGO Gauge with 0-5V Output
Existing / OEM Sensors					
Three wire pressure	100k	✗	✓	✓	Manifold pressure, oil/water pressure, etc
Three wire position	100k	✗	✓	✓	Throttle/pedal position, linear potentiometer, etc
Two wire temperature	100k	✗	✓	✓	Intake, coolant/oil temperature, etc
Three wire flow	100k	✗	✓	✓	0-5V voltage-style MAF sensor
Device	100k	✗	✓	✓	AEM 30-4110 UEGO Gauge with 0-5V Output

✓ = Connect

✗ = Don't connect

! = Read Notes

CAN Output

The measured voltage and resistance will be output via CAN and will have to be scaled to the desired units (e.g. temperature, pressure, percentage, etc) in the receiving device. A thermistor's voltage/resistance varies non-linearly with temperature and thus the receiving device will likely require a look-up table to properly log or display temperature. Most non-temperature sensors require a simpler linear scaling. The AEM CD series of dashes have both of these capabilities; please refer to the appropriate documentation.

Note: The resistance value output via CAN is not valid when the pull-up jumper is in the "100kOhm" position. Please refer to the voltage output.

Analog Inputs 9 - 12

These inputs have a 2200 Ohm 5V pull-up resistor and are suitable for two-wire thermistor temperature sensors. It is not recommended to connect these inputs to pre-existing/OEM sensors that are already connected to a factory ECU or logging device. Please refer to the table below for connection examples.

New / Added Sensors	5V Sensor Power	Sensor Signal	Sensor Ground	Examples
Two wire temperature	✗	✓	✓	Intake, coolant/oil temperature, etc

✓ = Connect

✗ = Don't connect

! = Read Notes

CAN Output

The measured resistance will be output via CAN and will have to be scaled to temperature in the receiving device. A thermistor's resistance varies non-linearly with temperature and thus the receiving device will likely require a look-up table to properly log or display temperature. The AEM CD series of dashes have this capability; please refer to the appropriate documentation.

VR (Variable Reluctance) Inputs 1 -2

These inputs are suitable for connection to two-wire VR (variable reluctance) or "magnetic" style speed sensors. Each input is composed of a pair of wires, positive (+) and negative (-), which must be connected to the sensor's respective terminals. You may connect the Sensor Module to existing/OEM sensors or new sensors that have been added to the vehicle. Common uses for these inputs would be for use with wheelspeed or driveshaft speed sensors.

Input Sensitivity / Jumper Selection

The "VR Sense" jumper configures the sensitivity, high or low, for these inputs. The default/recommended position is "HI" which should work well for most situations. The "LOW" setting may be tried if there are low-speed signal dropouts. Please refer to the section entitled *Jumper Configuration* for more information on how to change jumper settings.

CAN Output

The measured frequency will be output in Hertz via CAN and will have to be scaled to speed (RPM, MPH, KPH, etc) in the receiving device. The AEM CD series of dashes have this capability; please refer to the appropriate documentation.

Tachometer Input

This input is suitable for measuring engine speed from a variety of sources such as an ignition coil's negative (-) terminal or an ignition box/driver's 'tachometer' output. If your vehicle is equipped with an aftermarket high-output or multi-strike ignition system, do ***not*** connect this input to the ignition coil. Instead, use the dedicated tachometer output wire from your ignition system. "Flying Magnet" or VR style sensors should be connected to one of the VR inputs and ***not*** the tachometer input.

CAN Output

The measured frequency will be output in Hertz via CAN and will have to be scaled to engine speed (RPM) in the receiving device. The AEM CD series of dashes have this capability; please refer to the appropriate documentation.

Fuel Level Sensor Input

This input is suitable for connection to a resistive fuel level sensor. The output of these sensors typically varies from slightly above 0 Ohms to a maximum of 240 Ohms. It is important that the AEM CAN Sensor Module is the only device connected to the fuel level sensor. Tapping on to a sensor that is already connected to an OEM ECU (or similar) will result in inaccurate readings.

CAN Output

The measured resistance will be output via CAN and will have to be scaled (typically linear) to fuel level (or percentage) in the receiving device. The AEM CD series of dashes have this capability; please refer to the appropriate documentation.

Note: The CAN output value, in Ohms, may appear to be slow to respond to input sensor signal changes. This is as-intended since this input is heavily filtered to account for fuel level slosh.

Digital Inputs 1 - 6

These inputs are suitable for measuring the frequency, duty cycle, and state of 0 - 12V signals. Each input measures and outputs all three parameters without further configuration. Examples of common digital sensor signals and typical applications are listed below.

Digital signal examples	Frequency (Hz)	Duty Cycle (%)	State (On/Off)	Notes
Vehicle Speed Sensor (VSS)	✓			VSS frequency is proportional to vehicle speed.
Injector*		✓		Injector duty cycle is proportional to amount of fuel used**

Boost Solenoid*		✓		Boost solenoid duty cycle is proportional to boost/MAP
Transmission Solenoid*		✓		Solenoid duty cycle is proportional to line pressure
Clutch Switch / Trans Brake*			✓	The output will change to '1' or 'ON' when grounded
MAF Sensor	✓			Frequency is proportional to airflow
Flex Fuel Sensor	✓	✓		Frequency = Ethanol Content Duty Cycle = Fuel Temperature

* Duty Cycle and State are active low inputs ** The Sensor Module does support OEM ECU multi-pulse signals

Note: These inputs are flyback protected but only suitable for low-energy signals. Do not connect these inputs to ignition coils or VR sensors. Please refer to the device specifications further in this manual.

CAN Output

Each input will output the following three parameters:

Frequency (Hz) - The reciprocal of the period of a signal where the period is the amount of time between two rising (or falling) edges.

Duty Cycle (%) [Active Low] - The fraction of one period in which the signal is low.

State [Active Low] - This output will be "1" or "ON" when the input is grounded and "0" or "OFF" when disconnected or above the threshold voltage of ~7.5V. Note that this output is de-bounced and not suitable for fast changing signals (> ~1Hz). It is best suited for mechanical driver-operated switches with two positions.

Jumper Configuration

Several configuration jumpers are located beneath the rear cover of the Sensor Module. The rear cover may be removed by unscrewing the four external screws to change the jumper positions if needed. The Sensor Module is delivered from the factory in the most common configuration suitable for use with AEMnet (and other) devices; changing the jumper positions is not typically necessary.

CAN TERM - A maximum of two termination resistors should be active per CAN bus installation. Please refer to the documentation for the other devices on your network.

VR SENSE - The default/recommended position is "HI" which should work well for most situations. The "LOW" setting may be tried if there are low-speed signal dropouts.

ANx PULLUP - Please refer to the 'Analog Inputs 5 - 8' section of this manual.

CAN SPEED - The default position of 500k is correct for AEMnet. Please refer to the manufacturer's documentation if you are using any third-party devices.

CAN BITS - The default position of 29 is correct for AEMnet. Please refer to the manufacturer's documentation if you are using any third-party devices.

CAN ID - The default position of 1 is correct if there is only a single AEM CAN Sensor Module installed on your network. If you are using two Sensor Modules, the first unit must be set to '1' and the second to '2'. The second Sensor Module on a network with two modules will transmit at half the rate of the first to prevent overloading the bus.

	No Jumper	1 - 2	2 - 3	Description
CAN TERM	OFF	ON*		Sets 120 Ohm CAN termination resistor
VR SENSE		HI*	LOW	VR inputs 1-2 trigger sensitivity
AN5 PULLUP	100k*	470	2200	Analog input 5 pull-up resistor (Ohms)
AN6 PULLUP	100k*	470	2200	Analog input 6 pull-up resistor (Ohms)
AN7 PULLUP	100k*	470	2200	Analog input 7 pull-up resistor (Ohms)
AN8 PULLUP	100k*	470	2200	Analog input 8 pull-up resistor (Ohms)
CAN SPEED	250k	500k*	1M	CAN bus speed (kbit/sec)
CAN BITS	29*	11		CAN bus ID length (bits)
CAN ID	1*	2		First or second Sensor module on bus

Jumper Position (* = Default Position)

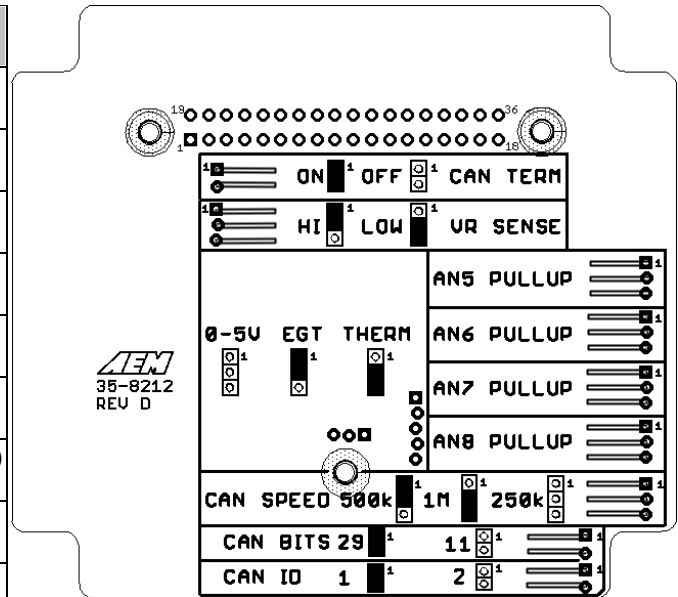

Inserting / Removing Pins

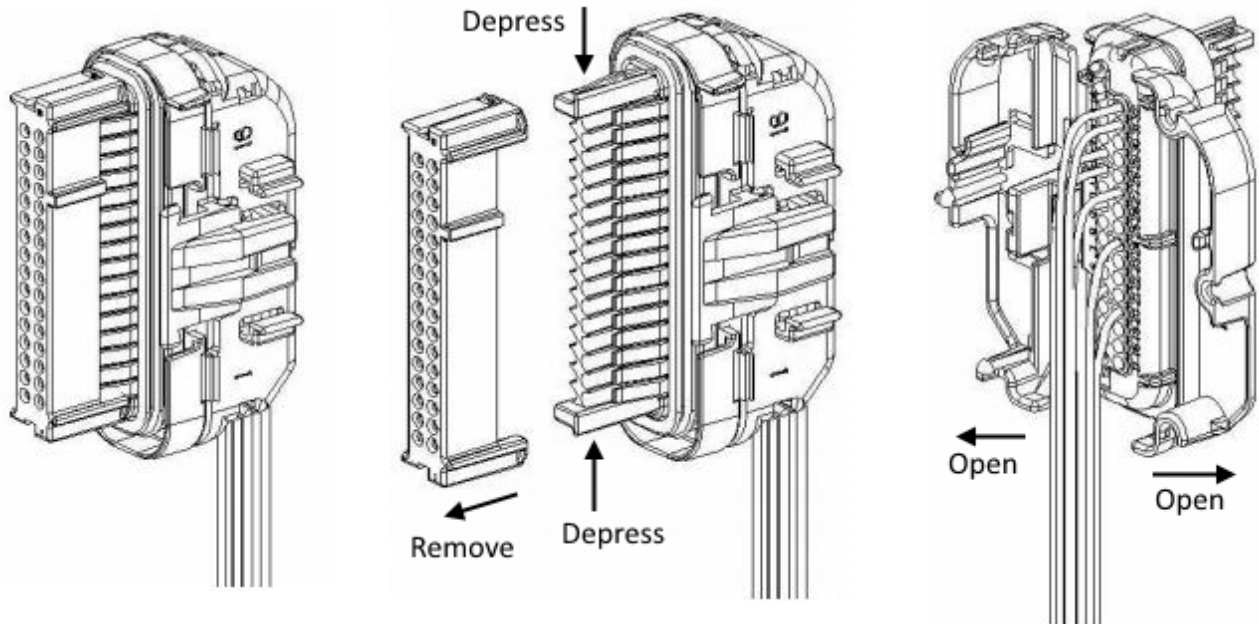

The clear retainer will have to be removed to insert/remove pins

Depress the two black tabs and slide retainer off

Unsnap and open the grey wings to insert new pins

Note that 10 blue seals are included with the kit. For terminal locations that aren't being used, these must be inserted to seal out water or other contaminants.

Connector and Accessory Part Numbers

The following is a list of compatible AEMnet accessories as well as part numbers for the main Module connector and terminals.

Delphi PN	Description	AEM PN	Description
-----------	-------------	--------	-------------

12110487	36P Female 100W Series (Black)	35-2624	DTM-Style 4-Way Plug Connector Kit. Includes Plug, Wedge Lock & 5 Female Pin
12110490	Strain Relief Lock (Grey)	35-2625	DTM-Style 4-Way Receptacle Connector Kit Includes Receptacle, Wedge Lock & 5 Male P
12110488-B	36P Retainer Lock (Clear)	35-2626	DTM-Style 4-Way Connector Kit. Includes Plug, Receptable, 2 Wedge Locks 5 Female Pins & 5 Male Pins
12110489-B	36P Seal (Green)	30-3606	AEMnet CAN bus Extension Cable, 2 ft
12084913	Terminal (20-22 AWG)	30-3607	AEMnet CAN bus Extension Cable, 5 ft
15356825	Cavity Sealing Plugs (Blue)	30-3608	AEMnet CAN bus Extension Cable, 10 ft
		35-3440-F	AEMnet Female Termination Plug
		35-3440-M	AEMnet Male Termination Plug

Compatible AEM Sensors

The following is a list of compatible AEM sensors as well as the type of input class and pull-up value it should be connected to.

AEM PN	Description	Input Type	Pull-Up Value (Ohms)
30-2010	Air Temp Sensor Kit. 3/8"NPT	Analog	2200
30-2011	Water Temp Sensor Kit. 3/8"NPT	Analog	2200
30-2012	Water Temp Sensor Kit. 1/8"NPT	Analog	2200
30-2013	Fluid Temperature Sensor DTM-Style Kit	Analog	2200
30-2014	Air Temp Sensor DTM-Style Kit	Analog	2200
30-2050	RTD Temperature Sensor Kit. Inconel Body. M14 X 6H	Analog	470
30-2064	Exhaust Back Pressure Sensor Install Kit	Analog	100,000
30-2130-7	100 PSIA or 7 Bar Stainless Sensor Kit. Stainless Steel Sensor Body	Analog	100,000
30-2130-15	15 PSIA or 1 Bar Stainless Sensor Kit. Stainless Steel Sensor Body	Analog	100,000
30-2130-30	30 PSIA or 2 Bar Stainless Sensor Kit. Stainless Steel Sensor Body	Analog	100,000
30-2130-50	50 PSIA or 3.5 Bar Stainless Sensor Kit. Stainless Steel Sensor Body	Analog	100,000
30-2130-75	75 PSIA or 5 Bar Stainless Sensor Kit. Stainless Steel Sensor Body	Analog	100,000
30-2130-100	100 PSIG Stainless Sensor Kit. Stainless Steel Sensor Body	Analog	100,000
30-2130-150	150 PSIG Stainless Sensor Kit. Stainless Steel Sensor Body	Analog	100,000
30-2130-500	500 PSIG Stainless Sensor Kit. Stainless Steel Sensor Body	Analog	100,000
30-2130-1000	1000 PSIG Stainless Sensor Kit. Stainless Steel Sensor Body	Analog	100,000
30-2130-2000	2000 PSIG Stainless Sensor Kit. Stainless Steel Sensor Body	Analog	100,000
30-2131-15G	15 PSIG Brass Sensor Kit. Brass Sensor Body	Analog	100,000
30-2131-30	30 PSIA or 2 Bar Brass Sensor Kit. Brass Sensor Body	Analog	100,000
30-2131-50	50 PSIA or 3.5 Bar Brass Sensor Kit. Brass Sensor Body	Analog	100,000
30-2131-75	75 PSIA or 5 Bar Brass Sensor Kit. Brass Sensor Body	Analog	100,000
30-2131-100	100 PSIG Brass Sensor Kit. Brass Sensor Body	Analog	100,000
30-2131-150	150 PSIG Brass Sensor Kit. Brass Sensor Body	Analog	100,000
30-2200	Ethanol Content Flex Fuel Sensor Kit (Barbed)	Digital	N/A

Specifications

Dimensions	width	4.7 / 120	in / mm
	length	4.3 / 110	in / mm
	height	1.4 / 36	in / mm
	mass	6.3 / 180	oz / g
Supply Voltage	min	7	VDC
	max	18	VDC
Supply Current (13.8V)	nominal	165	mA
Operating Temperature	min	-4 / -20	degF / degC
	max (16V Supply)	185 / 85	degF / degC
5V Sensor Supply	Current	250	mA
Analog Inputs 1 - 4	Range	0 - 5	VDC
	Resolution	0.001 (12-bit)	VDC
	Pull-up (5V)	100,000	Ohm
	CAN Transmit Rate (Unit 1)	100	Hz
	CAN Transmit Rate (Unit 2)	50	Hz
Analog Inputs 5 - 8	Range	0 - 5	VDC
	Resolution	0.001 (12-bit)	VDC
	Range	0 - 65535	Ohm
	Resolution	1 (12-bit)	Ohm
	Selectable Pull-up (5V)	470, 2200, or 100000	Ohm
	CAN Transmit Rate (Unit 1) [Voltage/ Resistance]	100 / 10	Hz
CAN Transmit Rate (Unit 2) [Voltage / Resistance]	50 / 5	Hz	
Analog Inputs 9 - 12	Range	0 - 65535	Ohm
	Resolution	1 (12-bit)	Ohm
	Pull-up (5V)	2,200	Ohm
	CAN Transmit Rate (Unit 1)	10	Hz
	CAN Transmit Rate (Unit 2)	5	Hz
Fuel Level Input	Range	0 - 255	Ohm
	Resolution	1 (12-bit)	Ohm
	Pull-up	5	VDC
	CAN Transmit Rate (Unit 1)	50	Hz
	CAN Transmit Rate (Unit 2)	25	Hz
VR Inputs 1 - 2	Range	0 - 15000	Hz
	Resolution	1	Hz
	CAN Transmit Rate (Unit 1)	50	Hz
	CAN Transmit Rate (Unit 2)	25	Hz
Tachometer Input	Range	0 - 1500	Hz
	Resolution	0.1	Hz
	Pull-up	12	VDC
	Minimum Trigger Voltage	3	VDC
	Maximum Voltage (Sustained)	18	VDC
	CAN Transmit Rate (Unit 1)	50	Hz
	CAN Transmit Rate (Unit 2)	25	Hz
Digital Inputs 1 - 6	Frequency Range	0 - 15000	Hz
	Frequency Resolution	1	Hz
	Duty Cycle Range	0 - 100	%
	Duty Cycle Resolution	1	%
	Minimum Trigger Voltage	7.5	VDC
	Maximum Voltage	18	VDC
	Pull-up	12	VDC

	CAN Transmit Rate (Unit 1)	50	Hz
	CAN Transmit Rate (Unit 2)	25	Hz

FAQ / Troubleshooting

My CAN Sensor Module doesn't seem to be outputting anything.

Confirm that your CAN bus is properly terminated and that all nodes are configured for the right bus speed. In addition, any receiving devices/nodes must be specifically configured to receive as the Module is configured to transmit; specifically, the CAN ID, bus speed, and number of ID bits.

Can I use the CAN Sensor Module with my AEM AQ-1, AEM CAN Gauge, or AEM ECU?

No, the CAN Sensor Module is only compatible with the CD-series dash displays and other third-party devices at this time.

Where can I find AEM .dbc files?

AEM dbc files are available via the AEM Forum and within the AEM CD-series dash display software installer. Please visit www.aemelectronics.com for more information and downloads.

For support, contact AEM Technical Support at 1-800-423-0046 or gentech@aemelectronics.com.

AEMnet (CAN Bus) Output

WHITE WIRE = AEMnet+ / CANH

GREEN WIRE = AEMnet- / CANL

Bus Termination

All AEMnet/CAN networks must be terminated to have an equivalent of approximately 60 Ohms of resistance. Generally, this means a 120 Ohm resistor connected in parallel to AEMnet+/AEMnet- (or CANH/CANL) at both physical ends of the bus run. Select termination via jumper position as suitable for your network.

CAN DBC definition files are available at

www.aemelectronics.com

bit rate	Selectable via Jumper	kb/sec
format	Selectable via Jumper	bit ID
terminating resistor	Selectable via Jumper	
endianness	big / Motorola	
DLC	8	

Unit 1: 0x500(11) / 0x0000B000 (29) at 100Hz

Unit 2: 0x600(11) / 0x0000C000(29) at 50Hz

Byte	Label	Data Type	Scaling	Offset	Range
0	Analog1	16 bit unsigned	0.001 V/bit	0	0 to 65.535 V
1					
2	Analog2	16 bit unsigned	0.001 V/bit	0	0 to 65.535 V
3					
4	Analog3	16 bit unsigned	0.001 V/bit	0	0 to 65.535 V
5					
6	Analog4	16 bit unsigned	0.001 V/bit	0	0 to 65.535 V
7					

Unit 1: 0x501(11) / 0x0000B001 (29) at 100Hz

Unit 2: 0x601(11) / 0x0000C001 (29) at 50Hz

Byte	Label	Data Type	Scaling	Offset	Range
0	Analog5	16 bit unsigned	0.001 V/bit	0	0 to 65.535 V
1					
2	Analog6	16 bit unsigned	0.001 V/bit	0	0 to 65.535 V
3					
4	Analog7	16 bit unsigned	0.001 V/bit	0	0 to 65.535 V
5					
6	Analog8	16 bit unsigned	0.001 V/bit	0	0 to 65.535 V
7					

Unit 1: 0x502(11) / 0x0000B002 (29) at 10Hz

Unit 2: 0x602(11) / 0x0000C002 (29) at 5Hz

Byte	Label	Data Type	Scaling	Offset	Range
0	Analog5Resistance	16 bit unsigned	1 Ohm/bit	0	0 to 65535 Ohm
1					
2	Analog6Resistance	16 bit unsigned	1 Ohm/bit	0	0 to 65535 Ohm

3					
4	Analog7Resistance	16 bit unsigned	1 Ohm/bit	0	0 to 65535 Ohm
5					
6	Analog8Resistance	16 bit unsigned	1 Ohm/bit	0	0 to 65535 Ohm
7					

Unit 1: 0x503(11) / 0x0000B003 (29) at 10Hz Unit 2: 0x603(11) / 0x0000C003 (29) at 5Hz

Byte	Label	Data Type	Scaling	Offset	Range
0	Analog9Resistance	16 bit unsigned	1 Ohm/bit	0	0 to 65535 Ohm
1					
2	Analog10Resistance	16 bit unsigned	1 Ohm/bit	0	0 to 65535 Ohm
3					
4	Analog11Resistance	16 bit unsigned	1 Ohm/bit	0	0 to 65535 Ohm
5					
6	Analog12Resistance	16 bit unsigned	1 Ohm/bit	0	0 to 65535 Ohm
7					

Unit 1: 0x504(11) / 0x0000B004 (29) at 50Hz Unit 2: 0x604(11) / 0x0000C004 (29) at 25Hz

Byte	Label	Data Type	Scaling	Offset	Range
0	VR1	16 bit unsigned	1 Hz/bit	0	0 to 65535 Hz
1					
2	VR2	16 bit unsigned	1 Hz/bit	0	0 to 65535 Hz
3					
4	Tacho	16 bit unsigned	0.1 Hz/bit	0	0 to 6553.5 Hz
5					
6	FuelLevel	8 bit unsigned	1 Ohm/bit	0	0 to 255 Hz
7	Battery Voltage	8 bit unsigned	0.1 V/bit	0	0 to 25.5 V

Unit 1: 0x505(11) / 0x0000B005 (29) at 50Hz Unit 2: 0x605(11) / 0x0000C005 (29) at 25Hz

Byte	Label	Data Type	Scaling	Offset	Range
0	Digital1Frequency	16 bit unsigned	1 Hz/bit	0	0 to 65535 Hz
1					
2	Digital2Frequency	16 bit unsigned	1 Hz/bit	0	0 to 65535 Hz
3					
6	Digital1DutyCycle	8 bit unsigned	1 %/bit	0	0 to 255 %
7	Digital2DutyCycle	8 bit unsigned	1 %/bit	0	0 to 255 %
6	Digital1State	8 bit unsigned	1	0	0 to 255
7	Digital2State	8 bit unsigned	1	0	0 to 255

Unit 1: 0x506(11) / 0x0000B006 (29) at 50Hz Unit 2: 0x606(11) / 0x0000C006 (29) at 25Hz

Byte	Label	Data Type	Scaling	Offset	Range
0	Digital3Frequency	16 bit unsigned	1 Hz/bit	0	0 to 65535 Hz
1					
2	Digital4Frequency	16 bit unsigned	1 Hz/bit	0	0 to 65535 Hz
3					
6	Digital3DutyCycle	8 bit unsigned	1 %/bit	0	0 to 255 %
7	Digital4DutyCycle	8 bit unsigned	1 %/bit	0	0 to 255 %
6	Digital3State	8 bit unsigned	1	0	0 to 255
7	Digital4State	8 bit unsigned	1	0	0 to 255

Unit 1: 0x507(11) / 0x0000B007 (29) at 50Hz Unit 2: 0x607(11) / 0x0000C007 (29) at 25Hz

Byte	Label	Data Type	Scaling	Offset	Range
0	Digital5Frequency	16 bit unsigned	1 Hz/bit	0	0 to 65535 Hz
1					
2	Digital6Frequency	16 bit unsigned	1 Hz/bit	0	0 to 65535 Hz
3					
6	Digital5DutyCycle	8 bit unsigned	1 %/bit	0	0 to 255 %
7	Digital6DutyCycle	8 bit unsigned	1 %/bit	0	0 to 255 %
6	Digital5State	8 bit unsigned	1	0	0 to 255
7	Digital6State	8 bit unsigned	1	0	0 to 255

8 Channel K-Type CAN Module to Dash

Kit Contents

The AEM 8 Channel K-Type CAN Module enables a user to put eight K-type thermocouples on to an AEMnet or CAN bus. K-type thermocouples are suitable for various applications such as exhaust gas temperature (EGT) measurement, pre/post intercooler temperatures, cylinder head temperatures, and more. All measurements are cold junction compensated with a range of -200 to +1372 degC / -328 to +2501 degF. The Module is provided with a four-pin DTM connector to provide CAN, power connectivity, and eight miniature style K-type sockets. The Module supports the Bosch CAN 2.0b standard with flexible CAN configuration jumpers making it compatible with many third-party devices. Note: The only AEMnet devices that are compatible with the CAN Sensor Module are the CD-series dash displays and AEM AQ-1 Data Logger.

Features

- Eight (8) K-Type Cold Junction Compensated Thermocouple Inputs
- AEMnet/CAN Output (Thermocouple and Cold Junction Temperatures)
- -200 to +1372 degC / -328 to +2501 degF
- ±0.15% (Max) Thermocouple Full-Scale Error
- 0.1 degC Resolution
- Open Circuit / Fault Detection
- 'Miniature' Style Thermocouple Sockets
- Jumper selectable CAN bus speeds: 250k, 500k, 1M
- Jumper selectable header length, 11 bit or 29 bit
- Jumper selectable base address, two units can be on the same bus

PN	QTY	Description
35-2224	1	MODULE, CAN K-TYPE MODULE
10-2224	1	INST, 30-2224
4-4083	1	2.0" x 1.5" VELCRO
35-2624	1	4 WAY DTM PLUG KIT

Installation

Mounting

The Module should may be mounted within the vehicle using the supplied hook-and-loop fastener or cable ties. The Module's circuit board has a water-resistance coating applied and thus has some tolerance to a humid or condensing atmosphere, however the thermocouple connectors are **not** sealed so a dry and cool mounting location should be chosen.

Power / AEMnet (CAN)

A four pin Deutsch DTM receptacle is integrated into the Module's enclosure to provides power and AEMnet/CAN connectivity. This allows a straightforward "Plug and Play" installation when adding to an existing AEMnet network.

General Wiring Guidelines

- Route wiring away from sources of noise such as alternators, ignition components, or other high power/frequency wiring
- Shielded wire is suggested to reduce the susceptibility of noise; the shield should only be grounded/drained on one end of the wiring harness
- CAN wiring should utilize twisted pairs (> 1 TPI); shielding is recommended

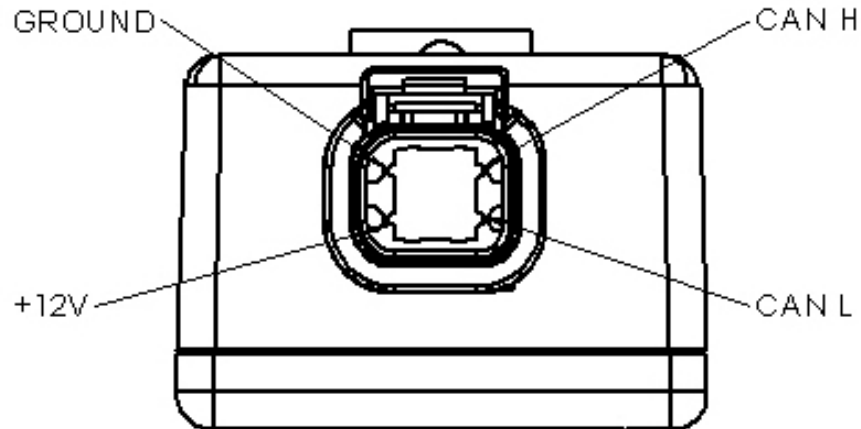

Pin	Name	Function
1	AEMnet+ / CANH	AEMnet / CAN bus output
2	AEMnet- / CANL	AEMnet / CAN bus output
3	12V Battery Power (+)	Primary ignition/battery power input
4	Ground (-)	Power Ground

Thermocouple Sensor Wiring

- K-type thermocouples have an industry standard marking in North America: Red is negative (-), yellow is positive (+). Despite this, some sensors and/or wiring come with alternative coloring. If in doubt, contact the manufacturer.
- Specific K-Type thermocouple wire (**not** copper) must be used for all wiring, extensions, and connections. Failure to do so will result in inaccurate readings.
- Connect K-Type sensors to each of the numbered (1 - 8) yellow 'miniature' thermocouple receptacles on the Module.
- The receptacles are polarized, positive (+) and negative (-). Reversing this connection will result in inaccurate readings.
- Route wiring away from sources of noise such as alternators, ignition components, or other high power/frequency wiring
- Shielded wire is suggested to reduce the susceptibility of noise; the shield should only be grounded/drained on one end of the wiring harness

Cold Junction Compensation

Due to the nature of thermocouples, a "cold" junction sensor has been implemented to provide the most accurate temperature measurements. This sensor is embedded within the device, all compensations are automatically applied, and no further action is required by the user. The output of the cold junction sensor is equivalent to the temperature within the Module and is provided via CAN for reference purposes. The thermocouple sensors' temperature measurements output via CAN are *already* CJ compensated and require no further manipulation by the user.

Jumper Configuration

Two configuration jumpers are located inside the enclosure of the Module. The cover may be removed by unscrewing the four external screws to change the jumper positions if needed. The Module is delivered from the factory in the most common configuration suitable for use with AEMnet (and other) devices; changing the jumper positions is not typically necessary.

CAN CFG - The default position of 500 kb/s & 29 bit ID is correct for AEMnet. Please refer to the manufacturer's documentation if you are using any third-party devices.

UNIT ID - The default position is correct if there is only a single AEM K-Type CAN Module installed on your network. If you are using two Modules, the first unit must be set to 'UNIT 1' and the second to 'UNIT 2'.

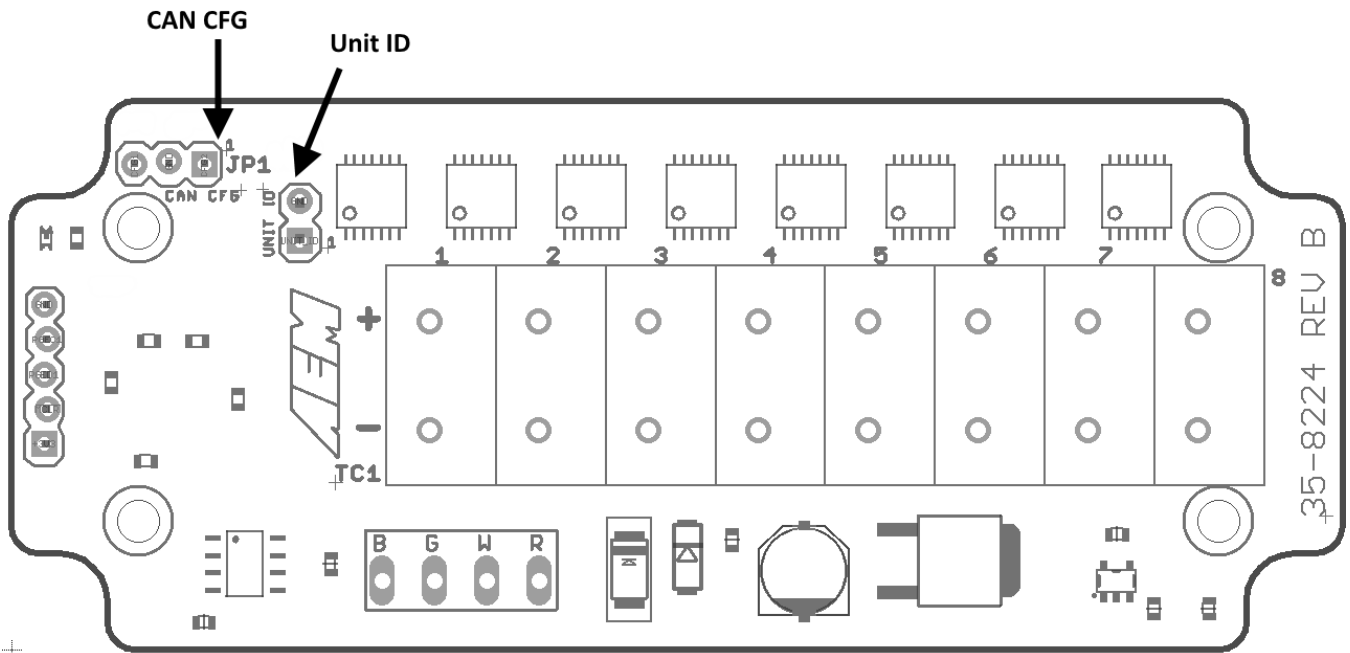

	No Jumper	1 - 2	2 - 3	Description
UNIT ID	UNIT 2	UNIT 1*		First or Second Unit on Bus
CAN CFG	250 kb/s 11-bit ID	500 kb/s* 29-bit ID	1000 kb/s 29-bit ID	Bus Speed / ID Type

Jumper Position (* = Default Position)

Compatible Sensor and Accessory Part Numbers

The following is a list of compatible sensors and accessories.

AEM PN	Description
30-2065	K-Type Closed Tip Thermocouple Sensor Kit. Inconel Sheath. 1/8" NPT Compression Fitting. Includes: K-Type Closed Thermocouple Sensor, 1/8" Compression Fitting & Ring Terminal Harness
30-2066	K-Type Closed Tip Thermocouple 10' Wiring Extension Kit. Includes: 10' Wiring Extension, 2 X 4-40 Hex Nut, 2 X 4-40 Screw & 6" Heat Shrink Tubing
30-2068 30-2068-2 30-2068-4	K-Type Closed Tip Thermocouple Kit. Inconel Sheath. 1/8" NPT Compression Fitting. Includes: AEM Part Numbers 30-2065 & 30-2066, (-2) and (-4) versions include either 2 or 4 sensor and extension combinations
30-3606	AEMNet Extension Cable 2 feet Kit
30-3607	AEMNet Extension Cable 5 feet Kit
30-3608	AEMNet Extension Cable 10 feet Kit
35-3440-F	AEMnet Female Termination Plug
35-3440-M	AEMnet Male Termination Plug
35-2624	DTM-Style 4-Way Plug Connector Kit. Includes Plug, Plug Wedge Lock & 5 Female Pins
35-2625	DTM-Style 4-Way Receptacle Connector Kit. Includes Receptacle, Receptacle Wedge Lock & 5 Male Pins
35-2626	DTM-Style 4-Way Connector Kit. Includes Plug, Receptacle, Plug Wedge Lock, Receptacle Wedge Lock, 5 Female Pins & 5 Male Pins

Specifications

Dimensions	width	1.8 / 45.8	in / mm
	length (excl. connector)	4.0 / 103	in / mm
	height	1.4 / 35	in / mm
	mass	3.8 / 110	oz / g
Supply Voltage	min	7	VDC
	max	18	VDC
Supply Current (13.8V)	nominal	70	mA
Operating Temperature	min	-4 / -20	degF / degC
	max (16V Supply)	185 / 85	degF / degC
K-Type Thermocouple Inputs	Input Protection	+/- 45	VDC
	Minimum	-328 / -200	degF / degC
	Maximum	2501 / 1372	degF / degC
	Resolution	0.1	degC
	Full-Scale Error	+/- 0.15 (Max)	%
	CAN Transmit Rate	10	Hz
Cold Junction Sensor	Minimum	-67 / -55	degF / degC
	Maximum	257 / 125	degF / degC
	Resolution	0.1	degC
	Accuracy	+/- 0.7 (Max)	degC
	CAN Transmit Rate	2	Hz
CAN	Bit Rate (User Configurable)	250 / 500 / 1000	kb/s

	ID Type (User Configurable)	11 / 29	bits
	Termination	None	Ohm
	DLC	8	Bytes

FAQ / Troubleshooting

My Module doesn't seem to be outputting anything.

Confirm that your CAN bus is properly terminated and that all nodes are configured for the right bus speed. In addition, any receiving devices/nodes must be specifically configured to receive as the Module is configured to transmit; specifically, the CAN ID, bus speed, and number of ID bits.

The temperatures that my module is outputting don't make sense.

Thermocouple wires have polarity meaning there is a positive (+) and negative (-) wire. Please ensure that the polarity is correct from the sensor, through any extensions, and to the correct terminal on the Module. The polarity is marked on the top of the enclosure of the Module. All sensor wiring and/or extensions must be constructed of the proper K-type alloy wire. The Module will output a temperature of "3276.7 degC" when a channel does not have a sensor plugged in.

Can I use the Module with my AEM CAN Gauge

No, the CAN Sensor Module is only compatible with CD-series dash displays, AEM AQ-1, AEM Infinity ECUs and other third-party devices at this time.

Where can I find AEM .dbc files?

AEM dbc files are available via the AEM Forum and within the AEM CD-series dash display software installer. Please visit www.aemelectronics.com for more information and downloads.

For support, contact AEM Technical Support at 1-800-423-0046 or gentech@aemelectronics.com.

AEMnet (CAN Bus) Output

WHITE WIRE = AEMnet+ / CANH

GREEN WIRE = AEMnet- / CANL

Bus Termination

All AEMnet/CAN networks must be terminated to have an equivalent of approximately 60 Ohms of resistance. Generally, this means a 120 Ohm resistor connected in parallel to AEMnet+/AEMnet- (or CANH/CANL) at both physical ends of the bus run.

CAN DBC definition files are available at

www.aemelectronics.com

bit rate	Selectable via Jumper	kb/sec
format	Selectable via Jumper	bit ID
terminating resistor	NONE	
endianness	big / Motorola	
DLC	8	

Unit 1: 0x0000BA00 (29) / 0x5A0 (11) at 10Hz

Unit 2: 0x0000BB00 (29) / 0x5B0 (11) at 10Hz

Byte	Label	Data Type	Scaling	Offset	Range
0	Thermocouple1	16 bit signed	0.1 degC/bit	0	-3276.8 to +3276.7 degC
1					
2	Thermocouple2	16 bit signed	0.1 degC/bit	0	-3276.8 to +3276.7 degC
3					
4	Thermocouple3	16 bit signed	0.1 degC/bit	0	-3276.8 to +3276.7 degC
5					
6	Thermocouple4	16 bit signed	0.1 degC/bit	0	-3276.8 to +3276.7 degC
7					

Unit 1: 0x0000BA01 (29) / 0x5A1 (11) at 10Hz

Unit 2: 0x0000BB01 (29) / 0x5B1 (11) at 10Hz

Byte	Label	Data Type	Scaling	Offset	Range
0	Thermocouple5	16 bit signed	0.1 degC/bit	0	-3276.8 to +3276.7 degC
1					
2	Thermocouple6	16 bit signed	0.1 degC/bit	0	-3276.8 to +3276.7 degC
3					
4	Thermocouple7	16 bit signed	0.1 degC/bit	0	-3276.8 to +3276.7 degC
5					
6	Thermocouple8	16 bit signed	0.1 degC/bit	0	-3276.8 to +3276.7 degC

7					
Unit 1: 0x0000BA02 (29) / 0x5A2 (11) at 2Hz		Unit 2: 0x0000BB02 (29) / 0x5B2 (11) at 2Hz			

Byte	Label	Data Type	Scaling	Offset	Range
0	Cold Junction Temperature	16 bit signed	0.1 degC/bit	0	-3276.8 to +3276.7 degC
1					
2	Battery Voltage	8 bit unsigned	0.1 V/bit	0	0 - 25.5 V
3	n/a	n/a	n/a	n/a	n/a
4	n/a	n/a	n/a	n/a	n/a
5	n/a	n/a	n/a	n/a	n/a
6	n/a	n/a	n/a	n/a	n/a
7	n/a	n/a	n/a	n/a	n/a

AEMNet Hub

Introduction

The AEMNet CAN Hub is used to conveniently connect multiple AEMNet devices.

Features

- Integrated 4-way Deutsch DTM housings
- Compact size
- Rugged, potted assembly
- #4-40 mounting hardware included.

Kit Contents

- 1x AEMNet Hub Module
- 2 x Flat Head Screw, 4-40 x 7/8"
- 2 x Flat Washer, 4-40 x 0.375"
- 2 x Nylock Nut, 4-40 x 9/64"
- Instruction Sheet

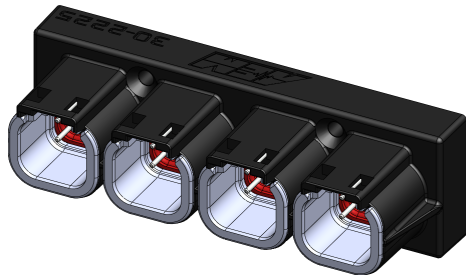

Device Pinout

Device Pinout

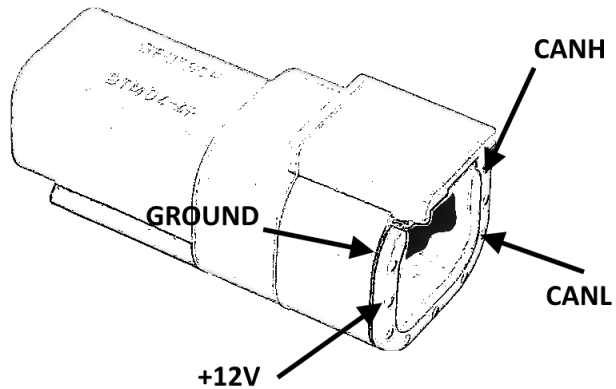

Pin	Function
1	AEMNet + (CAN Hi)
2	AEMNet - (CAN Lo)
3	Switched Power
4	Ground

All AEMNet hub ports have the same pinout. If powering devices through the hub, power and ground is only necessary on one port. The hub will distribute power to all other ports. The hub has a max current capacity of 3 amps. **Do not distribute UEGO sensor heater power through this hub.**

The AEM CAN Hub can be used with Non-AEMnet CAN Bus devices as long as all devices are compatible – communicating at the same Bus Speed.

Installation

Installation

The module may be mounted within the vehicle using hook-and-loop fastener (not included) or bolted (#4 screws included) to a suitable structure. The module is weather-resistant (IP67) and may be mounted in the engine compartment.

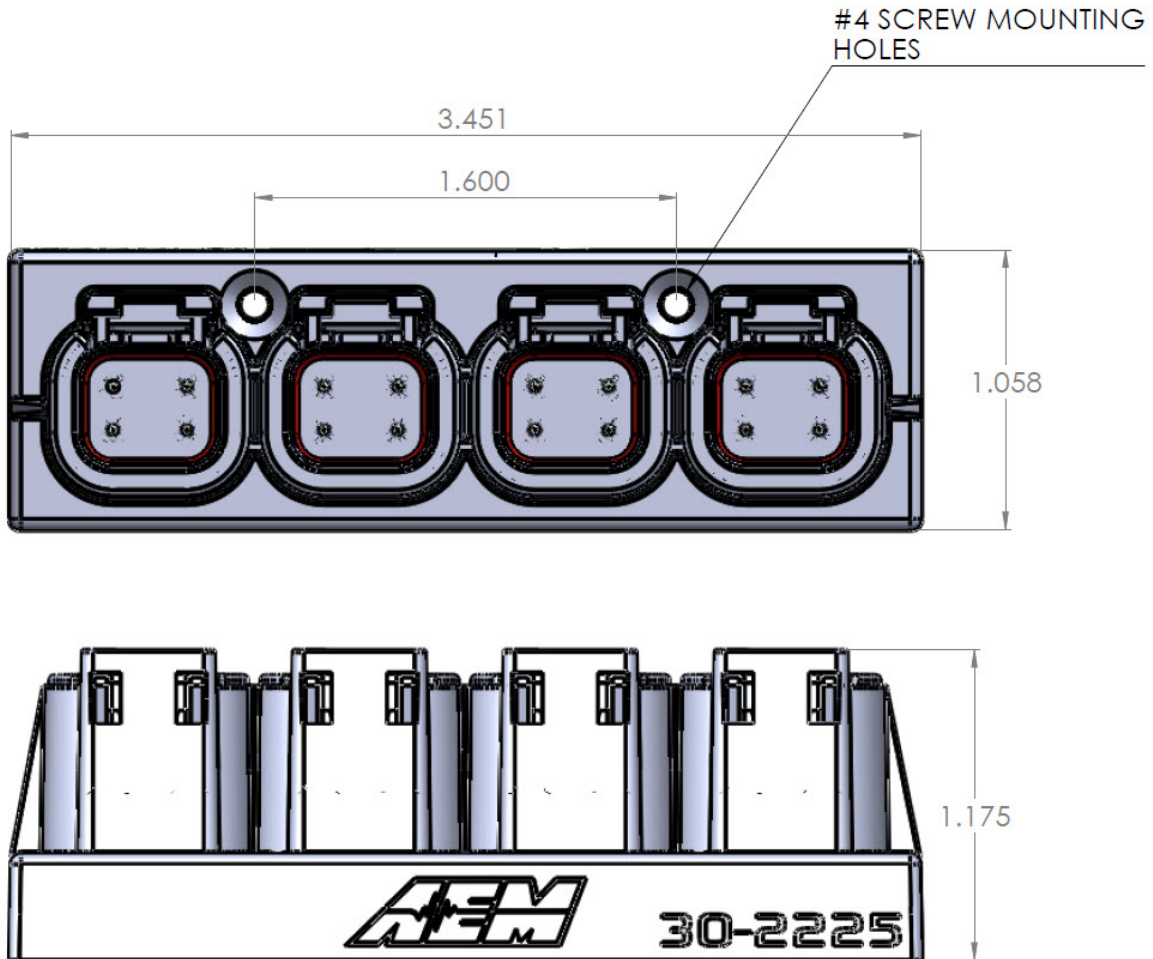

AEMNet Network Wiring

AEMNet Network Wiring

Refer to the following guidelines when wiring AEMnet (CAN) devices.

- Twisted wire is required with >1 twist per inch.
- AEMnet buses must be properly terminated. Termination resistors are 120 Ohms each, two total, located at the physical ends of the bus wires.

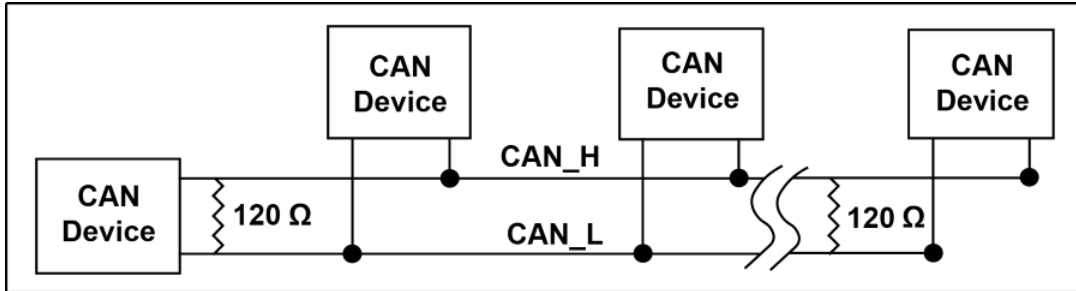

Termination Resistors

Device	Configuration
30-2226, 6ch CAN Sensor Module	No resistor
30-2224, CAN EGT	No resistor
30-2212, 22ch CAN Sensor Module	Jumper selectable
30-560X & 30-570X CAN Dash	Software selectable, enabled by default
30-710X, Infinity	Hardware enabled by default on CAN A (AEMNet)
30-2500, AQ1	Included, non-configurable

The following Deutsch DTM 4-pin termination plugs are available

PN	Description
35-3440-F	AEMNet Termination Plug, Female
35-3440-M	AEMNet Termination Plug, Male

Example Network Configurations

Example Network Configurations

Note: *These diagrams assume that there are no other devices on the network*

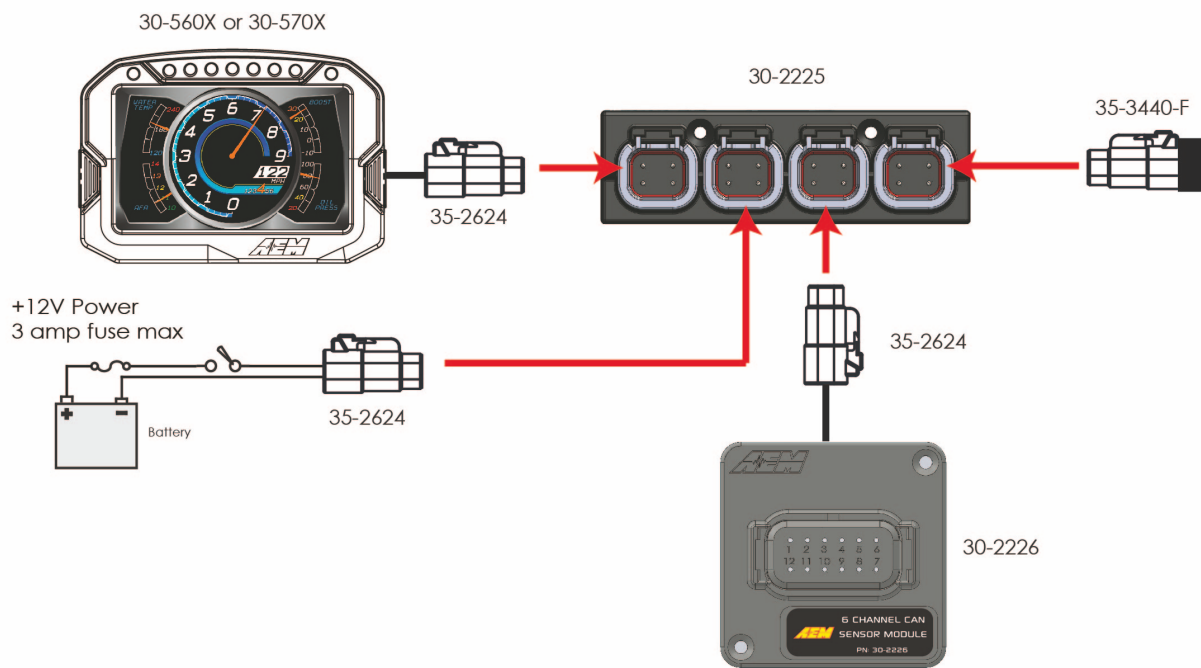
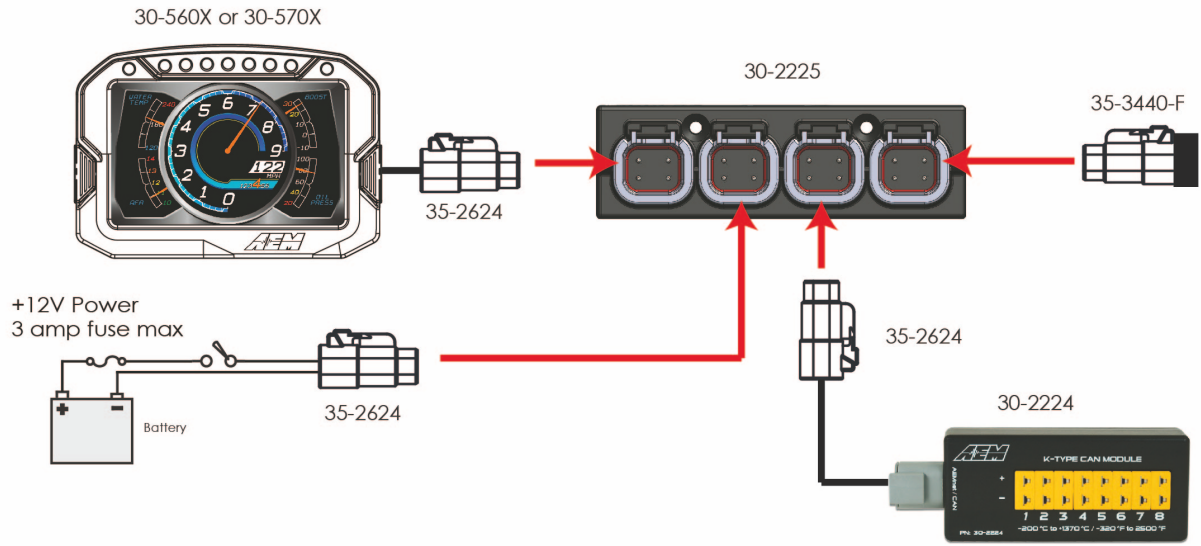

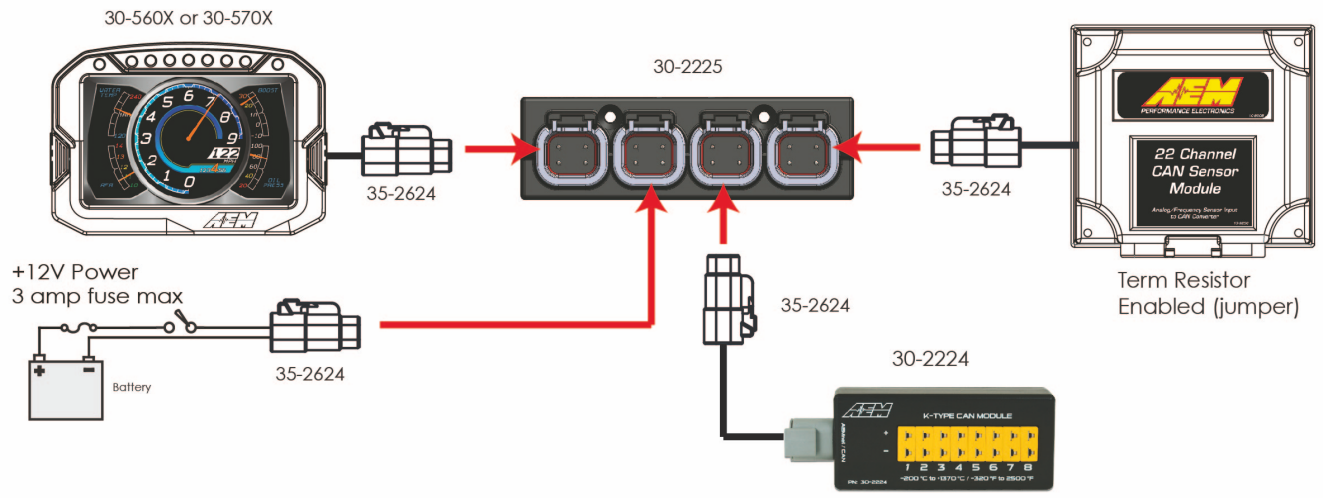
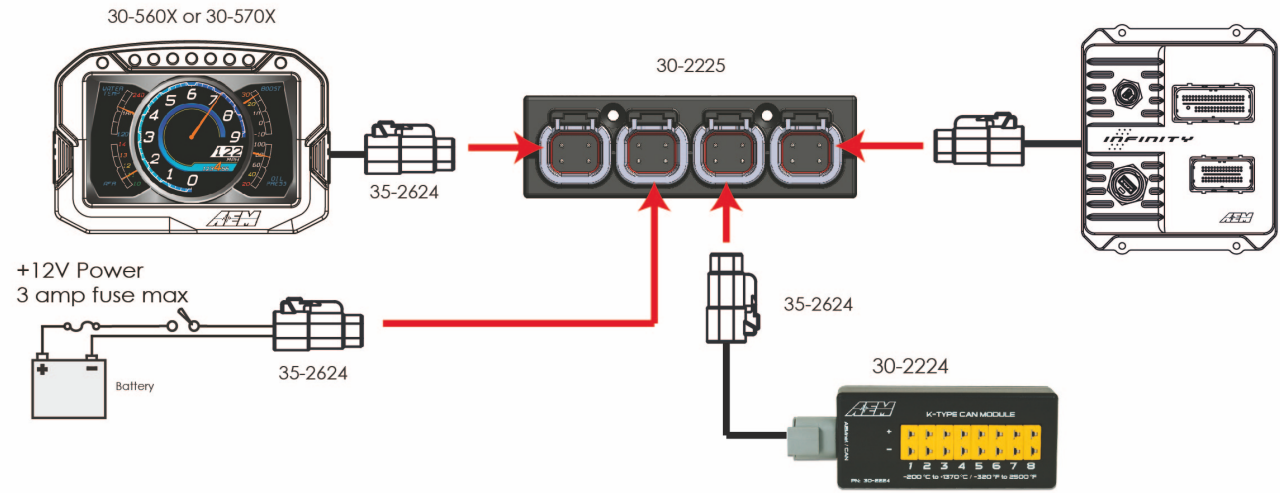

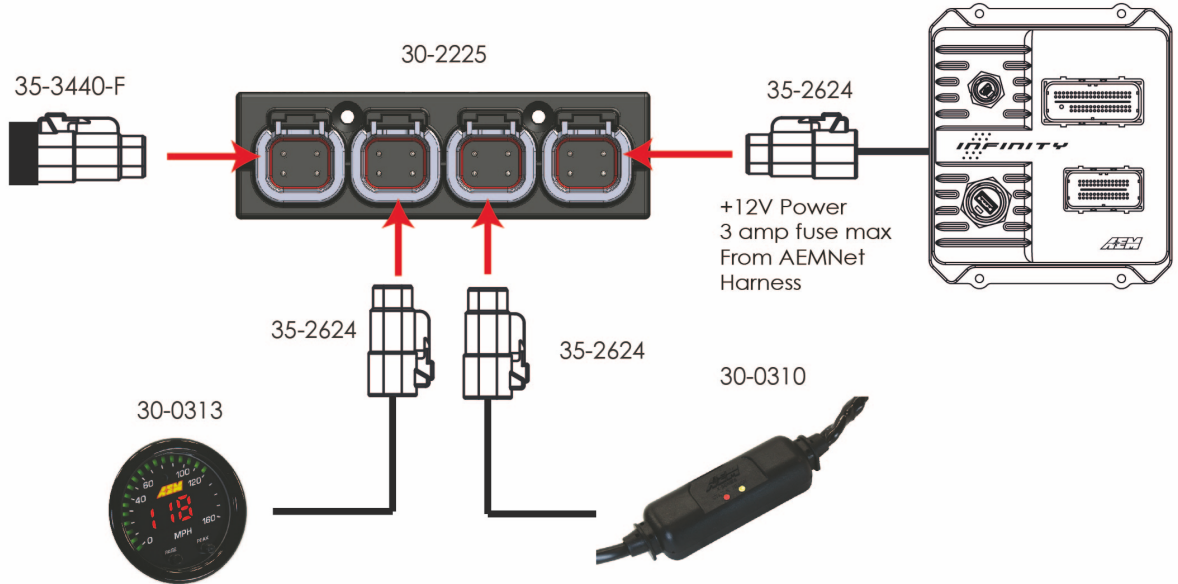
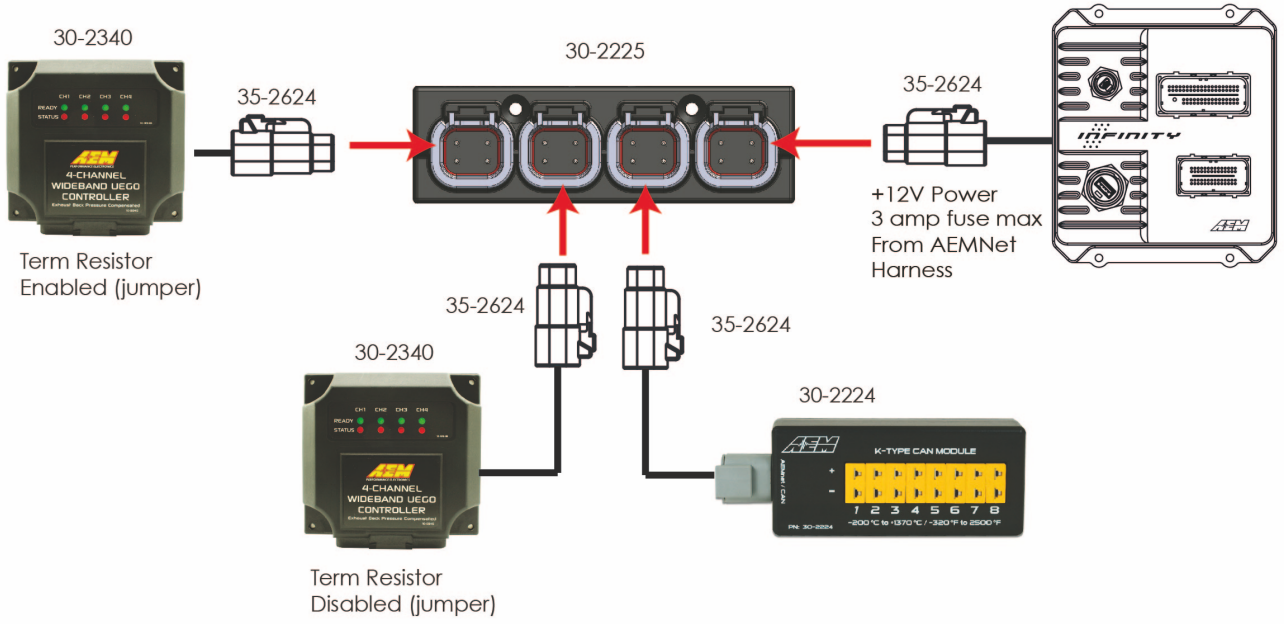

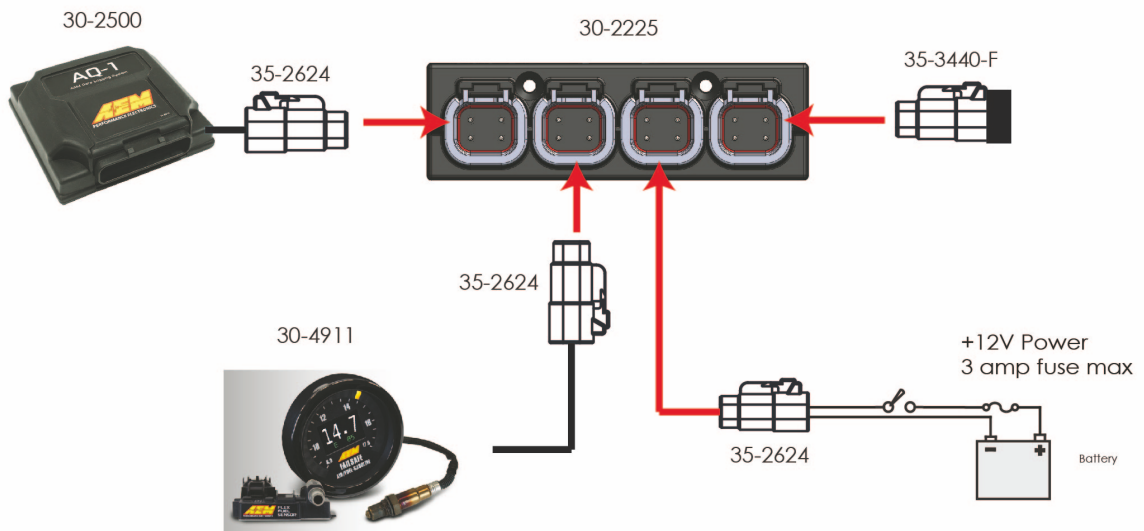
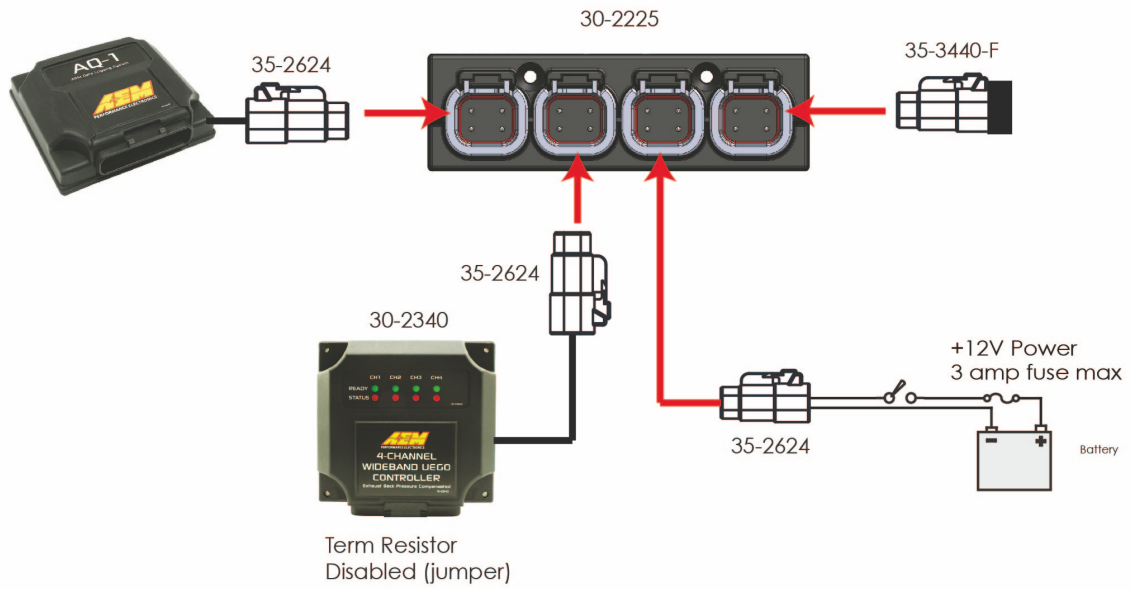

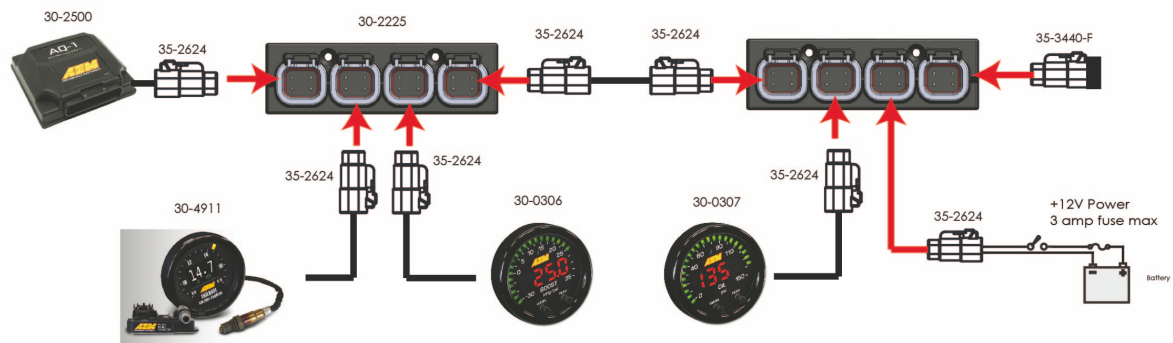

OBDII Setups

AEM's dash with optional OBDII interface cable P/N 30-2217 puts multiple channels of data at your fingertips by reading the CAN bus stream of your 2008+ model year vehicle's OBD port and transmitting those channels to the dash. To configure your dash for OBDII data display, the dash must first scan your vehicle's OBDII port to identify all ECUs and available PIDs. PID stands for Parameter ID. These are codes used to request specific data from a vehicle. To begin the scan process, Launch AEM Dash Design and go to **Tools | Scan Vehicle OBDII...**

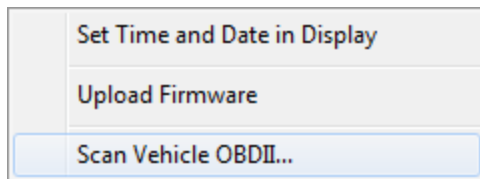

The OBDII Scan Wizard will launch to guide you through the process.

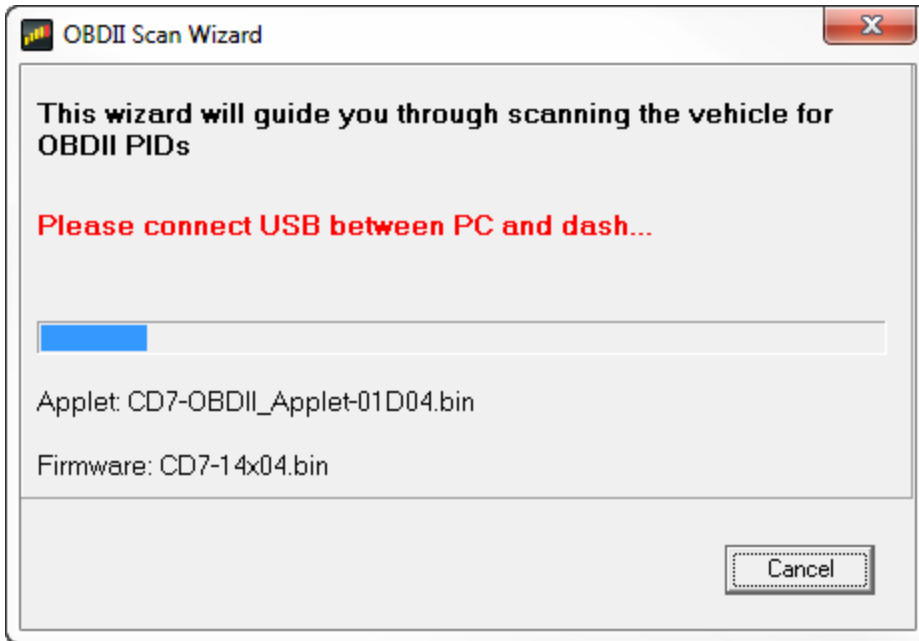

Be sure the dash is powered up and connect the USB cable between the dash and your PC and not plugged into the car yet.

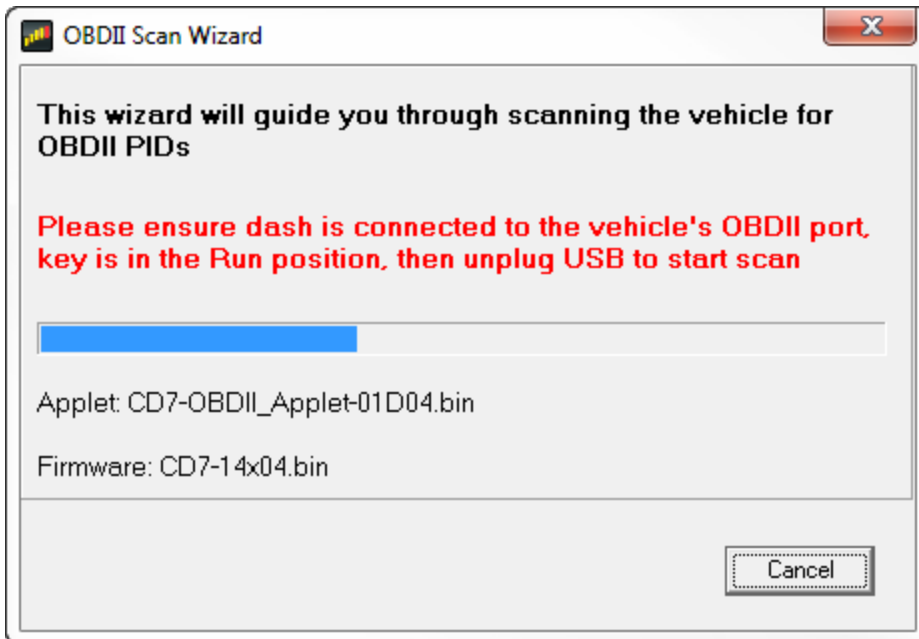

Connect the OBDDII connector to your vehicle's OBDDII port then unplug the USB cable to begin the scan.

OBDII Discovery Applet 01D03

CAN 1 ---	CAN 2 - 500kHz
No OBDII ECUs found	3 OBDII ECUs found
ECU 1: Not found	ECU 1: Found 21 PIDs
ECU 2: Not found	ECU 2: Found 5 PIDs
ECU 3: Not found	ECU 3: Found 3 PIDs
ECU 4: Not found	ECU 4: Not found
ECU 5: Not found	ECU 5: Not found
ECU 6: Not found	ECU 6: Not found
ECU 7: Not found	ECU 7: Not found
ECU 8: Not found	ECU 8: Not found

Discovery Complete, OBDII info logged

Reconnect USB cable to complete process

Port:1, Ecu:2, pids 01 to 1c

Port:1, Ecu:8, pids 01 to 46

The dash will scan your vehicle and identify all available PIDs. When the scan is complete the message *Reconnect USB cable to complete process* will be displayed **on the dash**. The following window will be displayed in the Dash Design software. At this point in the process, you have the option to press the right button on the dash to scroll through a live display of available PID data.

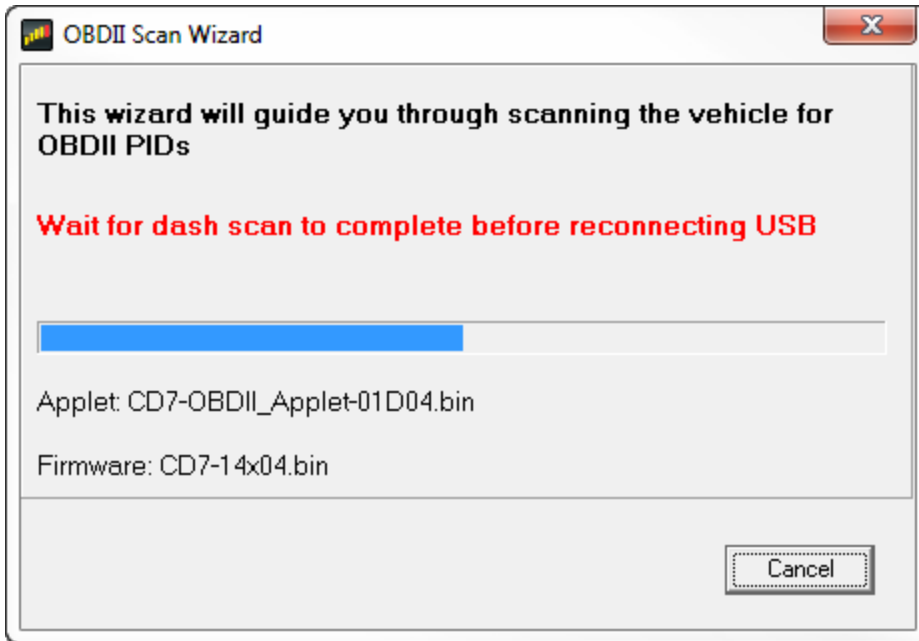

Connect the USB cable to your PC.

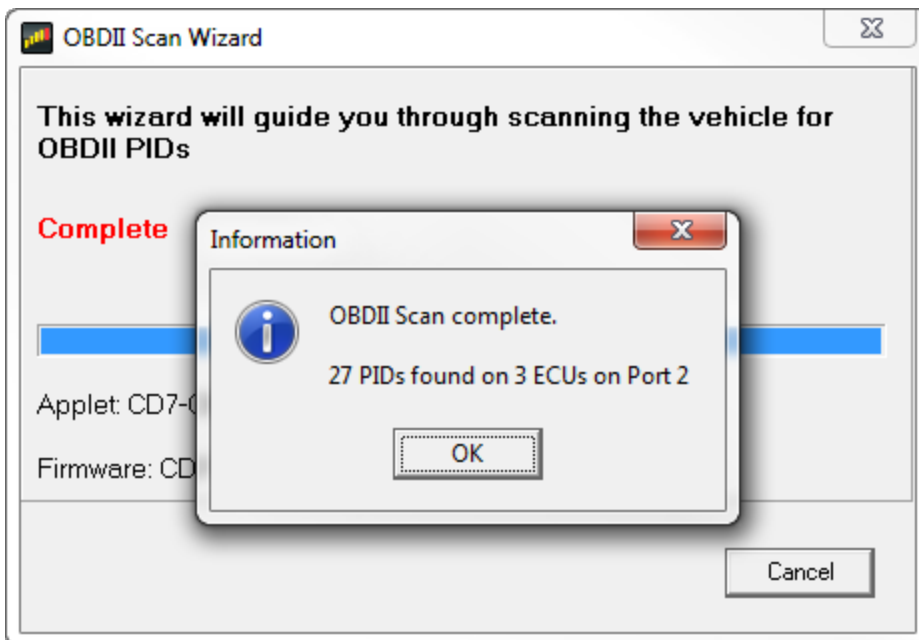

The scan is complete. Click OK to proceed. **NOTE: At this point, we recommend saving the setup file as there may have been changes applied during the scan process. You must upload your setup before proceeding by selecting File | Upload to Display... You can also use the hotkey combination Ctrl+U. If the setup file is not loaded into dash after completing OBDII Scan Wizard there can be errors or missing data.**

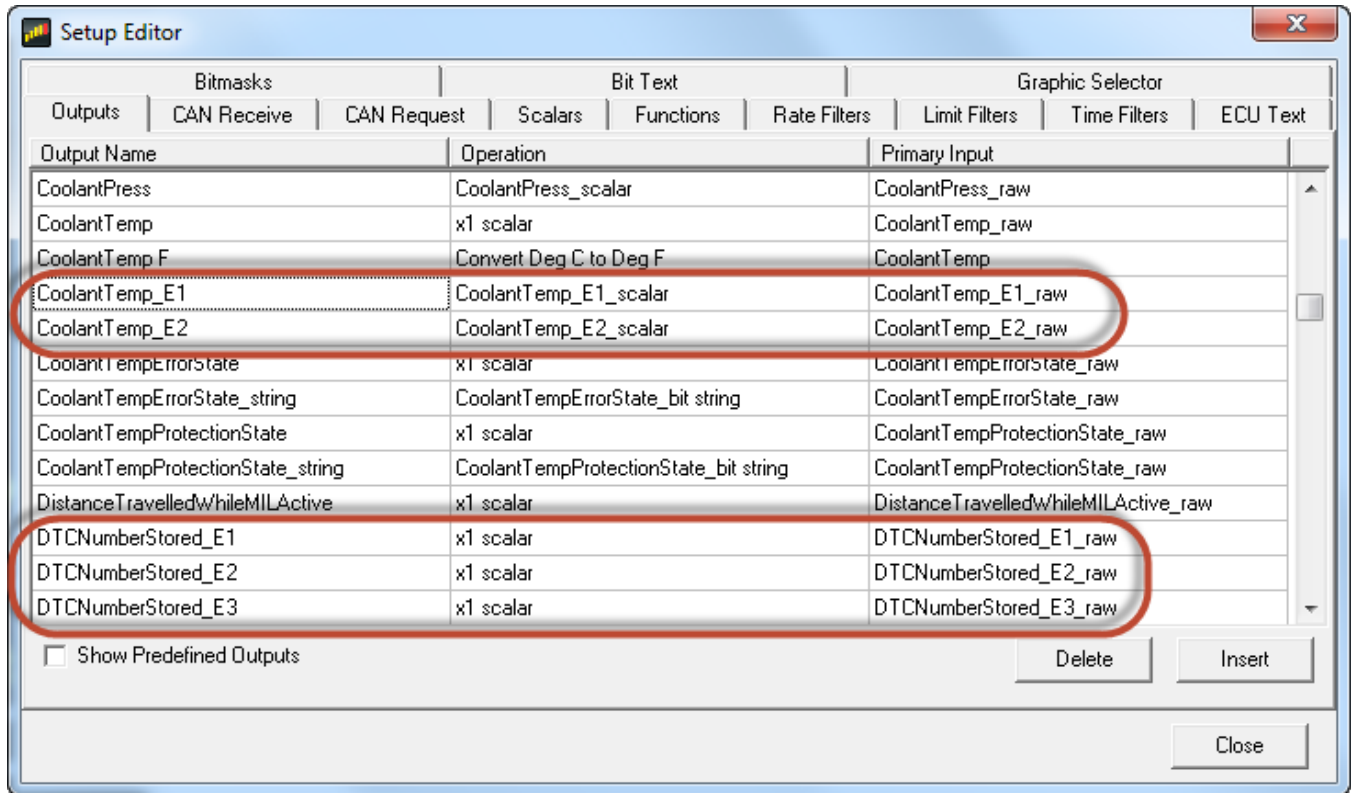

Open the Setup Editor. OBDII PIDs will be automatically added to your list of available outputs. The circled examples above represent the same PID from different vehicle ECUs. In these cases, the system will append a suffix E2 for ECU2 and so on but can be ignored as they are non standard PIDs and may perform differently from expected. These outputs are now available for use as inputs to gauges for display on your dash. To see a complete list of PIDs obtained from your vehicle, click on the CAN Receive tab and choose to show Port 2. Port 2 is the default for OBDII messages.

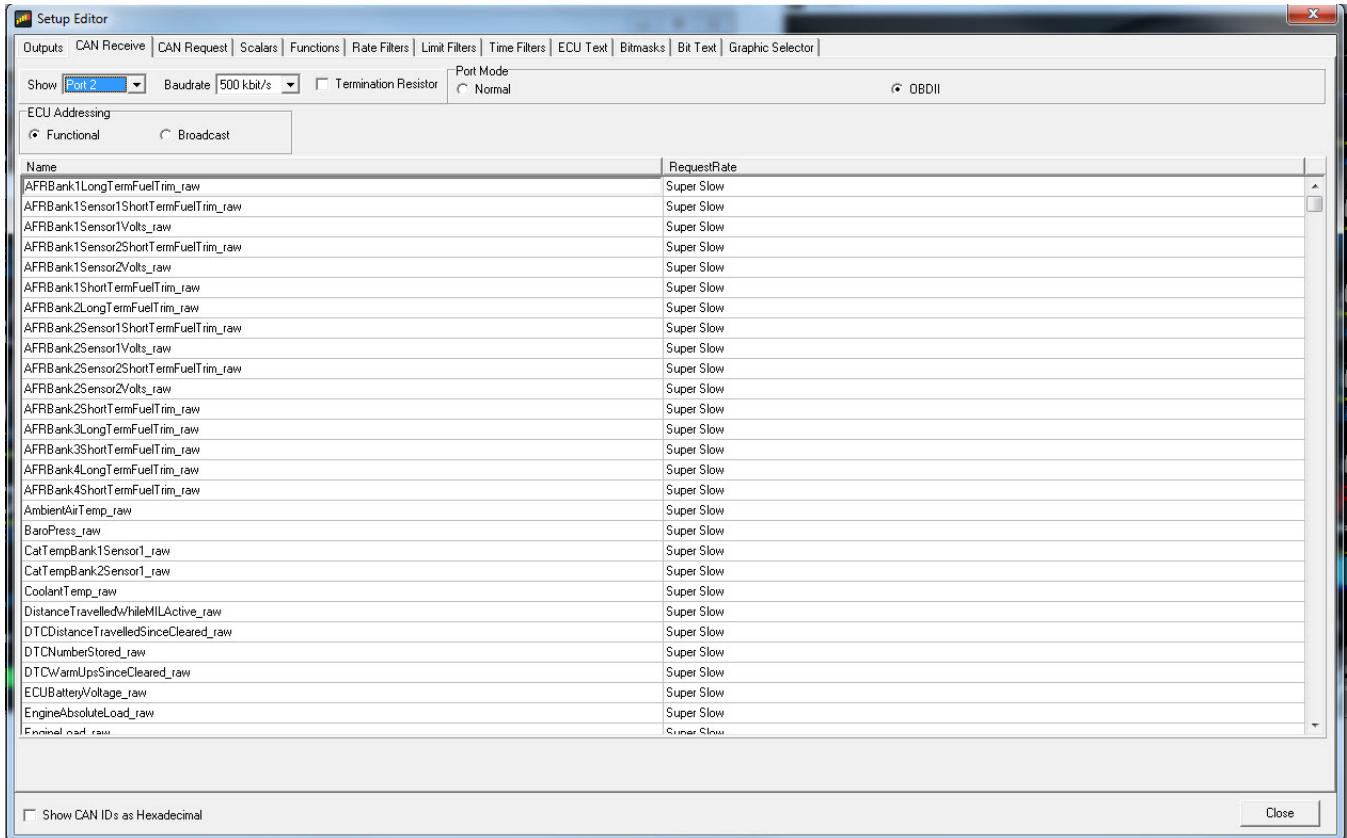

This is a complete listing of available PIDs. AEM supplied setup files for OBDII messages will be located in the \Documents\AEM\DashDesign\Setups\App Specific\OBDII folder.

The complete PID list will vary between cars so modification to the default setup is encouraged to view desirable data.

Two ECU Addressing options are possible. This allows the user to select between functional and broadcast message addressing. Functional addressing is the default configuration. Some vehicle platforms require Broadcast addressing. Currently, the only known platform requiring this setting is the 2006-2013 2nd generation Mini Cooper. Without this setting enabled, the OBDII PID discovery process will complete normally but no data will be displayed on the dash. To apply this setting, complete the OBDII Scan Wizard normally following all screen prompts. At the end of the process, go to Setup | Display... and select the CAN Receive tab. Select the Broadcast radio button as shown in the screen shot above. Save the setup file and finally upload it to your dash.

Note: Any PID not logged or displayed on the setup will not be used or active while car is running. To better view important data, increase request rate and remove unnecessary PIDs from setup.

Editing Display Setups

The display setup file has the extension .aemcd7 and contains all the information needed to configure a color display including connection definition, sensor calibration and screen layout.

Opening and Saving Setups

To Open an existing color display setup:

- Select **File | Open...**. The file open dialog is shown.
- Select the required display setup file and click **Open**.

The last five files opened can be accessed by selecting **File | Reopen** followed by the appropriate file from the sub menu.

To save a setup under a new filename, select **File | Save As....**, enter a file name in the file save dialog and click the **Save** button. To save a setup with the current name, select **File | Save**.

If a setup or AEM DashDesign is closed and the setup has changed since the last save, a prompt will appear asking if the changes to the setup are to be saved. Select **Yes** to save the changes, **No** to abandon the changes or **Cancel** to return to editing the current setup.

Creating a New Display Setup

To create a new display setup:

- Select **File | New**
- Select **Setup | Display | CAN Receive**

Default Display Setups

AEM supplied setup files will be located in the \Documents\AEM\DashDesign\Setups folder.

You can copy entire pages from another file. First, make sure the target page is open and selected and that the layout is unlocked.

Select: **Edit | Paste Screen From Setup File**

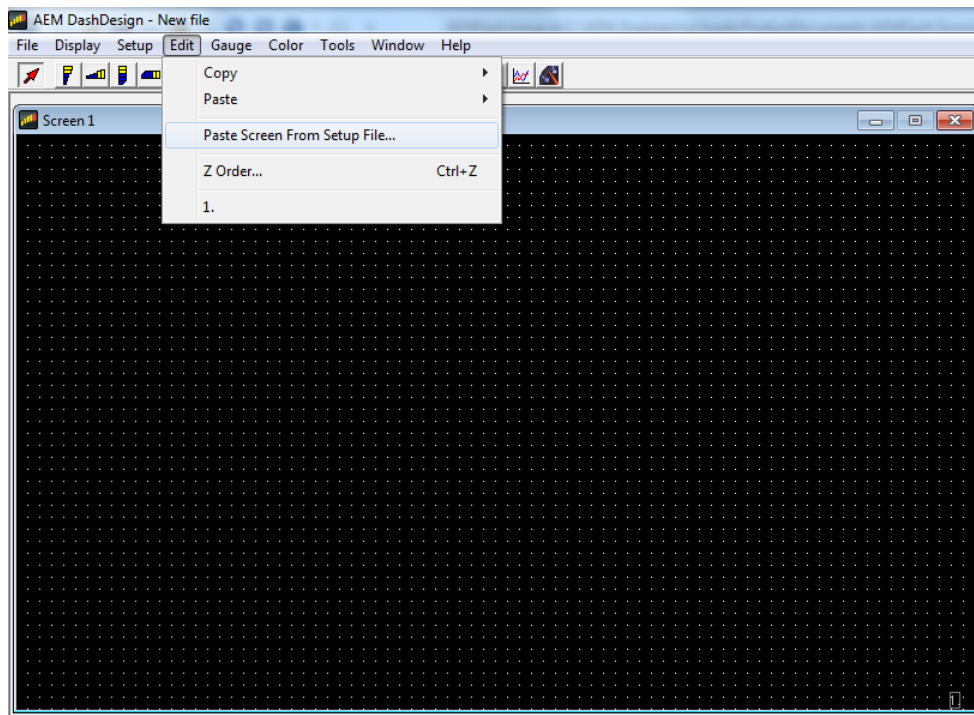

Select the file that contains the screen you want to copy. A window will open showing the six screens in the target file.



Select the screen you want to import by clicking on the screen name and Clicking OK.

Basic Editing of Default Setups

To view screens for editing go to **Display | Screen X**

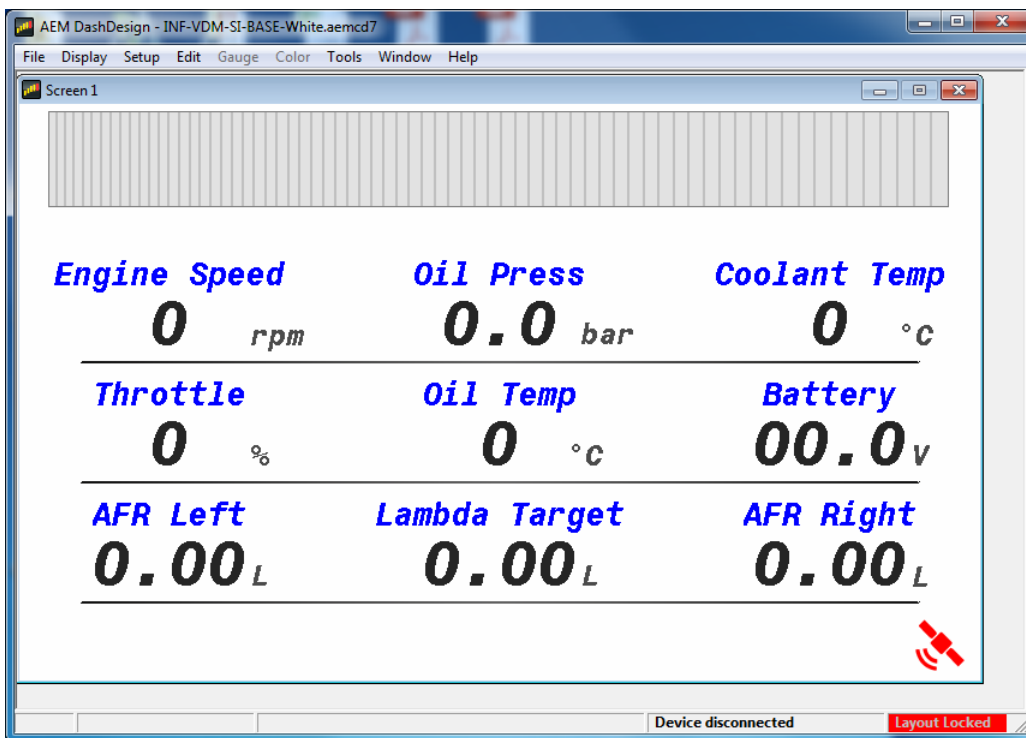
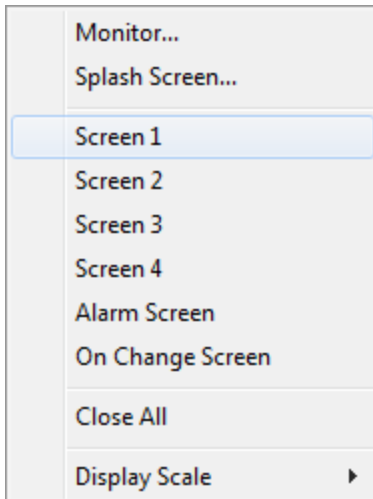

Layout Locked

The Layout Locked feature displayed at the bottom right of the screen prevents unwanted moving of screen items.

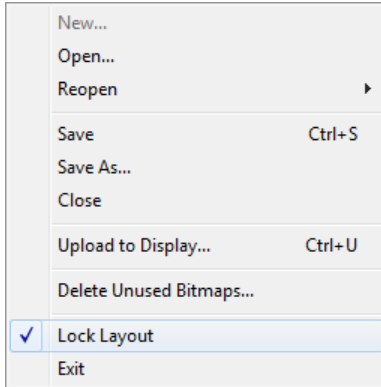

The Layout Locked feature can be disabled by going to **File | Lock Layout** or by clicking the red Layout Locked area of the screen. Caution as inadvertent clicks and drags can move items unintentionally. Some basic editing of the default screens is possible even with the Layout Locked feature turned on. It is a good idea to leave the Layout Locked activated until you specifically need to move or delete a gauge. Having it on prevents you from accidentally moving a gauge or deleting one inadvertently. When the layout is locked, the editing icon menu is hidden.

Engine Speed

0 rpm

Double clicking on the Engine Speed text label in the example above will display the available editing menu.

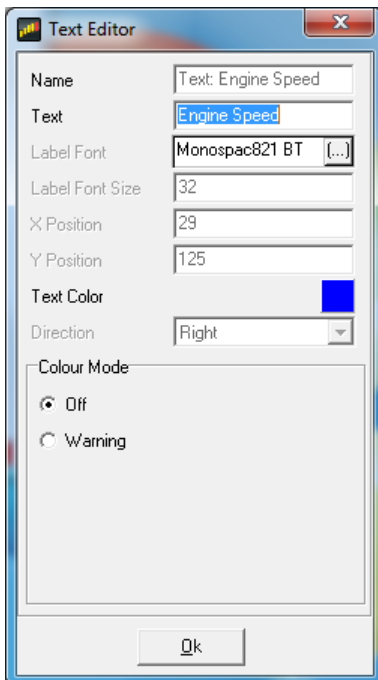

The dialog allows editing of all unlocked characteristics if Layout Locked is turned on. Locked characteristics are typically related to size and position. To change the text displayed in the text label example above, simply highlight the text and edit. Double clicking on the "0" in the example above opens the value label editor. This is live data displayed on the screen.

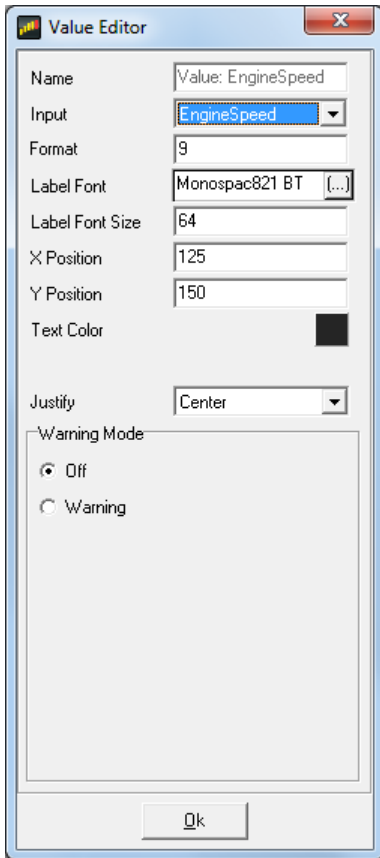

Here you can change the input displayed at this location. Click on the drop down to view a list of available channels.

Uploading a Setup to a Display

Uploading a setup programs the current setup into the color display.

AEM DashDesign communicates with the AEM Dash via USB.

To upload a setup:

- [Open](#) a display setup.
- Connect the AEM Dash to the PC using a USB cable. The AEM Dash will go into upload mode and will show "**USB cable connected**".
- Select **File | Upload to display...** or press Ctrl + U
- A dialog box will appear indicating the setup is being sent
- On the AEM Dash, the upload progress will be shown as a percentage. This progress percentage IS NOT shown in the AEM DashDesign interface.
- Once the setup has been received the flash will be erased; the AEM Dash will show "**Erasing flash**". This process will take a few seconds.
- Once the flash has been erased, it will be programmed; the AEM Dash will show the progress of programming as a percentage. Do not remove the power to the display at this point.
- Once the programming has finished, an **Upload complete, OK to disconnect** message will be displayed as shown in the example below. Unplug the USB cable to reboot the dash with the new setup. Do not disconnect the USB cable before this message is displayed.

Downloading a Setup From a Display

Firmware 14x20 and later allows for layout files to be downloaded from the CD dash display. It is important to note that only layouts that have been uploaded to the dash with Allow Downloading enabled will be able to be downloaded. It is also important to note that any layout file uploaded to a dash that has Allow Downloading enabled can be downloaded by anyone with PC access. If file security is a concern, it's advised to not enable Allow Downloading in order to limit access to ones files.

To allow a file to be downloaded from a CD dash, first enable Allow Download (go File>Allow Download) and then upload the layout to the dash. Now this file maybe downloaded by anyone with PC access to the dash. If file security is a concern, it's suggested to not enable Allow Download.

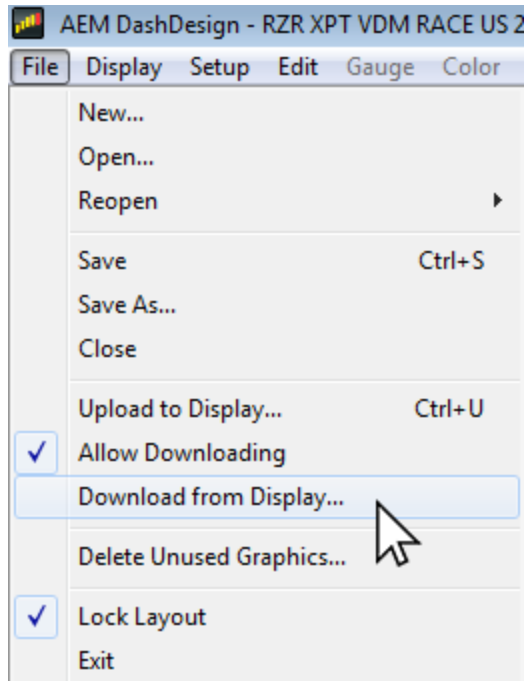

To download a layout from a display, go File>Download from Display and save the file when prompted.

The Display Editor

The display editor is the core tool for editing a setup. To open the tool, go to **Setup | Display...**

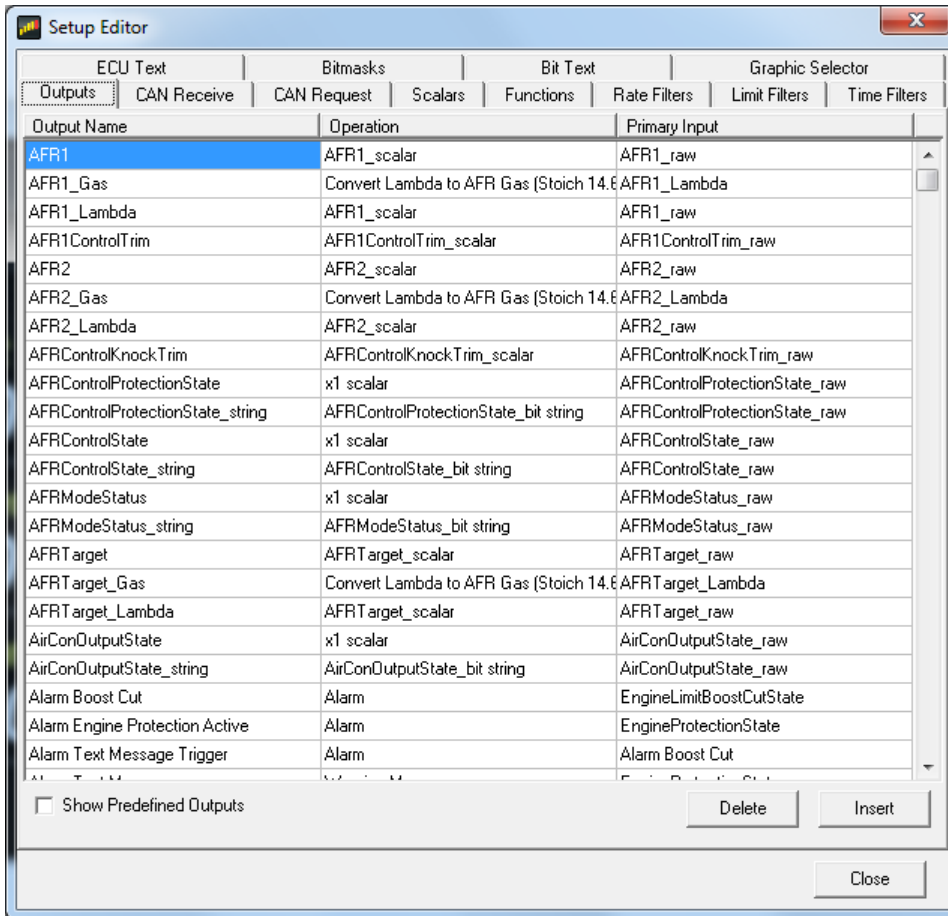

You can think of the display editor as a collection of tools for creating items on your screens. An AEM DashDesign setup consists of four logical components: Sources, outputs, sensors and gauges. These are defined as follows:

- **Sources** or primary inputs are raw data manipulated by an operation.
- **Outputs** are objects that obtain information from one or more sources or other outputs. An output manipulates the obtained data according to the operation associated with the output. The result can then be used in a gauge or another output.
- **Operations** are objects that define how the data is manipulated by an output. Examples of operations are scalars, functions and alarms.
- **Gauges** are objects that are placed on a screen page. There are two types of gauge; static and variable.
 - **Static** gauges do not change their appearance on the screen and include gauges such as text labels or graphics.
 - **Variable** gauges change their appearance to reflect data obtained from an output. Examples of variable gauges are bar graphs, tachos and numerical text gauges.
- **Predefined Outputs** are pre-configured within the system and can be used in many ways. Some examples include: Log Mem Free (kb) which displays the amount of free logging memory (logging versions only) and Night Mode Input Status. This output displays the state of the Night Mode 12v input (Grey wire in flying lead bundle).

Show Predefined Outputs

Click the Show Predefined Outputs box in the Display Editor to add all Predefined Outputs to the list.

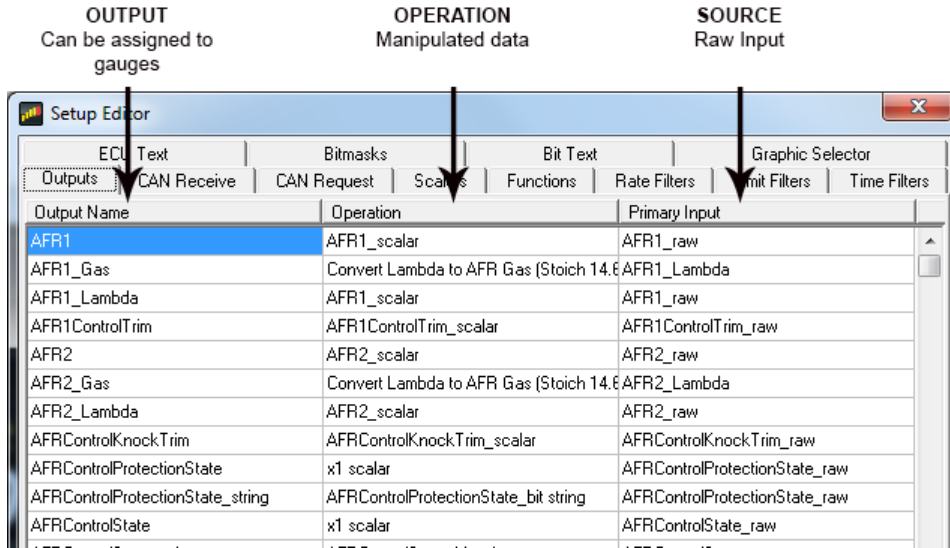

Default CAN .dbc Support

The AEM DashDesign includes a CAN .dbc import feature. A .dbc file is a standardized format for defining a set of CAN messages. Click on the CAN Receive tab in the Setup Editor.

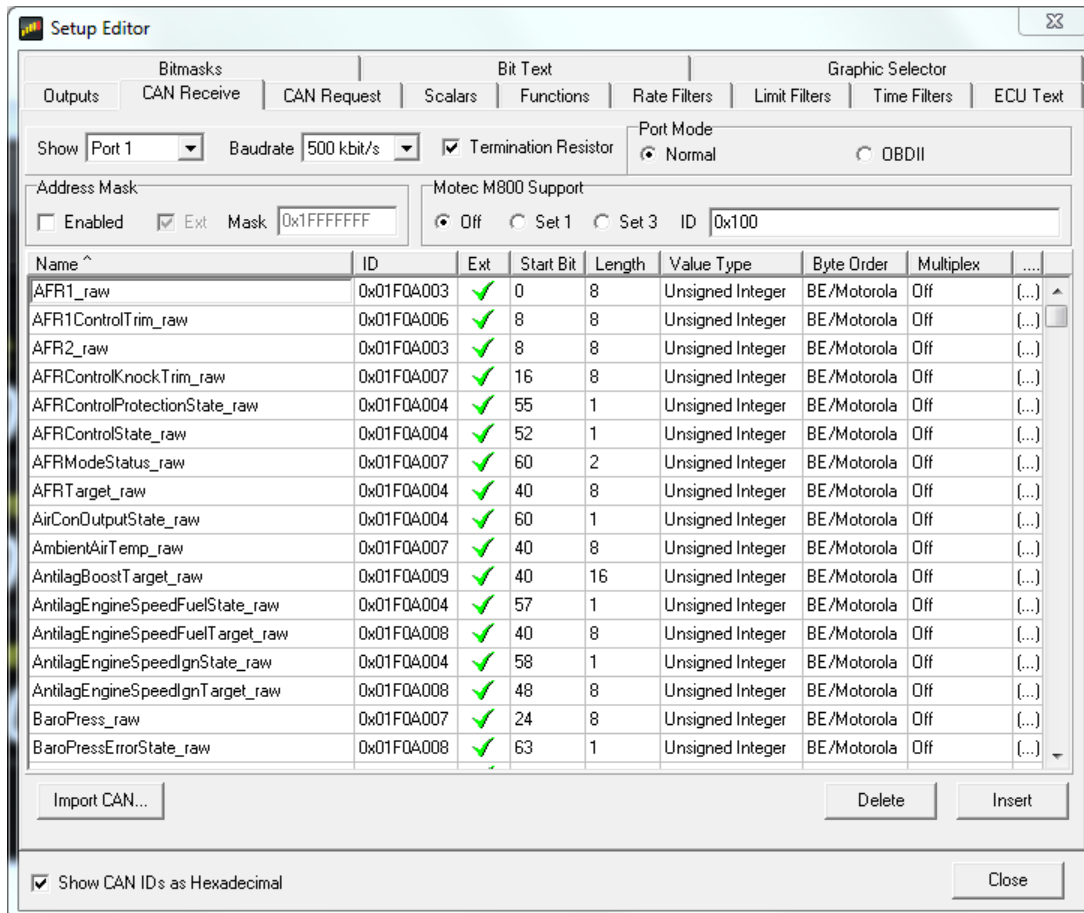

Click on the Import DBC... button to load or append a new .dbc file.

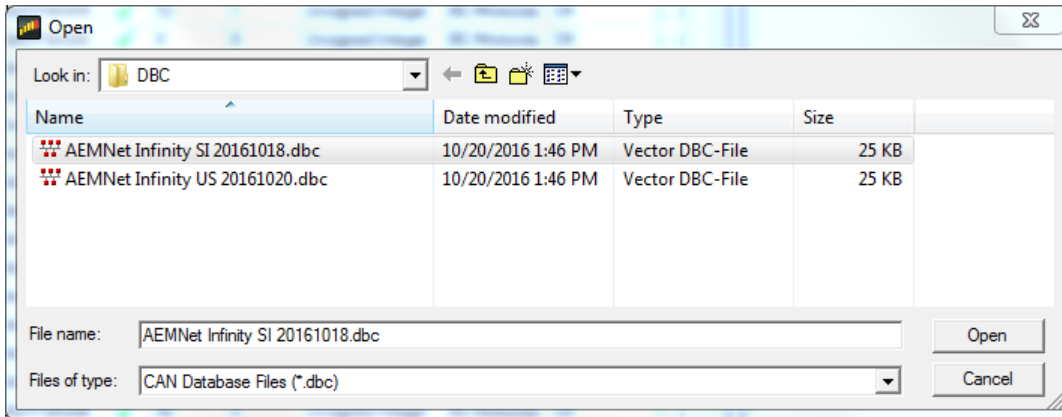

Available .dbc files will be located in the \Documents\AEM\DashDesign\DBC folder. Selecting a file will open the import dialog.

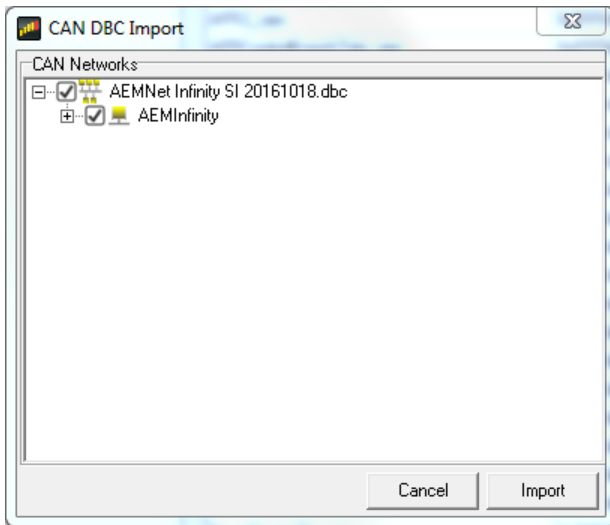

The levels can be expanded by clicking on the plus symbol.

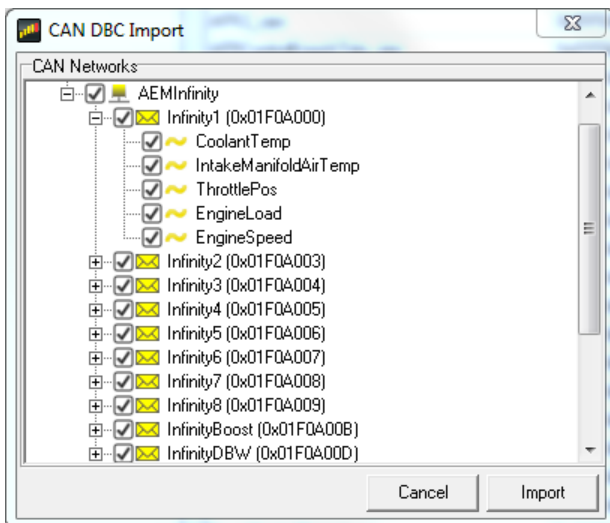

Select the channels for import by clicking the boxes. All available channels are selected by default. Click the Import button to import. All CAN message information is automatically imported along with necessary Scalar and Bit text operations. The channels are now available for assignment.

Logging

AEM Dash has 200Mbytes of internal data logging memory and supports logging rates of up to 1000Hz. Data is downloaded and analyzed with AEMData Analysis software.

To configure logging, select **Setup | Logging** to show the log setup window. Channels available to be logged are shown on the left hand side. To log a channel, select the desired rate from the Log Rate column. Logging a specific channel also automatically selects all other children and parent channels for logging at the same rate.

AEM Dash inserts markers in the data to indicate various states and these are displayed in AEMData. The following markers may be inserted by AEM Dash:

- **Lap** - This is inserted when the beacon input is triggered and is typically used for lap timing.
- **Power** - This is inserted when the display is configured to start logging immediately on power up.
- **Log Start** - This is inserted when the log start condition is met after power up
- **Overrun** - The display has been unable to write the log data to the memory in the time available. Either reduce the number of logged channels or reduce the complexity of the display screen.

Log start/stop conditions

The logging can be started or stopped dependent on channel conditions. Every time a new log is started, a new *Log Run* is created in the logger. Log runs can be downloaded individually with AEMData which reduces the time taken to download the data.

The log can be started in one of three ways:

- **Single input start/stop** - When the specified input is non zero, the log will be started. When zero, the log will be stopped. For example, if the channel EngineSpeed is used as the trigger, the logger will log anytime the engine is running.
- **Twin start/stop triggers** - When the Start trigger is non zero, the log will be started. When the Stop trigger is non zero, the log will be stopped.
- **Log Always** - The logging starts logging immediately on power on and will log until switched off or until the log is full.
- **Enable Loop Logging** - Click to select the loop logging feature. The logging will loop and begin overwriting the oldest data when logging memory is full.

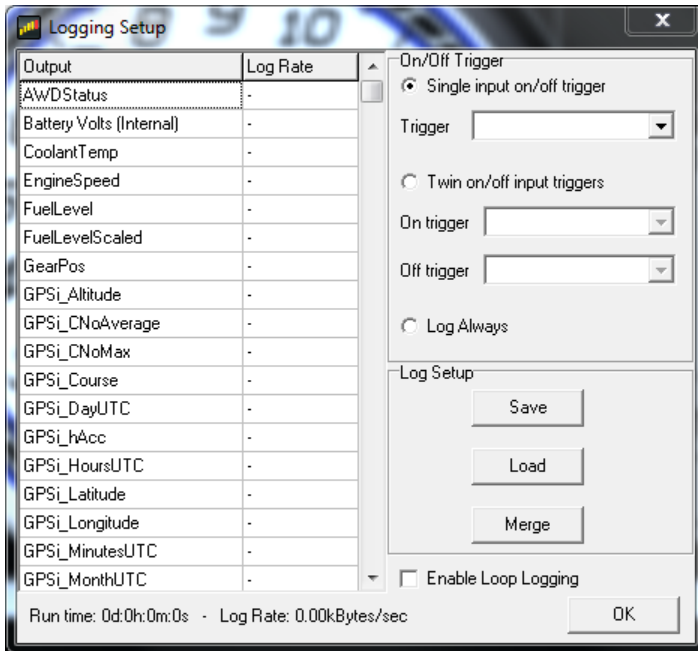

Special Logger Outputs

Enabling logger adds the following special outputs:

- **Log Mem Total** - The total logging memory in kilobytes
- **Log Mem Free** - The amount of logging memory remaining in kilobytes
- **Log Mem Percent Free** - The percentage of logging memory free.
- **Log Status** - A channel representing the current logging status:

The Log Status text has the following meaning:

- **Logging not Supported** - This firmware does not support logging.
- **Logging stopped** - The device is not currently logging.
- **Logging running** - The device is currently logging.
- **Log looped** - The log has looped.
- **Log memory space low** - There is less than 5% of the log memory remaining.
- **Log memory full** - The logging memory is full and logging has stopped.
- **Log initialising** - The logger is currently processing the setup.
- **LOG SETUP ERROR** - There is a problem with the logger setup.
- **LOG OVERRUN** - The logger has been unable to write the log data to the memory. Either reduce the number of logged channels or reduce the complexity of the display screen.
- **Log memory worn** - There are a significant number of bad blocks in the flash memory. Logging will continue to work but capacity will be reduced.

Downloading Log Files

To download log files from an AEM logging dash, connect the USB cable between the dash and your PC. Launch AEMData analysis software and turn on the switched ignition power to the Dash. The message below will be displayed when AEMData detects a connection to the dash.

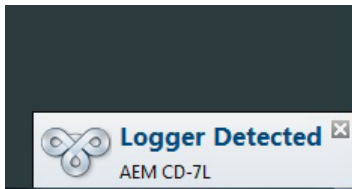

Go to **Logger** | **Download Log**

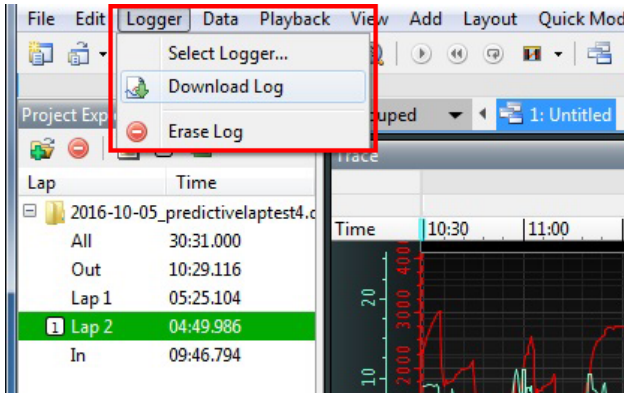

If there are logs saved on the dash, a list similar to the one below will be presented. Select the files to download. Choose whether to erase the files from the dash or not. The chronologically oldest log file will indicate "Looped" if loop logging was enabled and the file has been clipped. It will only contain data that hasn't yet been overwritten.

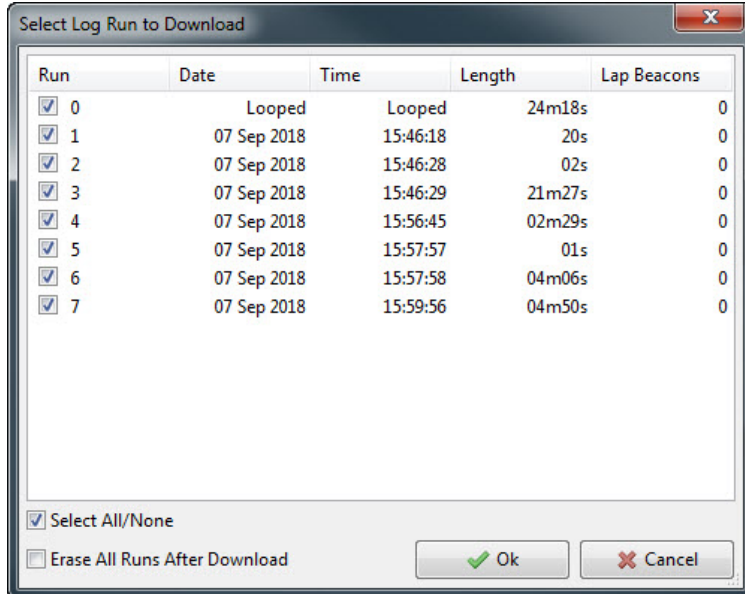

Setting the Internal Clock

- Connect the color display to your PC using the USB link..
- Select **Tools** | **Set Time and Date in Display**.
- The system will synchronize the time and date to match the PC.

Updating Dash Firmware

As part of the continuing development process, from time to time new versions of the AEM Dash firmware will be released with new DashDesign installers. To upload the new firmware:

- Firmware files are installed to the \Documents\AEM\DashDesign\Firmware folder.
- Connect the color display to your PC using the USB link..
- Select **Tools | Upload Firmware**. Select the firmware (.bin) file from the location above.
- The upload process starts. Do not switch the display off during the upload process as this may corrupt the firmware.
- Once the upload process has finished, unplug the USB cable to reboot the display.

The Setup Editor

The AEM DashDesign Setup Editor is used to configure the non-visual objects of a setup i.e. **Outputs** and **Operations**. Some outputs use more than one input depending on the operation used. The setup editor is accessed by selecting **Setup | Display...**

Each page of the editor has **Insert** and **Delete** buttons which are used to insert or delete an item in that tab. The following sections describe the various operation types available and how they are used to make an output.

Outputs

Outputs are values, texts or graphics that are used by gauges or other outputs. The output that it passes is determined by the operation that it uses.

To set up a new output:

- Click the Insert button in the Outputs tab.
- Enter the name of the new output. This should describe what the output actually generates.
- Select the operation to be used by the output from the drop-down list.
- Select the input from the drop down list.

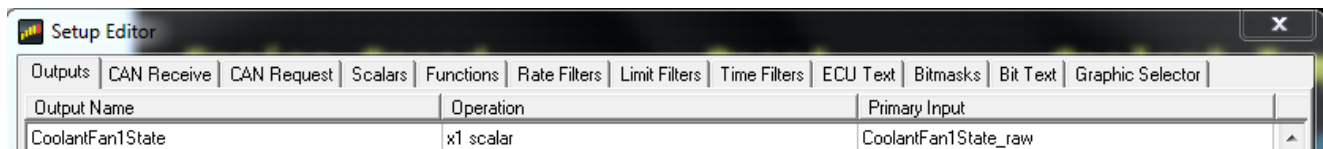

The example above shows the basic use of a x1 scalar. It uses a raw input and passes it through as itself with the opportunity to change the name.

CoolantFan1State = (CoolantFan1State_raw)*(1)

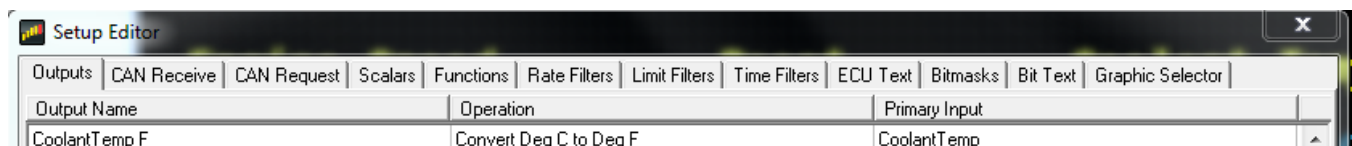

The next example shows a simple unit conversion operation.

Find the *Convert Deg C to Deg F* in the Scalars tab.

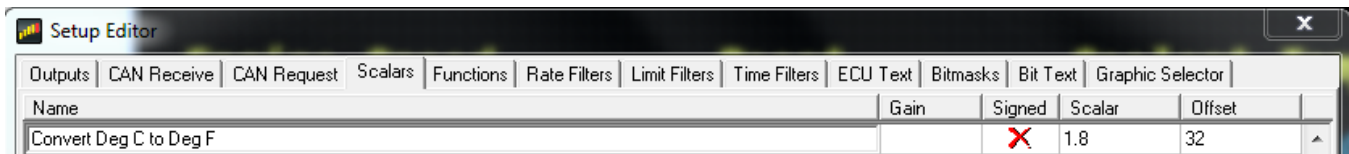

This Scalar operation uses a Scalar value of 1.8 and an offset value of 32. Applying this Operation results in the following math expression.

$$\text{CoolantTemp F} = (\text{CoolantTemp} * 1.8) + 32$$

This is a simple unit conversion for converting degrees C to degrees F.

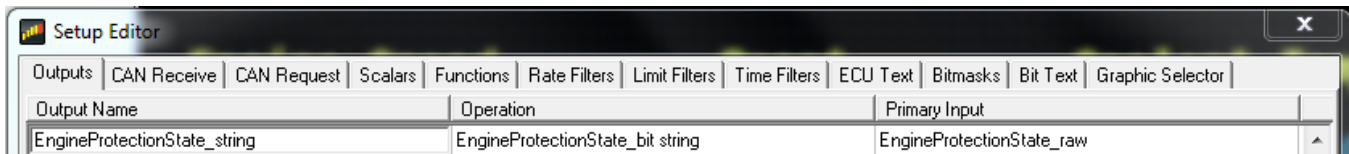

The next example uses EngineProtectionState_raw as the Primary Input. This input has two possible values with are 0 or 1. A Bit text operation is used to convert these values into text texts that can be displayed on the dash.

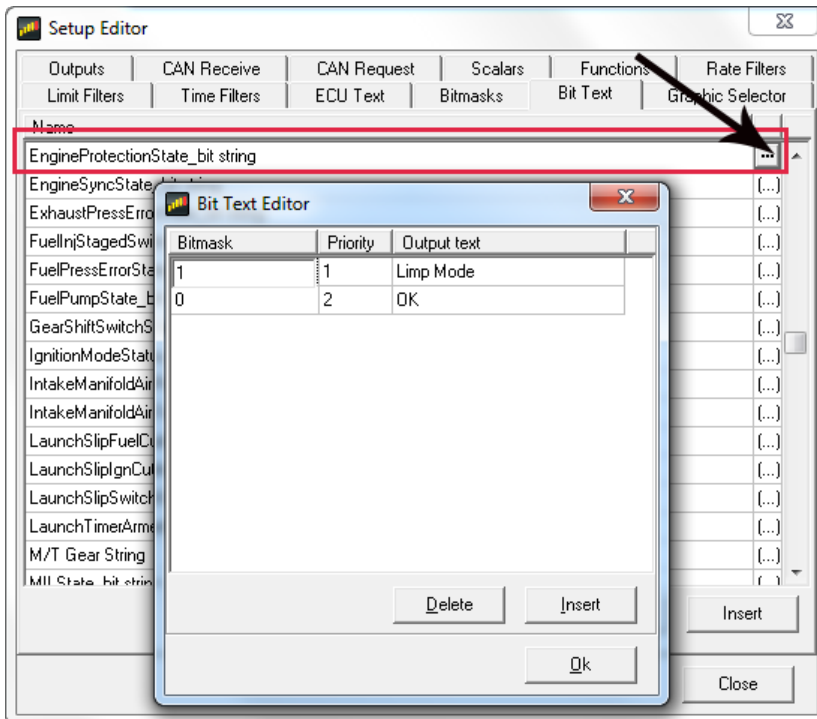

Shown above, the Bit text operation performs the following transformation:

If EngineProtectionState_raw = 1, EngineProtectionState_text = Limp Mode

If EngineProtectionState_raw = 0, EngineProtectionState_text = OK

CAN Receive

The Dash is a CAN display dash. The CAN receive tab of the Setup Editor must be defined for proper functionality. The steps involved in defining a CAN message structure from scratch is outside the scope of this manual. However, the system includes a robust CAN .dbc import feature that greatly simplifies the process.

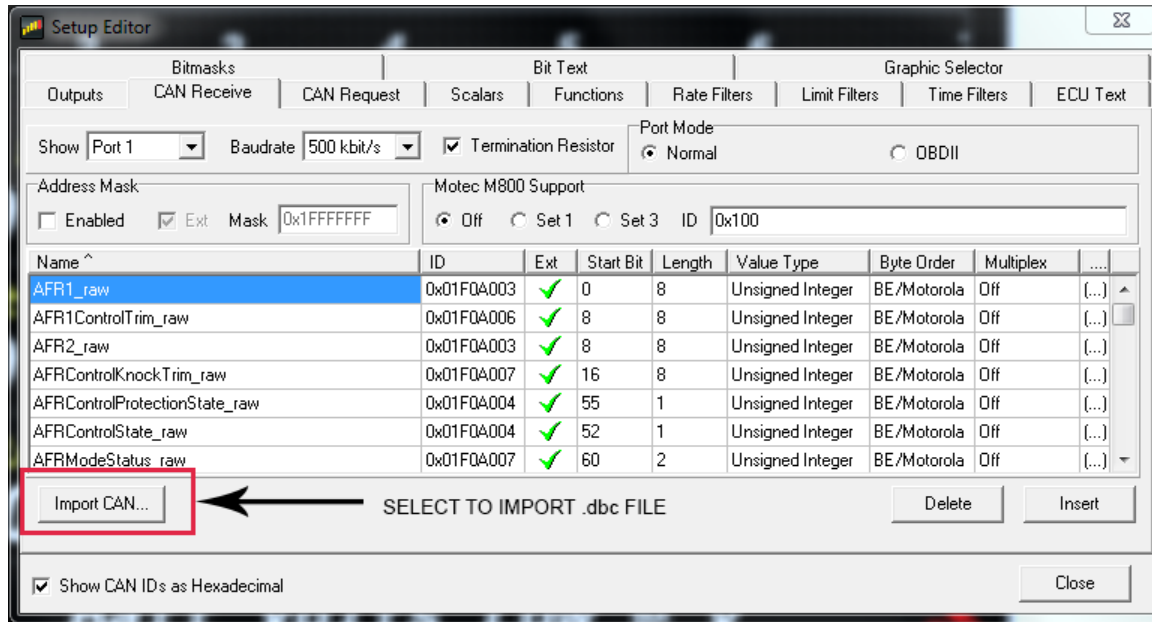

The "Start Bit" refers to the location of the LSB. The message contents and the byte/bit numbering can be viewed by clicking on the ... button for each message.

CAN message layout for id 0x01F0A000 Extended

Channels on message id 0x01F0A000 Extended

Name	Start Bit	Length	Value Type	Byte Order	Multiplex
CoolantTemp_raw	56	8	Signed Integer	BE/Motorola	Off
EngineLoad_raw	24	16	Unsigned Integer	BE/Motorola	Off
EngineSpeed_raw	8	16	Unsigned Integer	BE/Motorola	Off
IntakeManifoldAirTemp_raw	48	8	Signed Integer	BE/Motorola	Off
ThrottlePos_raw	40	16	Unsigned Integer	BE/Motorola	Off

Quick set data type and size Int16 0 BE/Motorola

CAN Message Layout

Byte	Channel Name	Start Bit	End Bit	Start Bit	End Bit	Start Bit	End Bit	Start Bit	End Bit	Start Bit	End Bit	Start Bit	End Bit
Byte 0	EngineSpeed_raw	7	6	5	4	3	2	1	0				
Byte 1		15	14	13	12	11	10	9	8				
Byte 2	EngineLoad_raw	23	22	21	20	19	18	17	16				
Byte 3		31	30	29	28	27	26	25	24				
Byte 4	ThrottlePos_raw	39	38	37	36	35	34	33	32				
Byte 5		47	46	45	44	43	42	41	40				
Byte 6	IntakeManifoldAirTemp_raw	55	54	53	52	51	50	49	48				
Byte 7	CoolantTemp_raw	63	62	61	60	59	58	57	56				

Multiplexor Value 0

Cancel OK

Scalars Operation

The scalar sensor applies a gain (if specified) to the input which is then multiplied by the scalar and the offset added. If signed is ticked and the gain is not set to NONE, the input is treated as a twos compliment number. The scalar sensor is used for linear signals.

Setup Editor

Name	Gain	Signed	Scalar	Offset
AFR1_scalar		<input checked="" type="checkbox"/>	0.00390625	0.5
AFR1ControlTrim_scalar		<input checked="" type="checkbox"/>	0.5	-64
AFR2_scalar		<input checked="" type="checkbox"/>	0.00390625	0.5
AFRControlKnockTrim_scalar		<input checked="" type="checkbox"/>	0.001	0
AFRControlTrim_scalar		<input checked="" type="checkbox"/>	0.5	-64
AFRTarget_scalar		<input checked="" type="checkbox"/>	0.00390625	0.5
AmbientAirTemp_scalar		<input checked="" type="checkbox"/>	1	-50
AntilagBoostTarget_scalar		<input checked="" type="checkbox"/>	0.1	0
AntilagEngineSpeedFuelTarget_scalar		<input checked="" type="checkbox"/>	100	0
AntilagEngineSpeedIgnTarget_scalar		<input checked="" type="checkbox"/>	100	0
BaroPress_scalar		<input checked="" type="checkbox"/>	0.25	50
BoostControlOutput_scalar		<input checked="" type="checkbox"/>	0.392157	0
BoostControlPIDOffset_scalar		<input checked="" type="checkbox"/>	0.392157	0
BoostControlTarget_scalar		<input checked="" type="checkbox"/>	0.1	0
BrakePress_scalar		<input checked="" type="checkbox"/>	0.006895	0
CamFueledRank1Pos_scalar		<input checked="" type="checkbox"/>	0.5	-50

Delete Insert

Close

Functions Operation

The function table sensor is used when a non-linear signal needs to be processed. The function table sensor applies a gain (if specified) to the input and looks up the input in the function table to produce the appropriate output. If the input falls between two values, linear interpolation is used to derive the output value unless the Interpolate Between Input Values check box is unchecked.

To edit the function table, click the ellipsis button (...) to show the function table editor:

Ensure there are no duplicate inputs as this may result in abnormal behavior.

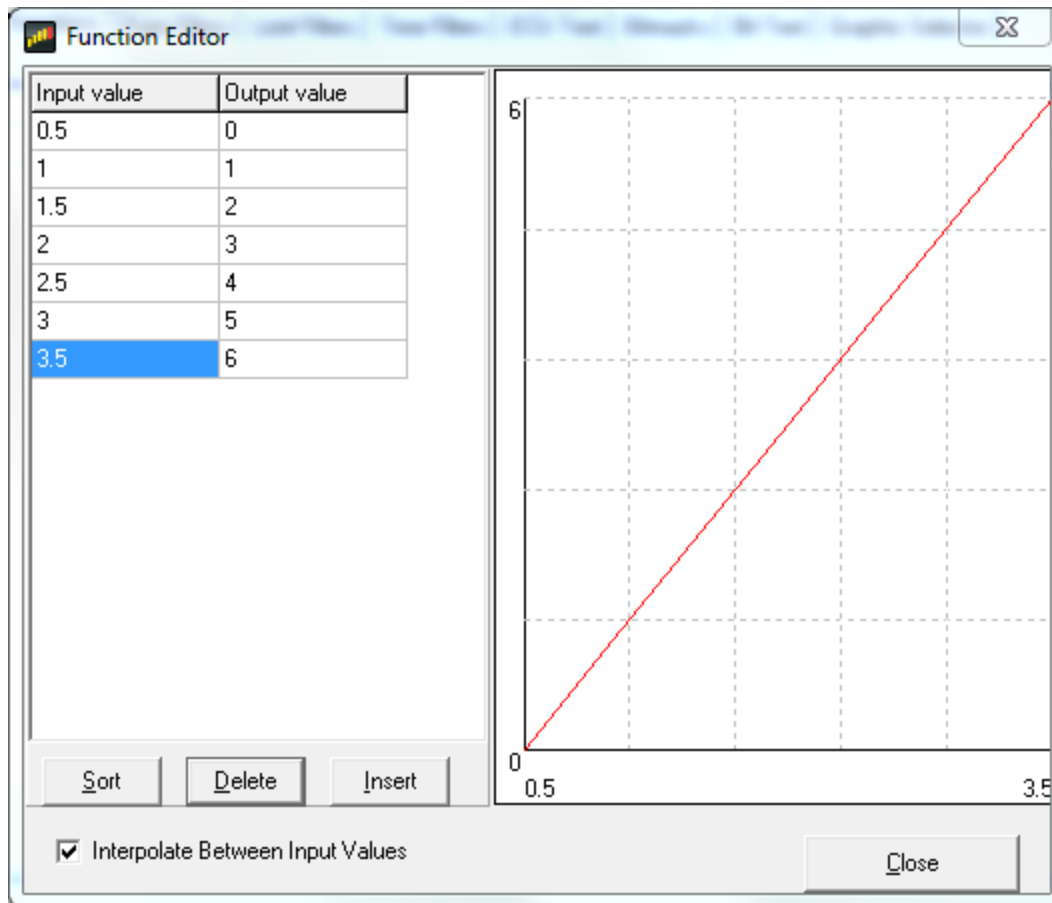

Rate Filters Operation

An output using a rate filter checks that the rate of change of the input value does not exceed a specified amount. If the rate of change is too high the new data is discarded.

Limit Filters Operations

An output using a limit filter checks that an input value never exceeds specified levels, either high or low. This can be used to prevent invalid data from reaching other outputs or gauges. If data is received that exceeds either of the high or low values (if specified) the data is discarded.

Time Filters Operation

Normally, outputs send data to gauges as fast as possible. However, by creating an output using a time filter operation, it is possible to specify the update rate of the output which is useful for making rapidly changing values more legible. Furthermore, a time filter operation can be used to perform a rolling average, minimum or maximum on the input value which is useful for filtering noisy inputs.

To edit the Time Filter operation values, click the ellipsis button (...) to show the time filter editor:

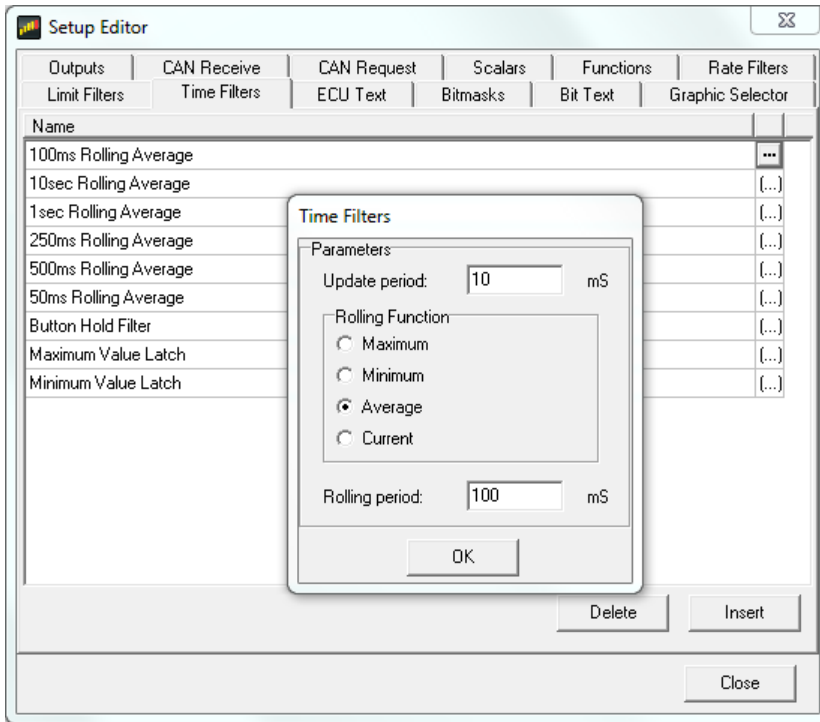

The Time Filter parameters have the following meanings:

- **Update period:** Specifies the rate at which values are sent to outputs and gauges used by this output. For example, if the Update Period is set at 1000, a gauge displaying the value from this output will update once per second. If 0 is specified, the output will update as fast as possible.
- **Rolling period:** Specifies the time period over which the rolling function is calculated. If zero is specified, the rolling period is set to the update period.
- **Rolling function:** Specifies how the value produced from the output is calculated:
 - **Maximum:** The output is the maximum value occurring during the last (rolling period) milliseconds.
 - **Minimum:** The output is the minimum value occurring during the last (rolling period) milliseconds.
 - **Average:** The output is the average of all values occurring during the last (rolling period) milliseconds.
 - **Current:** The output is the last received value. This effectively disables the rolling period function.

ECU Text Operation

An output using an ECU Text operation is used to obtain text (such as a calibration name) from the connected ECU. The length of the text to obtain is specified in the length column.

Bitmasks Operation

The bitmask operation is used to mask off bits from a raw (32 bit) input. This is useful when data is received from the ECU that contains information for two different outputs. For example, the lower 4 bits of a value may be used to determine gear position while the upper 4 bits determine diff mode. The bitmask is specified as the sum of all the bits being masked.

Bit Text Operation

When an input has bits that are set dependant upon a mode in the ECU, it can be useful to convert this into a text output. The bit text operation takes the input and compares it with defined bitmasks. The bitmasks are compared in order of priority until the masked input is set or no more bitmasks are defined. If a masked input is set, the corresponding output text is passed out of the sensor. If no bitmask matches the input an empty output text is passed.

To create a bit text operation, add a name for the operation in the Bit text tab and click on the (...) button to show the bit text editor:

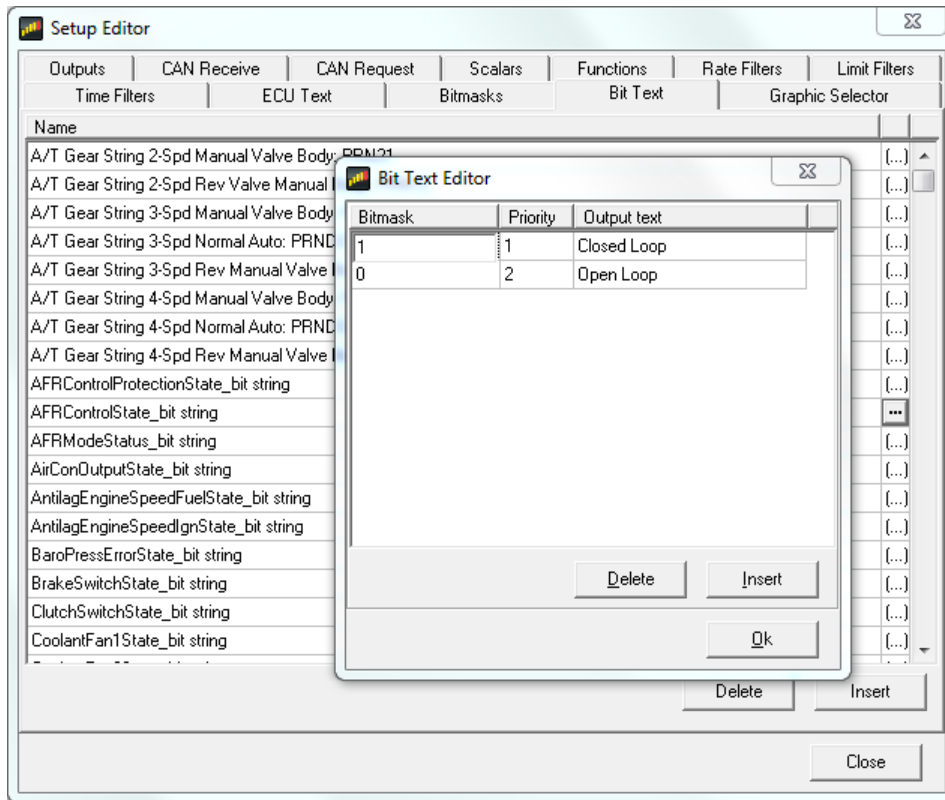

The priority determines the order in which the bitmasks are evaluated with low numbers being a higher priority. This ensures that if two bitmasks match, only the highest priority output text is returned from the sensor.

Graphic Selector Operation

The graphic selector operation is used to show different graphics depending on the value of an input. To create a graphic selector operation, add a name for the sensor in the graphic Sel tab and click on the (...) button to show the graphic selector editor:

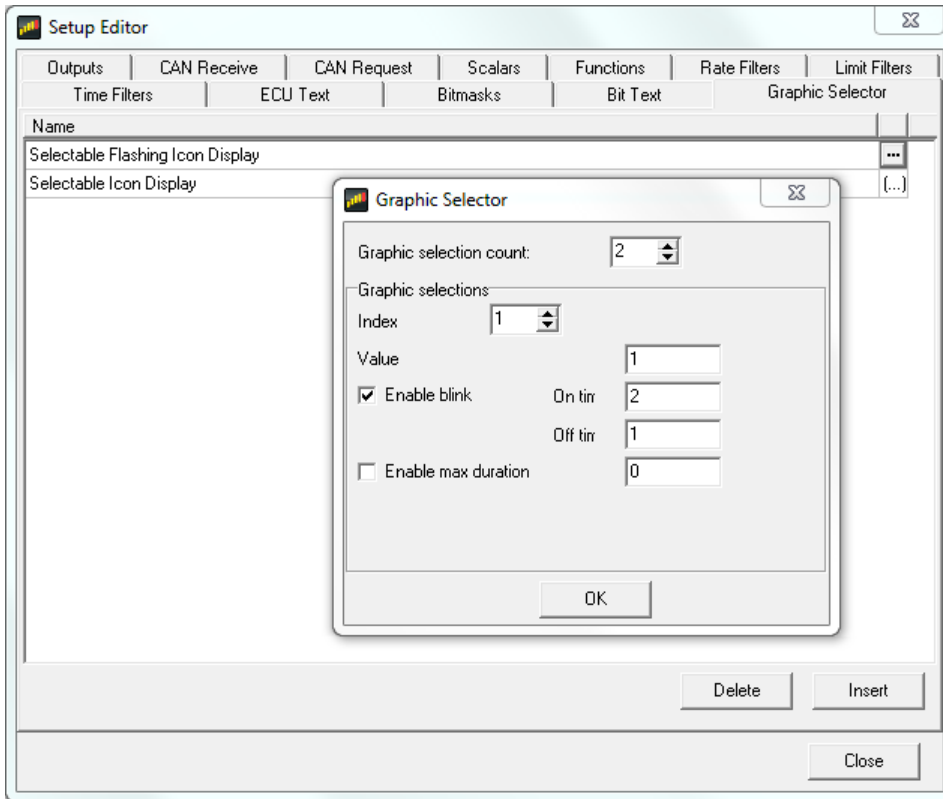



The graphic selection count is the number of graphics used in the sensor and is at least two. The first graphic is shown by default. Subsequent graphics are shown according to the settings in the graphic Selections box.

- **Index** - The number of the selection graphic for which the following settings are made. For example, if the selection count is set to 3, 1 will specify the first selectable graphic and 2 will specify the second selectable graphic.
- **Value** - When the input (specified in the output) is equal to this value, this graphic is shown instead of the default graphic.
- **Enable Blink** - If checked, this graphic will blink according to the **On Time** and **Off Time** in seconds. The graphic swaps between the indexed graphic and the default graphic.
- **Enable Max Duration** - If checked, the graphic is only be shown for the specified duration no matter how long the input is equal to the value.

Alarm Operation

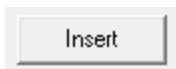
To create a new Alarm output, push the Insert button in the Outputs tab of the Setup Editor.



Assign the output a new name and choose *Alarm* from the dropdown list of available Operations. Push the  button under the Primary Input column for the new Alarm Output. This will open the Alarm Output Setup window. The new name will automatically be added to the Alarm Output Name box.

Input	Condition	Limit	Logic
	<	0	-

Alarm Output Name: Lean Warning

Delay Before Trigger / s: 0.00 Retrigger After / s: 0.00

Select an Input from the drop down list along with Condition and Limit selections.

Input	Condition	Limit	Logic
AFR1_Gas	>	15	-

Alarm Output Name: Lean Warning

Delay Before Trigger / s: 0.00 Retrigger After / s: 0.00

In the example above, the Input AFR1_Gas is checked against a maximum condition of 15:1 AFR. Click the Add button to add additional criteria.

Input	Condition	Limit	Logic
AFR1_Gas	>	15	AND
EngineSpeed	>	0	-

Alarm Output Name: Lean Warning

Delay Before Trigger / s: 0.00 Retrigger After / s: 0.00

Above, the input EngineSpeed is added as an "AND" condition with a limit of 0 RPM. With this logic, IF AFR1_Gas is greater than 15 AND EngineSpeed is greater than 0 (engine running), the alarm will trigger.

The Retrigger value specifies a timeout in seconds after which the alarm (if still triggered) will toggle to untriggered and back to triggered. This is useful for when an alarm has been used to trigger a page change, usually showing a warning to the driver, for example, low oil pressure. The driver can select the standard page again to cancel the alarm. If the oil pressure is still low after the specified period, then the warning page will be shown again.

If the retrigger value is set to zero, then the alarm will only retrigger if the input conditions change to false and back to true again.

The logical expressions are evaluated from top to bottom and the running result of the logical test is used as the input for the next logical evaluation.

Warning Message Operation

An output using a warning message operation is used to output warning messages when inputs are outside of the normal operating range.

- The warning input typically uses an output defined with an alarm operation. If the value of the output is non-zero, the associated warning message will be displayed.
- The label input is optional and is used to provide a value to be shown in the warning message.

The screenshot shows the 'Warning Input Editor' window. It contains a table with four columns: 'Warning Input', 'Warning Label', 'Label Input', and 'Label Input Format'. Below the table are fields for 'Warning Output Name', 'Warning Display Times' (On Time/s, Off Time/s, Min On Time/s), and buttons for 'Delete', 'Add', 'Cancel', and 'Ok'.

Warning Input	Warning Label	Label Input	Label Input Format
Warning Coolant Temp High	Coolant High @°F	CoolantTemp	###
Warning Batt Volts Low	Batt Volts Low @ v	ECUBatteryVoltage	#9.9

Warning Output Name: Warning Text Messages

Warning Display Times:
 On Time/s: 2.00 Off Time/s: 0.00 Min On Time/s: 2.00

The example above shows two existing Warning Inputs. These were both previously defined as Alarm outputs before setting up this window.

The Warning Editor message is entered in the Warning Label column. When an '@' symbol is inserted into the warning label a formatted input value from the label input replaces it in the display. The Label Input defines the data that replaces the '@' symbol. The input label format column allows the format of the value from the label input to be defined. For full details on value formatting, see [Value Formatting](#) in the gauge reference section.

If all the warning inputs are zero, the output text is empty. If only one warning input is non-zero, the appropriate warning is displayed. If multiple warning inputs are non-zero, the appropriate warning labels are displayed in turn, with each one being displayed for around a second.

The On Time, Off Time and Min On Time can be used to affect how the warning is displayed when only one warning is active and are scaled in milliseconds. For example, to have a single message flash at 2Hz, set the On Time to 1000 and the Off Time to 1000. Setting the Off Time to 0 disables flashing.

The Min On Time can be used to ensure a warning is visible even if it is only briefly triggered. For example, a low oil pressure alarm triggered during cornering may only occur for a fraction of a second but by setting the Min On Time to 2000 ensures that the message is displayed for 2 seconds and so is more likely to be seen.

Odometer and Turn Blinkers

AEM Dash has a built in odometer function. This is an internal counter backed up to non-volatile memory that cannot be reset (it is set to zero when the unit is built).

To set up the odometer, choose **Setup | Odometer**. Select an output that is road speed km per second. AEM DashDesign will automatically create an output called **ODOMETER** which is scaled in km and can be displayed on the screen.

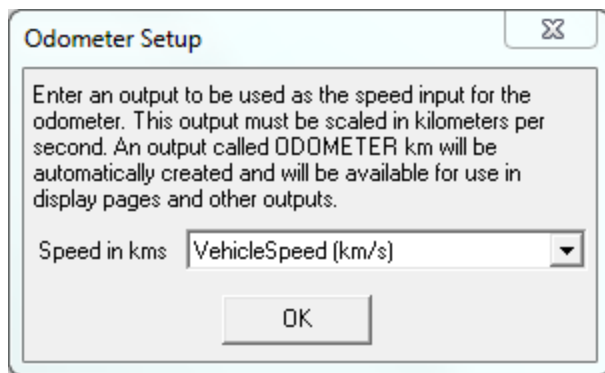

All AEM base setups include an odometer scaled in both miles and kilometers.

An optional turn blinkers feature is available on some AEM supplied setups. Pins 11 and 12 can be used for LEFT TURN and RIGHT TURN blinkers respectively. When these inputs are grounded, the turn blinkers will activate.

HARNESS 12 WAY CON PINOUT

PIN	COLOR	DESCRIPTION
1	RED	SWITCHED POWER
2	BLACK	GROUND
3	WHITE	CAN1+
4	GREEN	CAN1-
5	GREY	CAN2+
6	BLACK	CAN2-
7	BLUE	PAGE UP
8	YELLOW	RESET/ACK
9	GREY	NIGHT MODE
10	VIOLET	BEACON
11	NA	SPARE1
12	NA	SPARE2

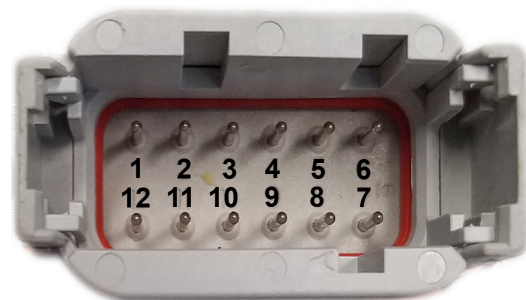

Lap Timing and Track Mapping

The following channels are used for lap timing and track mapping.

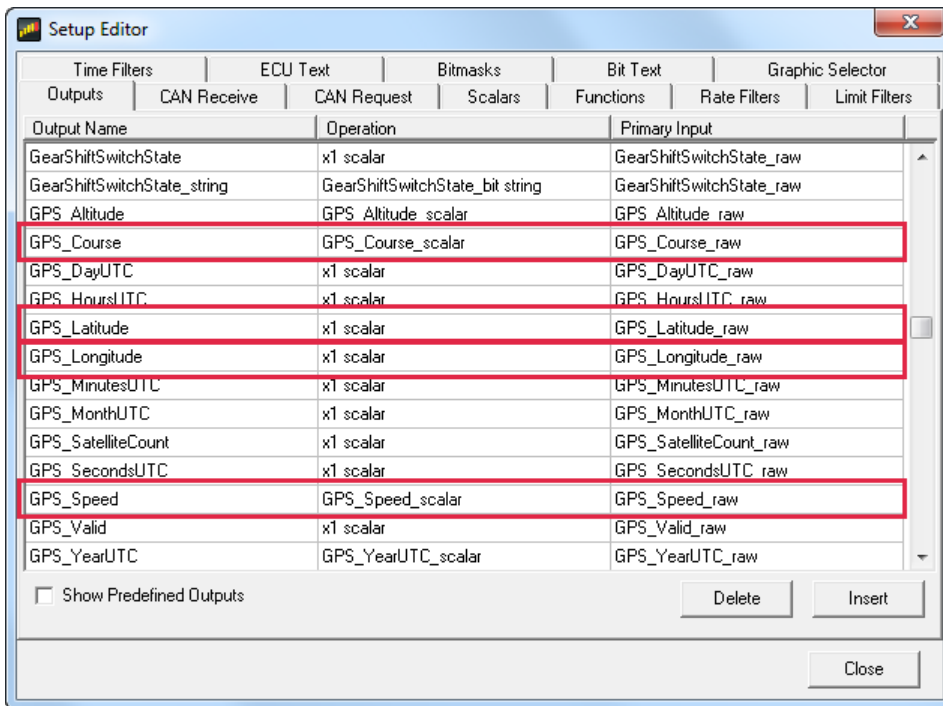

Most AEM default setups include a lap timing screen. The [VDM for GPS speed and lap timing](#) section describes the basic setup and configuration of a GPS input for speed and position. Once configured, the screen will update with current data as the laps progress.

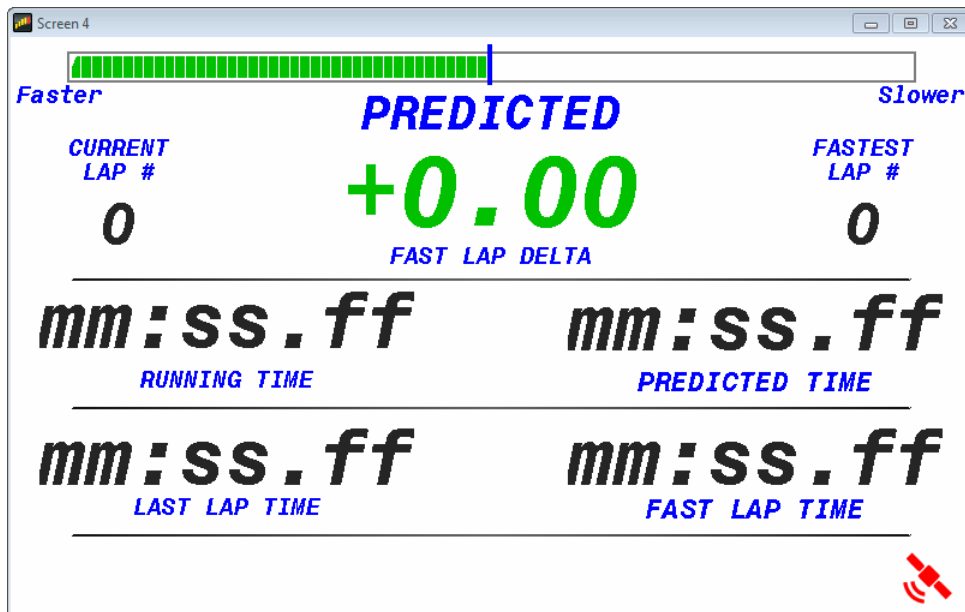

Lap Timing channels available include:

- Fastest lap number
- Fastest lap time

- Fastest lap average speed
- Fastest lap time delta (your current lap compared to the fastest lap)
- Last lap number
- Last lap time
- Last lap average speed
- Last lap time delta (your current lap compared to the last lap)
- Current lap number
- Current lap time

Go to **Setup | Lap Timing...** Select the GPS button to configure for GPS lap timing. A virtual start/finish line creation feature allows you to use the beacon input (violet wire in flying lead harness) to set a virtual start/finish line. While driving the course, press the momentary beacon switch when you cross the start/finish line. Hold for a few seconds until the left and right LEDs flash. The system captures the location information when you first press the button. Holding for a few seconds eliminates the likelihood of false triggering the input. You can define your virtual track width in the dialog window. Set to the approximate width of the track surface plus some extra. The dash creates a start finish line the width of the Track Width/m setting perpendicular to the heading when the start finish is set. It then checks whether the previous two points cross this line; the only caveat being that the heading is +/- 90 degrees of the original heading.

The GPS start/finish reference and fastest lap data is saved to non volatile memory in case the vehicle power is interrupted during operation.

A click and short hold on the right dash button will cause the left hand warning light to flash and will reset any count up, count down or lap timers except the fastest lap time and predictive lap data (if recorded). Holding the right button for 3 seconds or more will cause both warning lights to flash and will reset the fastest lap time and predictive data.

Once your file that contains GPS data is added to an AEMData project, you can add a track map to your project. Go to **Add | Track** and select a spot on your layout.

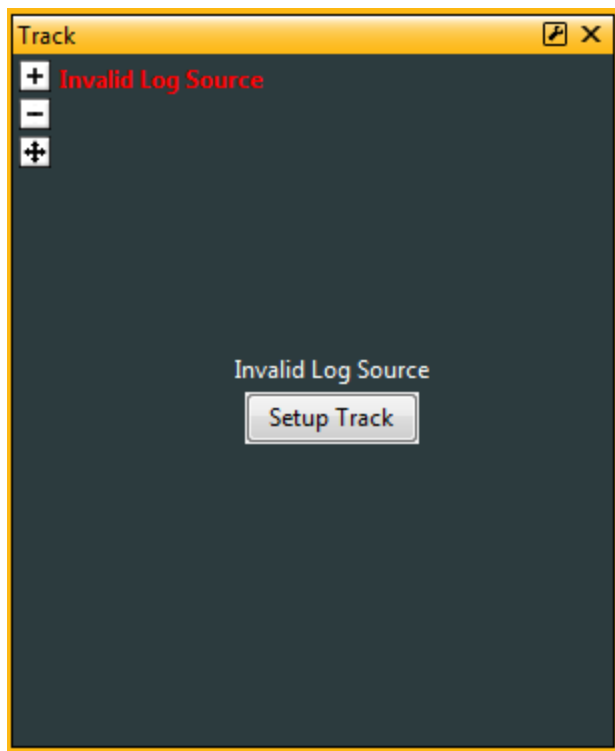

Click the Setup Track button and choose the GPS tab to configure your track.

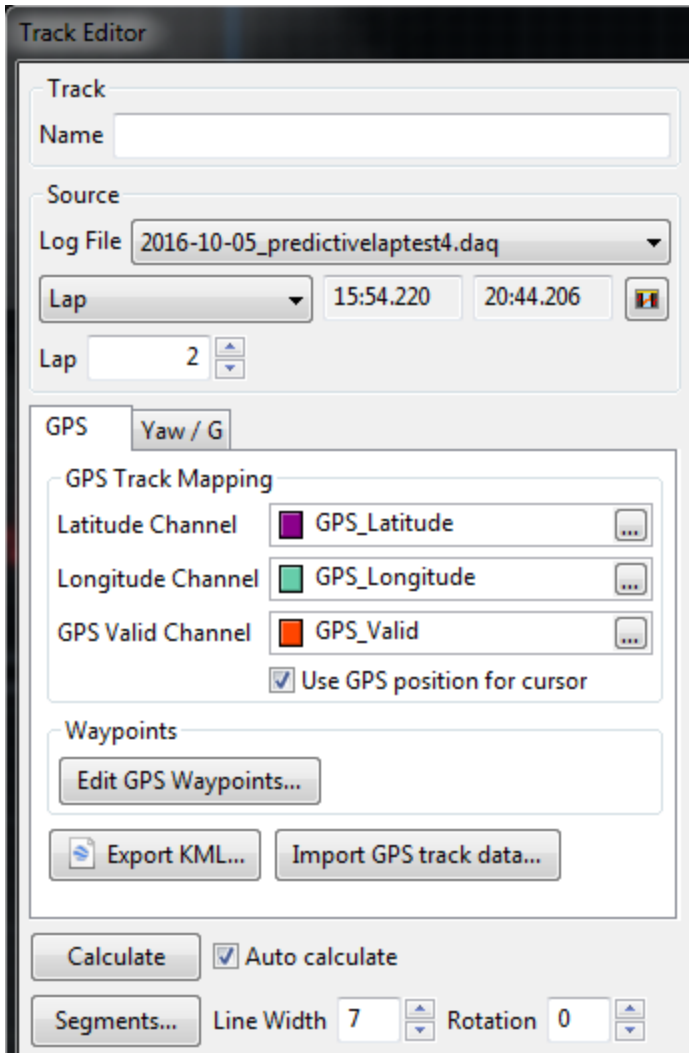

More details on Track Editing can be found in the AEMData documentation.

Settings

The Settings dialog will be populated correctly with all AEM supplied setup files. The options can be changed for custom setups. Night mode dialog box should be empty unless you want to control the mode via CAN. Default is empty and controlled by the flying lead harness input.

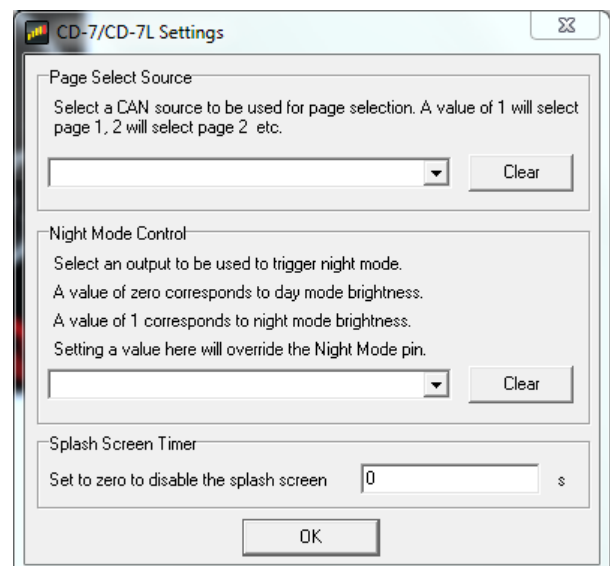

Shift Lights & LEDs

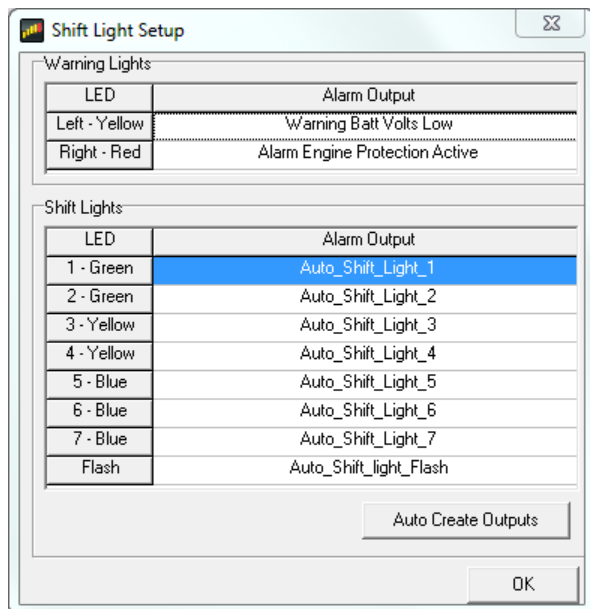

The LED and shift light setup will be pre-configured with AEM supplied setup files. The Alarm outputs used to trigger the LEDs can be adjusted in the Setup Editor as shown in the example below.

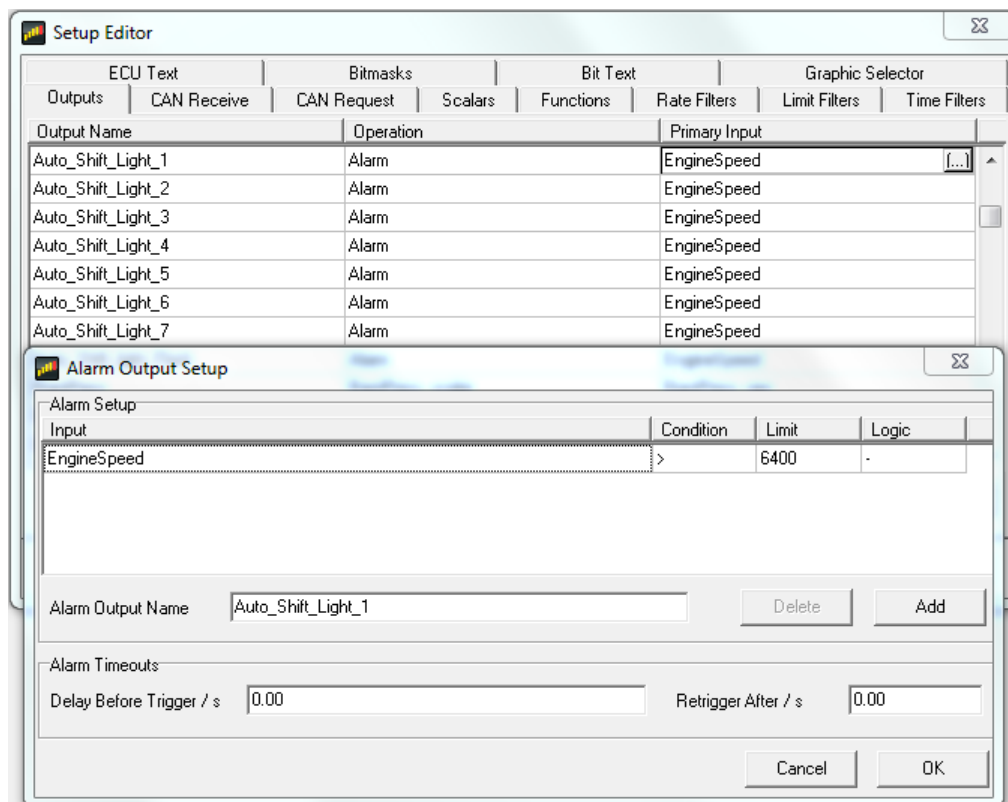

Alternately, the Auto Create Outputs feature can be used. Click this button and acknowledge the message shown below to continue.

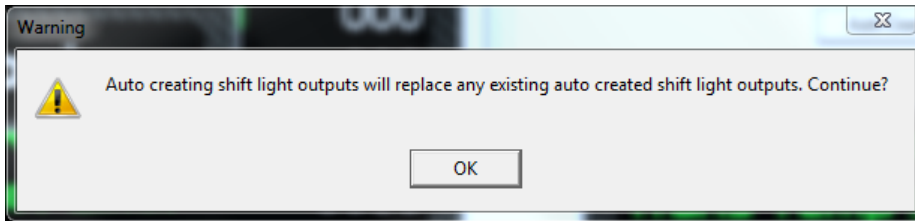

Select the output you want to use to trigger the warning lights. In the example below, we use Engine_Speed.

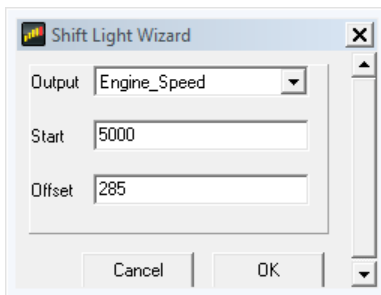

Select your start RPM and you can use the following calculation to set your offset.

$$\text{Offset} = (\text{End RPM} - \text{Start RPM})/7$$

For example if you want to start at 5000 RPM and end at 7000 RPM:

$$\text{Offset} = (7000-5000)/7 = 285$$

Alarm Page

AEM setups will come pre-configured with many optional Alarm outputs. Choose the ones you want to trigger the Alarm Page.

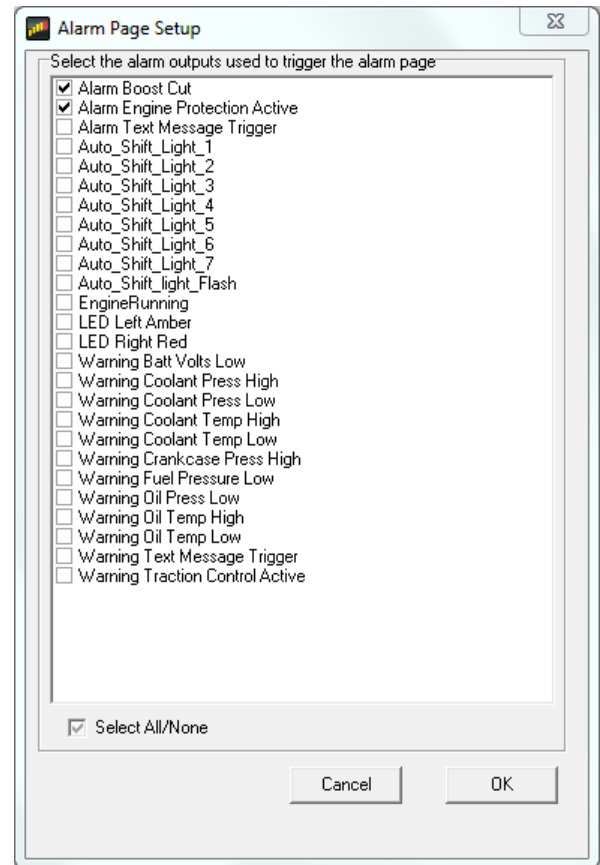

On Change Page

The On Change Page allows you to setup a custom page that will be displayed when any changes are detected on selected channels. The list of available channels will be displayed at the left. Double click or press the space bar to move them to the right Selected Channels list.

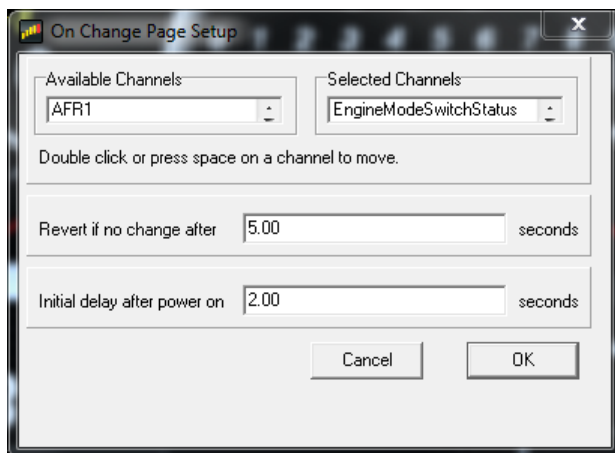

The example below shows one version of an AEM supplied On Change Page. Different operating modes and/or multi-map selections can be displayed using this page. Other useful items are boost target and traction controls set points.



Brightness

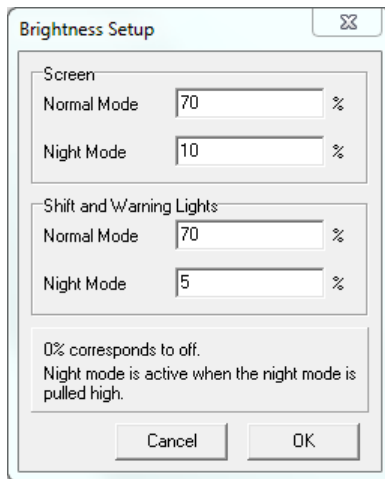

The Brightness setup dialog allows you to choose two different brightness settings for both the screen and LEDs. See [Harness and Wiring](#) section for Night Mode input wiring. 100% should only be used in direct sunlight. 70% gives almost as much brightness without overdriving the backlight. 5%-10% is appropriate for night mode. **NOTE: The LEDs used in the CD-5 unit are brighter and may require different settings compared to a CD-7 unit.**

Count Up and Count Down Timers

The output channels Count Up Timer and Count Down Timer are configured in the Setup Editor. In the outputs tab, check Show Predefined Outputs to display these channels for editing along with all other existing predefined channels. The output channel Count Up Timer can be added to a layout and set in msf format (minutes-seconds-hundredths). The Count Up Timer will increment continuously unless reset by pressing the right dash button. Count Down Timer can be added to a layout and configured in hmsf format (hours-minutes-seconds-hundredths). Click on the "... " button in the Primary Input column of the Outputs tab to edit the Count Down Timer reset values. The Count Down Timer will reset to its starting time by pressing the right dash button.

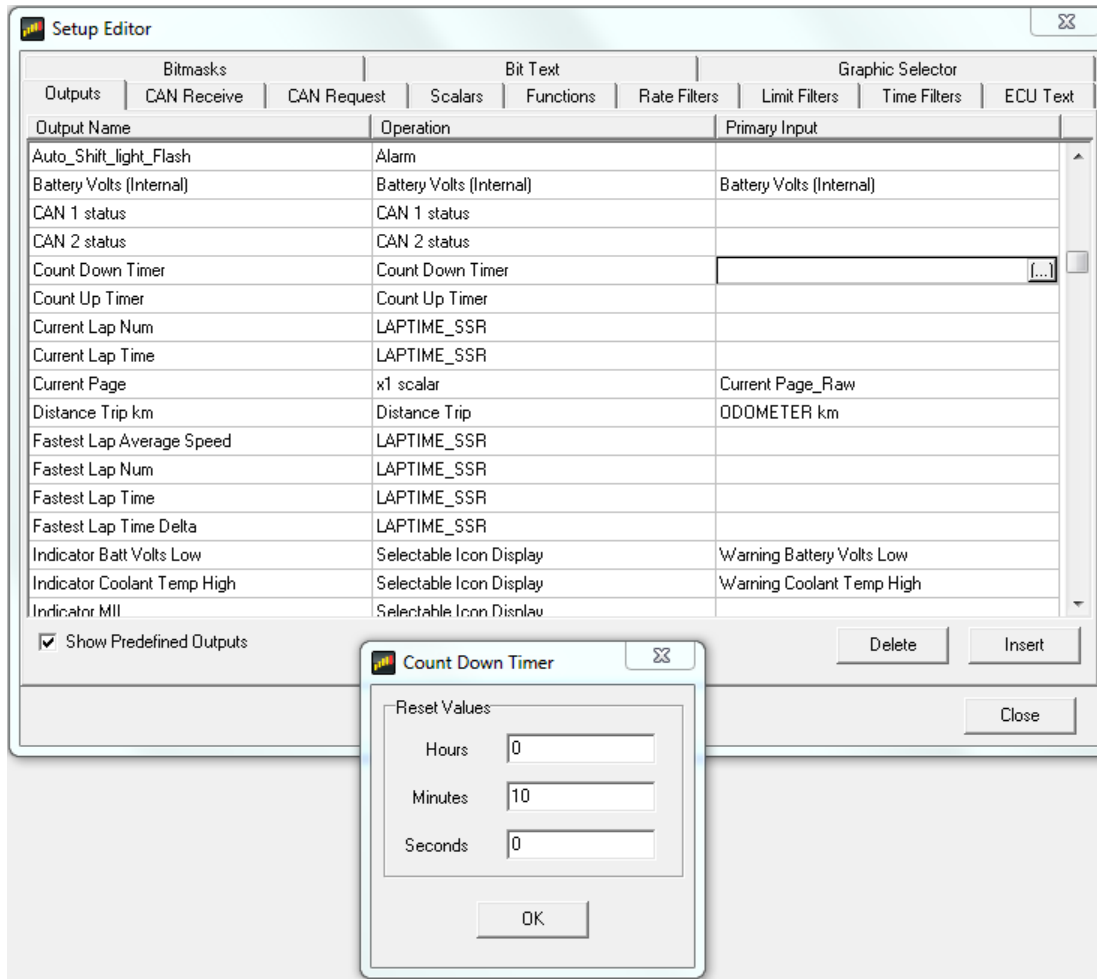

Display Screens

The AEM Dash supports 6 screen pages. The display also has a monitor list which enables permanent monitoring of data and a splash screen that appears when the display starts.

Display Scaling

By default, AEM DashDesign displays the screens at actual screen size (100%). For example, if the screen size of the hardware is 800x480 pixels, then the screen editor windows will also be 800x480. Editing in this mode provides a true what you see is what you get editing experience.

However, it is possible to show the editor windows at different scalings by selecting an appropriate value from the **Display | Display Scale** menu. Supported scales are 75%, 100% (default), 125%, 150%, 175% and 200%.

The Monitor Screen

Normally a given output is only monitored if used by a gauge on the currently displayed screen. In certain circumstances however, it is necessary to monitor some outputs irrespective of whether or not they are used by the currently displayed screen page. For example, if the maximum coolant temperature is required as an output for some screens, switching screens deletes the output as the screen changes and recreates it if necessary. The maximum output is then be reset and its' information is lost. By adding this output to the monitor page it is created when the color display is switched on. Changing screens has no effect on the output and the data is not reset unless a reset signal is received.

Furthermore, outputs added to the monitor screen are automatically stored in non-volatile memory. Thus, the value of a min, max or average output added to the monitor screen is preserved even when the screen is powered off.

Select **Display | Monitor** to view the monitor screen setup. Add the outputs to be continuously monitored to the list.

The Splash Screen

The splash screen is a special screen that is shown for a set period when the display starts; for showing a team logo for example.

To design the splash screen, go to **Display | Splash Screen** and design the screen layout as normal. Typically, this will just be a logo but other static values (such as the serial number or version details) will work as well.

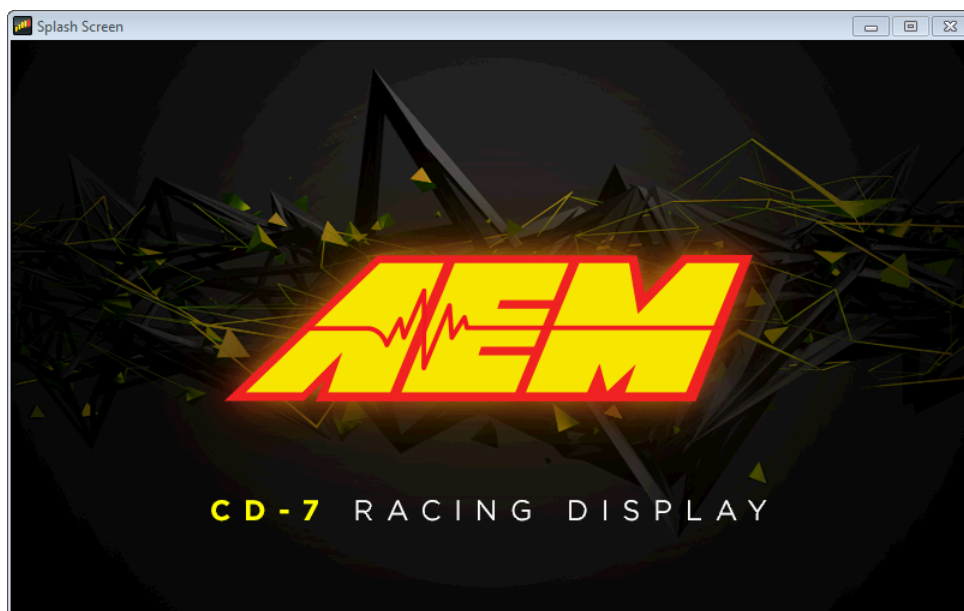

Setting Screen and Default Colors

The **color** menu allows the default colors to be specified. These are used whenever a new gauge is added to a screen. The default colors can be overridden in the individual gauge properties.

- **Screen** – Sets the background color of the current screen.
- **Warning** – Default color of a warning bar when it is triggered.
- **Gauge Background** – Default background color of a gauge.
- **Gauge Line** – Default line color of a gauge used in drawing the outline.
- **Gauge Fill** – Default fill color of a gauge used in bars.
- **Gauge Text** – Default text color of a gauge.

Adding a Gauge

Once a screen page is open, it is possible to add gauges to the screen. To add a gauge:

- Select the gauge required from the **Gauge** menu or the tool bar.
- Click on the area of the screen the gauge is to be added to and whilst holding the mouse button down drag a box to the size required for the gauge.
- On releasing the mouse button, the gauge will be added to the screen.

Most gauges can be added from the tool bar:

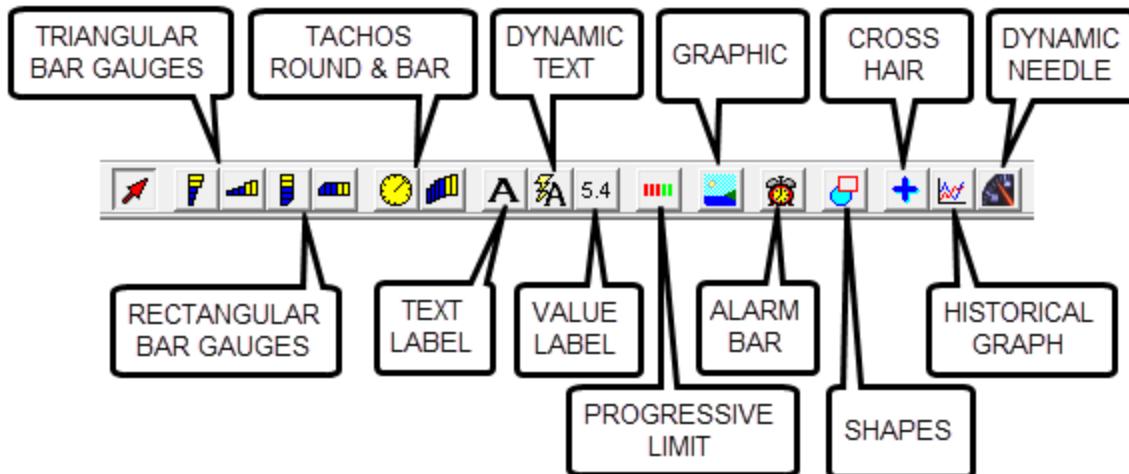

Selecting a Gauge

A gauge is selected using either the mouse or keyboard. To select a gauge using the mouse, move the cursor over the gauge. If gauges are overlapping the topmost gauge is selected. Try moving the mouse to an area where the gauge to select is not covered by another gauge. Alternatively, use the keyboard. To select a gauge using the keyboard press the tab key repeatedly until the appropriate gauge is selected. When a gauge is selected a border appears around it.

Moving a Gauge

A gauge can be moved using either the mouse or the edit window. To move a gauge using the mouse:

- Select the gauge with the mouse.
- When the cursor appears as a pointing hand  click and drag the gauge to the required position.



To move a gauge using the edit window:

- Show the [Gauge Property](#) window by right clicking on the selected gauge or by selecting it from the **Edit** menu.
- Change the values of the **x position** and **y position** properties to appropriate values.

This is particularly useful in aligning different gauges.

Resizing a Gauge

A gauge can be resized using either the mouse or the edit window. To resize a gauge using the mouse:

- Select the gauge with the mouse.
- Move the cursor to the border of the gauge which requires resizing. The pointing hand cursor changes to a sizing cursor depending on the position:
 - If the cursor is at the top left or bottom right corner of the gauge the cursor changes to a NW-SE cursor  and is resized by dragging that corner.
 - If the cursor is at the top right or bottom left corner of the gauge the cursor changes to a NE-SW cursor  and is resized by dragging that corner.
 - If the cursor is at the top or bottom edge of the gauge the cursor changes to a N-S cursor  and is resized by dragging that side.

- If the cursor is at the left or right edge of the gauge the cursor changes to an E-W cursor  and is resized by dragging that side

To resize a gauge using the edit window:

- Show the [Gauge Property](#) window by right clicking on the selected gauge or by selecting it from the **Edit** menu.
- Change the values of the **x size** and **y size** properties to appropriate values.

This is useful in making different gauges the same size.

Deleting a Gauge

To delete a gauge:

- Select the gauge.
- Press the *Delete* key.

Editing Gauge Properties

The gauge property editor is used to change the settings of an individual gauge. The gauge property editor is shown using either the mouse or **Edit** menu. Using the mouse:

- Select the gauge.
- Click the right mouse button.

To edit a gauge using the menu:

- From the **Edit** menu, select the name of the gauge to edit.

The gauge property editor is specific to the type of gauge being edited. See the [Gauge Reference](#) section for full details.

Using Copy and Paste

The copy and paste feature is used to copy gauges or entire screens between screen pages or setup files.

- **Edit | Copy | Gauge** copies the currently selected gauge into the paste buffer.
- **Edit | Copy | Screen** copies the current screen into the paste buffer.
- **Edit | Paste | Gauge** pastes the last gauge copied into the paste buffer into the current screen.
- **Edit | Paste | Screen** pastes the last screen copied into the paste buffer into the current screen. Any gauges already present on the current screen will be removed.

To paste a gauge or screen into a different setup file, copy it, close the file, open the appropriate setup file and screen and paste.

Setting the Gauge Z Order

When a page is rendered in the display, the gauges are drawn in the order in which they were added to the screen in the editor.

When gauges are placed on top of other gauges, it can be useful to change the order in which the gauges are drawn (the Z order). For example, if an alarm bar is added over a value gauge, only the alarm bar will be visible. By changing the Z order so that the value gauge is drawn after the alarm bar, the value gauge will appear drawn on the alarm bar.

To change the Z order on a page, select **Edit | Z Order...** or press **Ctrl Z**. The Z order editor will be shown. To change the order of a gauge, select it from the list (it will be simultaneously highlighted in the screen editor) and use

the up and down cursor keys or the up down buttons to move the gauge within the list. gauges towards the top of the list are drawn first (behind other gauges). Gauges towards the bottom of the list are drawn last (in front of other gauges).

Click OK to commit the changes or cancel to quit the Z Order editor.

Gauge Reference

Gauges are the visual elements of a AEM DashDesign screen page. The various different gauge types available in AEM DashDesign are described in this section.

Standard Gauge Properties

Most gauges share a standard set of gauge properties described below. In addition to these standard properties, many gauges have additional properties that are described in their relevant section.

The standard gauge properties are as follows:

- **Name** - The name is used to identify the gauge in the **Edit** menu. The AEM CAN Dash assigns a name to a new gauge automatically although it is useful to give gauges more meaningful names as it makes them easier to identify in the **Edit** menu.
- **Input** - The output used by the gauge.
- **Minimum** - The value at which a gauge starts, for example the start value of a bar gauge.
- **Maximum** - The value at which a gauge finishes, for example the end value of a bar gauge.
- **Resolution** - Divisions are drawn at this frequency.
- **Label Frequency** - Labels are drawn according to the resolution.
- **Label Font** - The font used by the gauge.
- **Label Font Size** - The font size used by the gauge.
- **Label Format** - Determines how numbers are formatted in the gauge. See the [Value Formatting](#) section for more information.
- **X Position** - The left most position of the gauge.
- **Y Position** - The top most position of the gauge.
- **X Size** - The width of the gauge.
- **Y Size** - The height of the gauge.
- **Background color** - color of the gauge background.
- **Line color** - color of the resolution lines and outline of the gauge.
- **Fill color** - color in which to draw a filled part of the gauge, for example the part of a bar graph that has data.
- **Text color** - color of all text in the gauge.

Value Formatting

Many gauges can use a **Label Format** property in order to control how values are displayed. The following table shows the standard formatting characters that can be used.

Character	Description	Notes
X or x	Display in hexadecimal	Must be first character in format
B or b	Display in binary	Must be first character in format
-	Force leading sign character	e.g. +5.3 is displayed instead of 5.3
#	Indicates an optional digit	e.g. ### gives 93
9	Indicates a required digit	e.g. 999 gives 093
5	Indicates rounding to the nearest 5	e.g. ##5# gives 2450 instead of 2448
0	Indicates rounding to the nearest 10	e.g. ##0# gives 2400 instead of 2448
.	Indicates position of decimal place	

Gauges using time outputs use a different set of format texts:

- H - Displays the hours in 24 hour format.

- h - Displays the hours in 12 hour format.
- m - Displays the minutes.
- s - Displays the seconds.
- f - Displays tenths of seconds.
- ff - Displays hundredths of seconds.
- fff - Displays thousandths of seconds (only works for lap time via CAN).
- y - Displays the date in dd-mm-yy format
- z - Displays the date with text for the month, eg 01 Jan 09

Thus, the following formats would display the time in the following manner:

- Hms - 24:00:00
- hmsf - 12:00:00.0
- hmsff - 12:00:00.00
- y - 01-01-09
- hmsz - 12:00:00 01 Jan 09

System information can be shown by adding a value gauge to the screen and setting the **Label Format** property as follows:

- W - Shows the version of the color display firmware.
- vs - Shows the serial number of the display.
- vu - Shows the usage (on time) of the display in hours.
- vr - Shows the reset counter - the number of power on events since the last setup upload.
- vc - Shows the filename of the setup file used to program the display (up to 24 characters).

Bar Gauges

There are four types of bar gauge - rectangle and triangle shaped bars in either horizontal or vertical orientation. A bar contains a number of resolution lines that divide the bar up between the minimum and maximum limits.

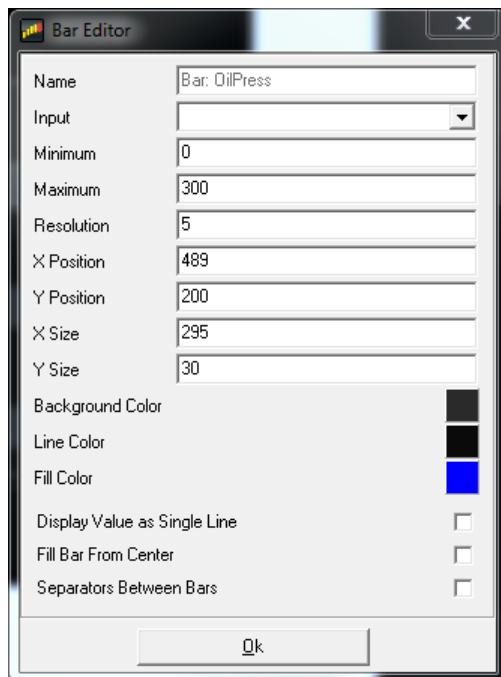

Tacho Gauges

The tacho gauges are typically used with engine speed or road speed and are available as either a curved bar gauge or a round gauge. They use minimum, maximum and resolution in the same manner as bars but also have labeled resolution lines, the frequency of which is specified by the label frequency property. The label values are divided by the label divisor property and then formatted.

This bar tacho gauge has the following special properties:

- **Square Tacho** - If checked, the tacho will be rectangular instead of having an arc.
- **Enable Lower Tacho Limit** - Turns on the lower tacho limit. When enabled, the first part of the tacho (up to **Limit End**) is drawn in **Limit color** as it is filled. If **Enable Flash Below Limit** is checked, the lower part of the tacho will flash if the input value is below **Limit End**.
- **Enable Tacho Limit** - Turns on the upper tacho limit. When enabled, the last part of the tacho (after to **Limit Start**) is drawn in **Limit color** as it is filled. If **Enable Flash Above Limit** is checked, the upper part of the tacho will flash if the input value is above **Limit Start**.
- **Flash Entire Tacho above Limit** - If the upper limit is flashing because **Enable Flash Above Limit** is checked, all the filled tacho blocks will flash if this option is checked.
- **Flash Rate** - The rate at which to flash the tacho when in any of the flash modes.

It can be seen that with these options, the tacho can effectively be divided into three separate different colored regions.

Bar Tacho Editor

Name: BarTacho - Engine RPM

Input: Engine_Speed

Minimum: 4000

Maximum: 9000

Resolution: 100

Label Frequency: 10

Label Font: Sui Generis

X Position: 15

Y Position: 5

Background Color: [Black]

Line Color: [Black]

Appearance:

- Square Tacho
- Smooth
- Separators Between Bars

Label Divisor: 1000

Label Format: #

Label Font Size: 30

X Size: 770

Y Size: 195

Fill Color: [Yellow]

Text Color: [White]

Lower Limit Options:

- Enable Lower Tacho Limit
- Limit End: 8000
- Limit Color: [White]
- Enable Flash Below Limit

Upper Limit Options:

- Enable Tacho Limit
- Limit Start: 8600
- Limit Color: [Red]
- Enable Flash Above Limit
- Flash Entire Tacho above Limit:
- Flash All Start: 8800

Flash rate (between 100 and 500 ms): 500

Ok

Text Label Gauge

The Text Label gauge is a static gauge (it has no input) that is used to label other gauges and provide static information to the user. The text displayed in the gauge is set in the **Text** property. The **Direction** property is used to specify the direction in which the text is drawn in. *Right* specifies left to right. *Down* specifies top to bottom.

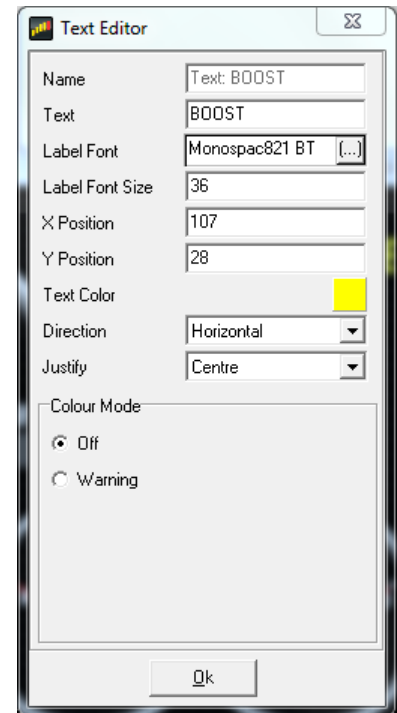

Variable String Gauge

The variable text gauge is used to display text from a text output such as a bit text output. The **Justification** property specifies whether the text is aligned to the left, right or centre of the bounding rectangle.

Note: It is important to select the background color of the value gauge to be the same as the color of the background the gauge is over. Failure to do so will result in corruption of the value displayed.

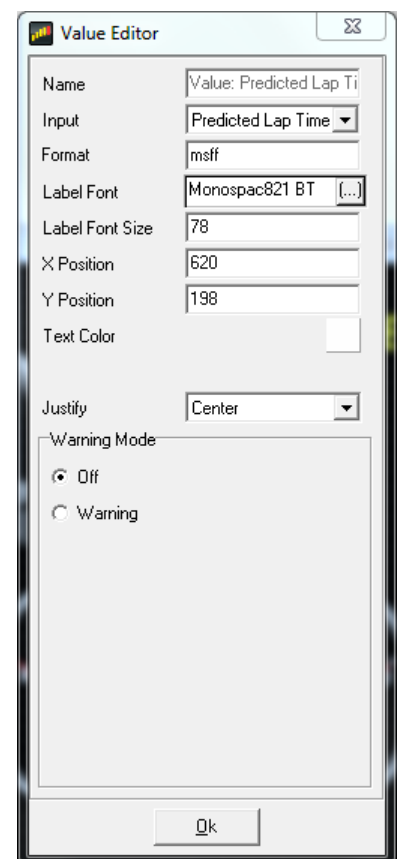

Value Gauge

The Value Gauge shows the value of the output specified in the **Input** property according to the [format](#) specified in the **Format** property. The **Justification** property specifies whether the text is aligned to the left, right or centre of the bounding rectangle.

Note: It is important to select the background color of the value gauge to be the same as the color of the background the gauge is over. Failure to do so will result in corruption of the value displayed.

The value gauge has an optional warning mode that changes the color of the gauge when a warning limit for the input is exceeded. To activate warning mode, check the **Warning Mode Active** box and specify the **Warning color**.

- To have the warning activated when the value of the input goes above a certain value, click the **Input Limit Exceed** button and enter a value for the **Warning Limit**. The displayed data will change from the **Text color** to the **Warning color** when the input value is greater than or equal to the **Warning Limit**.
- To have the warning activated based on a secondary input, click the **Secondary Alarm Output** button and select the output to be used as the trigger. The displayed data will change from the **Text color** to the **Warning color** when the secondary input value is non-zero.
- If **Flash If Warning Active** is checked, the gauge will alternate between the warning color and the background color whilst the warning is active.

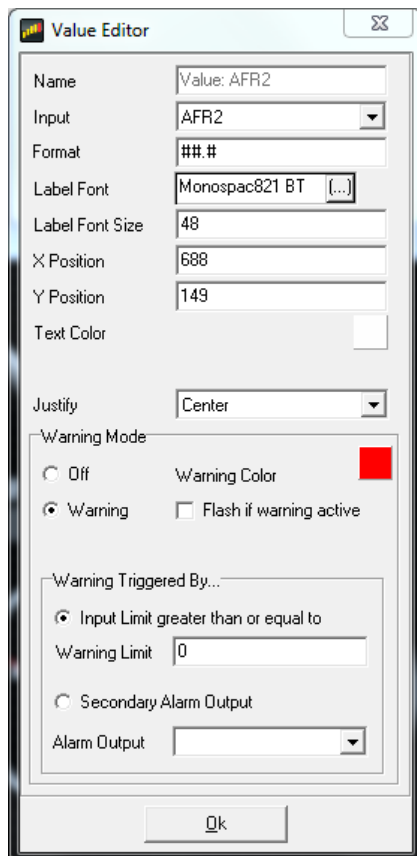

The screenshot shows the 'Value Editor' dialog box with the following settings:

- Name: Value: AFR2
- Input: AFR2
- Format: ###
- Label Font: Monospac821 BT
- Label Font Size: 48
- X Position: 688
- Y Position: 149
- Text Color: (empty)
- Justify: Center
- Warning Mode: Warning
- Warning Color: (red square)
- Flash if warning active:
- Warning Triggered By...: Input Limit greater than or equal to
- Warning Limit: 0
- Secondary Alarm Output:
- Alarm Output: (empty)

Buttons: Ok

Progressive Limit Gauge

The Progressive Limit gauge is typically used to signal an approaching rev limit by means of several boxes that change color as the rev limit approaches. This gauge has the following special properties:

- **Box Count** is the number of boxes in the gauge.
- **Box Size** is the width and height of the box in pixels.
- **Limiter Start** is the value at which the first box will change color from **Background color** to **Fill color**.
- **Limiter Offset** is the value added to the **Limiter Start** to determine when the next box changes color.
- **Draw Circular Limit Lights** - if checked, round LED style boxes will be drawn instead of boxes.

For example, if **Box Count** is 3, **Limiter Start** is 8000 and **Limiter Offset** is 200, the first box will change color at 8000, the second at 8200 and the third at 8400.

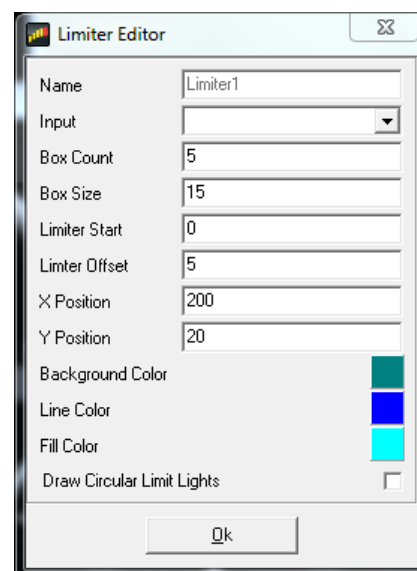

Graphic Gauge

The graphic gauge is used to show a graphic from a file or the output of a [graphic selector](#) output. The **graphic** property has a drop down box from which any [graphic selector](#) outputs and graphics currently present in the setup is selected. At the bottom of the list is the option **Add New graphic** which is used to add a new graphic from a file to the list. graphics must conform to the Microsoft Windows graphic standard and should be no bigger than 800x480 pixels. The graphic can be true color (32 bit) though lower definition graphics may be preferable to reduce the size of the setup.

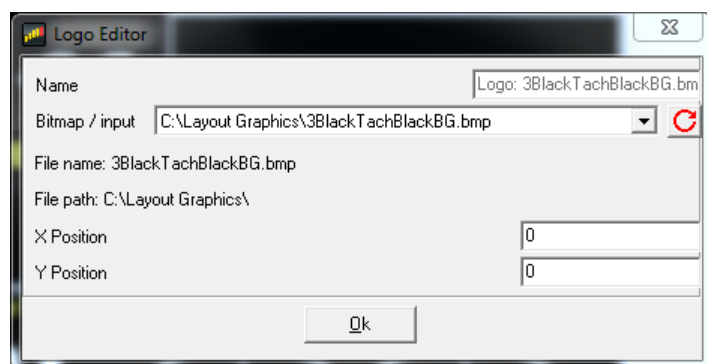

Alarm Bar Gauge

The Alarm Bar gauge is a block that changes color depending on its input. Typically this is used to indicate out-of-range parameters. For example, an Alarm Bar may be placed next to a gauge showing coolant temperature. The input to the Alarm Bar is configured to give an error signal if the coolant temperature rises above a pre-determined level. The bar color changes from the specified background color to the Fill color to give an easily seen warning indication.

Starting in firmware version 14x20, the Alarm Bar function has been updated to use pre-configured color mapping for dynamic color changes instead of having to manually map out specific color bit values as was done in previous versions. The following describes the new method of configuring an Alarm Bar. The older method will follow for reference.

For firmware version 14x20 and newer:

Alarm Bar Color Mapping

Updated Alarm Bar color mapping function allows for Alarm Bar colors to dynamically change between different colors based on assigned channel values. There are 12 different color mapping configurations to choose from. To create a color mapped Alarm Bar, first create a new Output channel – for example ThrottlePosBar. Set Operation to Color Map Operation and then click on the ellipses (“...”).

Limit Filters	Time Filters	ECU Text	Bitmasks	Bit Text	Graphic Selector
Outputs	CAN Receive	CAN Request	Scalars	Functions	Rate Filters
Output Name	Operation	Primary Input			
EngineSpeed	EngineSpeed_scalar	EngineSpeed_raw			
ThrottlePos	ThrottlePos_scalar	ThrottlePos_raw			
ThrottlePosAlarm	Alarm	ThrottlePos			
ThrottlePosBar	Colour Map Operation	ThrottlePos			...

In the Color Map window, select the channel to reference – in this case ThrottlePos – and set the Start and End Value to scale the color mapping to and then select the desired Color Map.

Color Map

Input: ThrottlePos

Start Value: 0

End Value: 100

Colour Map: 5 Color

If Start Value is greater than End Value the map will be reversed.

OK

To add this element to a layout, unlock the layout and click on the Alarm Bar button (alarm clock icon). Place the Alarm Bar in your desired location – note that Alarm Bars can be clicked and dragged to set their shape as either a horizontal or vertical bar. Double click the Alarm Bar once placed to access the Alarm Bar Editor window.

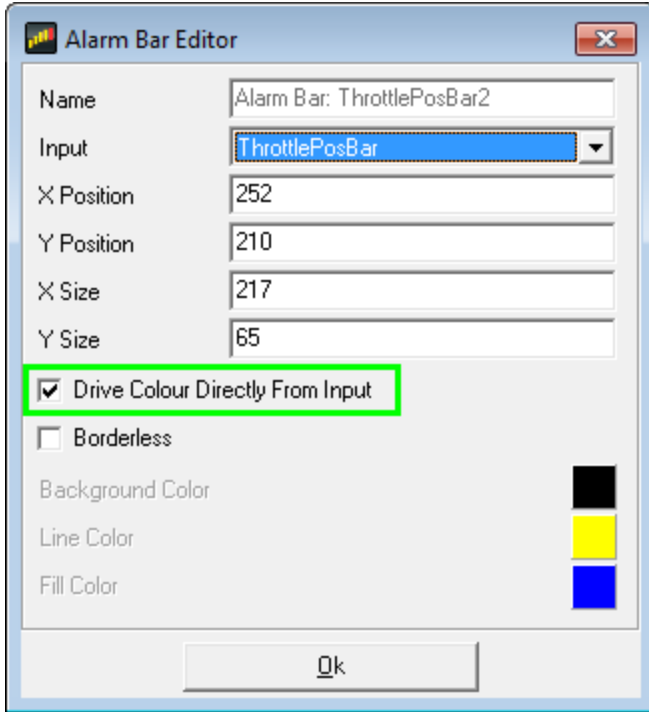

Set the input to the appropriate channel and check Drive Color Directly From Input. All other Alarm Bar functions beyond this are the same as previous versions.

For firmware version 14x17 and older:

The color value is specified as a 24 bit RGB value. The hexadecimal (and decimal) values of some common colors are shown below:

Color	Hexidecimal	Decimal
Black	0	0
Navy	80	128
Blue	0000FF	255
Green	8000	32768
Teal	8080	32896
Lime	00FF00	65280
Cyan	00FFFF	65535
Maroon	800000	8388608
Purple	800080	8388736
Olive	808000	8421376
Grey	808080	8421504
Silver	C0C0C0	12632256
Red	FF0000	16711680
Magenta	FF00FF	16711935
Yellow	FFFF00	16776960
White	FFFFFF	16777215

Typically, a function table will be used to map a given value to a specific color. To avoid interpolation between the color values, the function table should be set up such that a range of values defines one color. For example, the following function table would map brake temperatures of 0 to 250 to blue, 251 to 500 to green, 501 to 700 to yellow and 701 to 1000 to red:

Input	Output
0	255
250	255
251	32768
500	32768
501	16776960
700	16776960
701	16711680
1000	16711680

Note that it is also possible to display an alarm bar underneath a value gauge. For this to work correctly, the alarm bar must be bigger than the maximum likely size of the value gauge. When setting this up in the editor, it is easier to add the alarm bar to the page first then the value gauge; this ensures that the value gauge is visible and makes sizing the alarm bar correctly easier. If you have trouble selecting an item to edit, you can adjust its Z-Order to push it behind other objects.

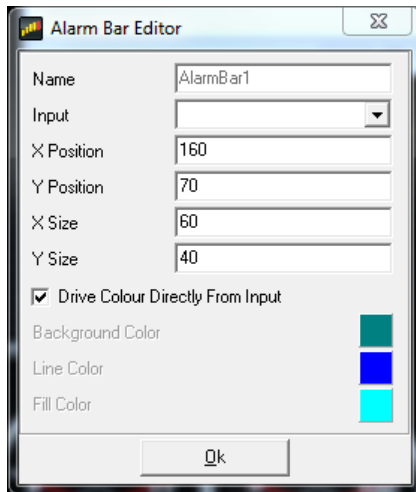

Shape Gauges

Shape gauges are static gauges (i.e. have no input) that are used to draw shapes on the screen. They have two special properties:

- **Shape** specifies the basic shape as either a Rectangle or an Ellipse.
- **Thickness** specifies the thickness of the border drawn around the shape.

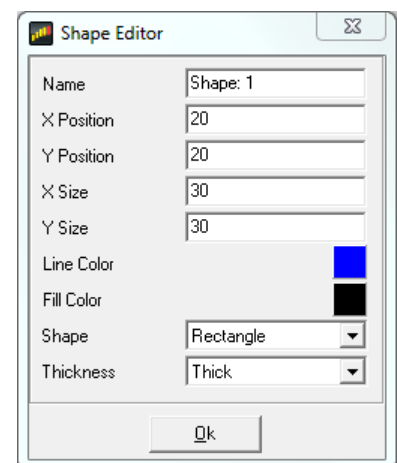

Cross Hair Gauge

The Cross Hair gauge uses two inputs to move a cross hair around a box. The cross hair gauge has the following special properties:

- **XInput**, **YInput** specify the inputs for the X and Y axes of the gauge.

- **X Minimum, Y Minimum** specify the starting values for the X and Y axes.
- **X Maximum, Y Maximum** specify the end values for the X and Y axes.
- **Cursor Size** is the size of the cross hair cursor.
- **Background graphic** can be used to specify a graphic that will be shown behind the cross hairs, This can be used to clarify the meaning of a particular position for the cross hair.

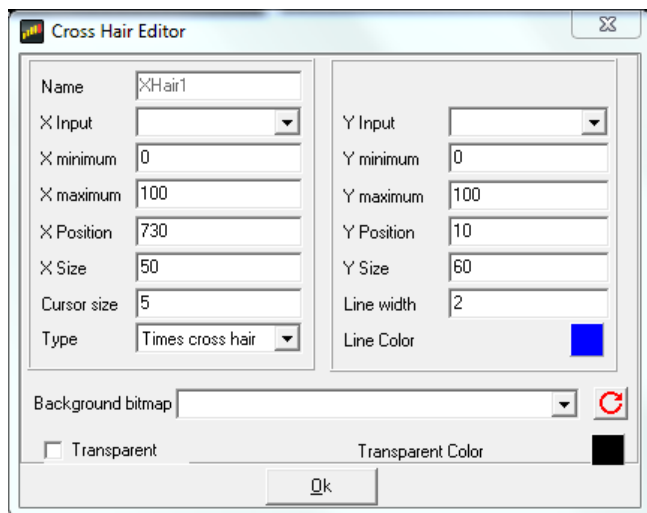

Historical Graph

The Historical Graph gauge is used to show the trend of one or more outputs in the form of a y-t graph. The Historical Graph gauge has the following special properties:

- **Time Base** - This is the width of the x axis in seconds. When a page with a historical graph gauge is first selected, the data is drawn from the left hand side of the graph ($t=0$). As the time progresses, the lines progress towards the right hand side of the graph. Once $t = \text{time base}$, the graph scrolls to the left to make more space available for drawing the lines.
- **Input Count** - The number of lines (outputs) drawn in this graph.
- The **Inputs** box allows the details of each line to be specified:
 - **Input Index** - Selects which line the following settings apply to.
 - **Input** - The output for which the line is drawn.
 - **Line color** - The color of the line.
 - **Minimum** - Specifies the lower range of the y axis of the graph for this line. If the value of the output for this line falls below this value, the line will be drawn at the minimum value.
 - **Maximum** - Specifies the upper range of the y axis of the graph for this line. If the value of the output for this line exceeds this value, the line will be drawn at the maximum value.
- **Background color** - The background color of the graph.

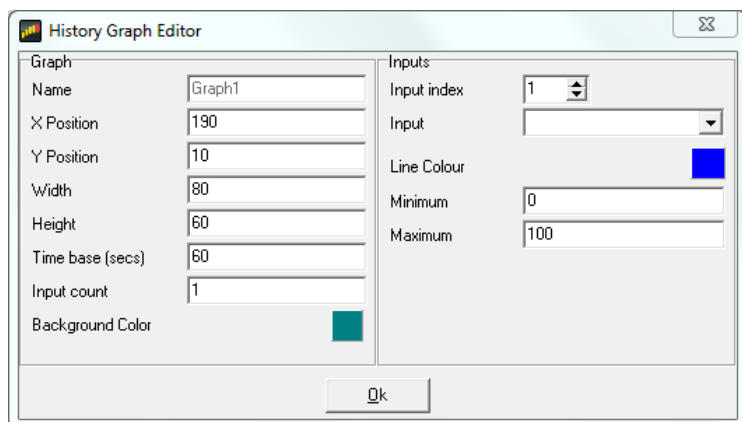

Round Tacho Graphic Gauge

The round tacho graphic gauge allows a scaled pointer or needle to be drawn over a graphic image of a gauge. This allows much more eye catching graphics to be used for round gauges than could otherwise be drawn dynamically by the display hardware.

The round tacho graphic gauge has the following special properties:

- **Background graphic** - the background gauge image.
- **X Centre, Y Centre** - The centre of the gauge from which the logical centre of the pointer will be drawn.
- **Centre Offset** - The number of pixels from the logical pointer centre at which the pointer will be drawn.
- **Length** - The length of the pointer.
- **Start Degrees** - The number of degrees from 6 o'clock (the zero degree position) that the starting value of the gauge should be drawn.
- **End Degrees** - The number of degrees from 6 o'clock (the zero degree position) that the end value of the gauge should be drawn.

The gauge default rotation is clockwise. If you want anti-clockwise operation you switch the Start Val and End Val settings.

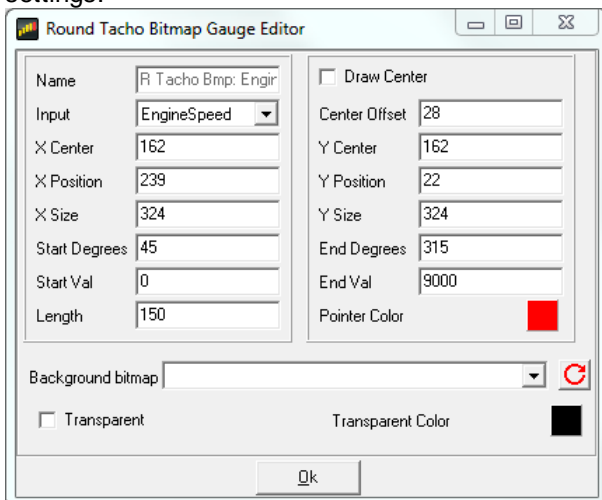

12 Month Limited Warranty

Advanced Engine Management Inc. warrants to the consumer that all AEM High Performance products will be free from defects in material and workmanship for a period of twelve (12) months from date of the original purchase. Products that fail within this 12-month warranty period will be repaired or replaced at AEM's option, when determined by AEM that the product failed due to defects in material or workmanship. This warranty is limited to the repair or replacement of the AEM part. In no event shall this warranty exceed the original purchase price of the AEM part nor shall AEM be responsible for special, incidental or consequential damages or cost incurred due to the failure of this product. Warranty claims to AEM must be transportation prepaid and accompanied with dated proof of purchase. This warranty applies only to the original purchaser of product and is non-transferable. All implied warranties shall be limited in duration to the said 12-month warranty period. Improper use or installation, accident, abuse, unauthorized repairs or alterations voids this warranty. AEM disclaims any liability for consequential damages due to breach of any written or implied warranty on all products manufactured by AEM. Warranty returns will only be accepted by AEM when accompanied by a valid Return Merchandise Authorization (RMA) number. Product must be received by AEM within 30 days of the date the RMA is issued. UEGO oxygen sensors are considered wear items and are not covered under warranty. Please note that before AEM can issue an RMA for any electronic product, it is first necessary for the installer or end user to contact the EMS tech line at 1-800-423-0046 to discuss the problem. Most issues can be resolved over the phone. Under no circumstances should a system be returned or a RMA requested before the above process transpires. AEM will not be responsible for electronic products that are installed incorrectly, installed in a non-approved application, misused, or tampered with. Any AEM electronics product can be returned for repair if it is out of the warranty period. There is a minimum charge of \$50.00 for inspection and diagnosis of AEM electronic parts. Parts used in the repair of AEM electronic components will be extra. AEM will provide an estimate of repairs and receive written or electronic authorization before repairs are made to the product.

Index

- A -

Adding gauges 105
Alarm 93
Alarm bar gauge 113
Alarm page 102

- B -

Bar gauges 109
Basic setup editing 75
Bit string 91
Bitmap 92
Bitmap gauge 113
Bitmask 91
Brightness 103

- C -

CAN 88
CAN .dbc 81
Colors 105
Copy and Paste 107
Creating setups 74
Cross hair gauge 116

- D -

Default colors 105
Default setups 74
Deleting gauges 107
Display editor 79
Display screens 104

- E -

ECU string 91
Editing gauge properties 107

- F -

Features 10

Firmware updating 86
Format 108
Function table 89

- G -

Gauge 108, 110
 adding 105
 alarm bar 113
 bar 109
 bar tacho 110
 bitmap 113
 copy and paste 107
 cross hair 116
 deleting 107
 editing properties 107
 historical graph 117
 moving 106
 progressive limit 113
 resizing 106
 round tacho 110
 round tacho bitmap 118
 selecting 106
 shape 116
 standard properties 108
 text label 111
 value 112
 value formatting 108
 variable string 111
Gauge properties
 editing 107
 standard 108
GPS 21

- H -

Historical graph gauge 117

- I -

Installation 20
Installing The AEM CAN Dash 20
Installing USB Drivers 20
Introduction 2

- L -

Lap timing 21, 97
LEDs 100
Limit filter 90
Logging 83

- M -

Monitor screen 104
Mounting 12
Moving gauges 106

- O -

Odometer 96
On change page 102
Opening setups 73
Outputs 86

- P -

Programming the display 78
Progressive limit gauge 113

- R -

Rate filter 90
Resizing gauges 106
Round tacho bitmap gauge 118

- S -

Saving setups 73
Scalar sensor 89
Screen
 adding gauges 105
 copy and paste 107
 deleting gauges 107
 editing gauge properties 107
 monitor 104
 moving gauges 106
 resizing gauges 106
 selecting gauges 106
Selecting gauges 106

Sensor
 scalar 89
Settings 99
Setup
 editor 86
Setup editor 86
Setups 73
 creating 74
 opening 73
 saving 73
 uploading 78
Shape gauge 116
Shift lights 100
Splash screen 105
Standard gauge properties 108

- T -

Tacho gauges 110
Text label gauge 111
time filter 90
Track mapping 97
Turn Blinkers 96

- U -

Updating firmware 86
Uploading setups 78
USB drivers
 Installing 20

- V -

Value formatting 108
Value gauge 112
Variable string gauge 111

- W -

Warning message 95
Wiring 17

- Z -

Z order 107
