

GFB G-Force III

Installation Instructions

Part #3005



+61 2 9534 0099

sales@gfb.com.au

www.gfb.com.au

facebook.com/GFBturbo

instagram.com/gofastbits

GFB
GO FAST BITS

TURBO MANAGEMENT SYSTEMS



PERFORMANCE WITHOUT COMPROMISE

CONTENTS

Intro	
About the G-Force III	2
Installation	
Wiring Diagram	3
Solenoid Valve Installation Diagram	4
Menu Navigation	
Menu Structure	5
Quick Start Guide	6
Boost Presets	7
Setting the Boost Pressure	
Duty Cycle	8
Gain	9
Sensitivity	10
Controller Functions	
Scramble Boost	11
Lean Cutout	12
Overboost	12
Peak Hold	13
Display Setting - Units of Pressure	13
Input 1 Setup - External Trigger	14
Input 2 Setup - Wideband AFR	14
Stoichiometric Ratio	15
Boost Gauge Calibration	15
Colour Settings	16
Additional Info	
Tips	17
Troubleshooting	17
Tech	19
Warranty	20

ABOUT THE G FORCE III

The GFB G-Force III boost controller is designed to not only bring boost on as fast and accurately as possible on a turbocharged vehicle, but also to provide you with an accurate wideband Air/Fuel Ratio gauge using an externally connected wideband module. The G-Force III incorporates an advanced and unique boost control strategy that allows the user fine control over the peak boost, rise rate, and closed-loop correction.

The G-Force III also features a revised interface, making menu navigation and setup as fast and simple as ever.

Features at a glance:

- Multifunction boost and AFR (Air/Fuel Ratio) gauge with simple menu button toggle
- Lean AFR warning can be set to cut boost pressure if engine runs too lean under load
- 6 individually programmable boost preset memories, selectable on-the-fly
- Closed-loop correction - helps prevent boost variations
- Unique scramble boost strategy - increase or decrease boost for a certain amount of time at the push of a button
- Overboost protection - shuts down the solenoid and flashes a warning if boost goes too high
- External input - can be used to activate scramble or select boost presets remotely
- Adjustable button illumination colours - match your car's existing lighting
- AFR gauge can display Lambda or AFR, and can be configured for different fuel types
- Boost/vacuum gauge display - in BAR, kPa, or PSI
- Peak hold boost pressure display

Installing the Head Unit

The G-Force III casing is a ½ DIN size, allowing to be mounted into one half of a standard stereo slot.

Alternatively, with its thin profile (18.5mm), the G-Force III can be mounted on a vertical face of the dashboard, or stood up on its edge using the supplied double-sided mounting tape.

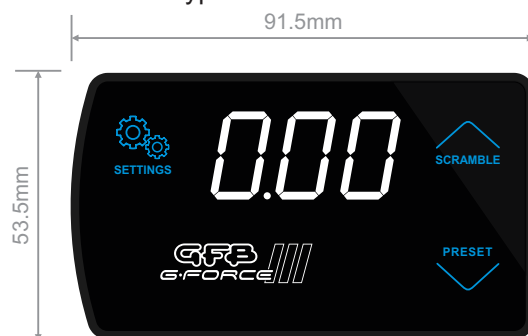

GFB
GO FAST BITS

Engine Bay

To intake manifold - use small Tee to tap into an existing vacuum hose if necessary

1/8" I.D. vacuum hose

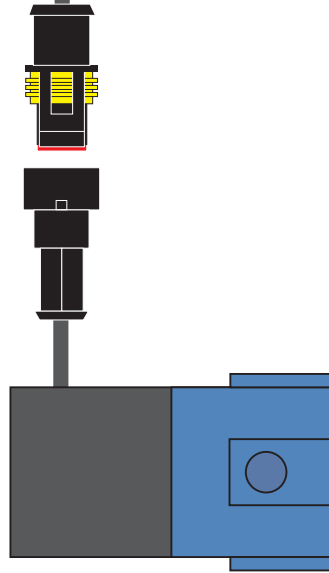

3-Port Boost Control Solenoid

(4-port solenoid available separately. GFB Part # 3845)

Vehicle Interior

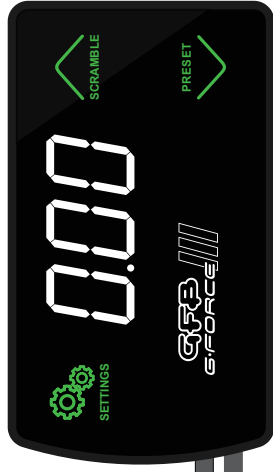

Vacuum hose joiner

Loom

Yellow wire - Input 2
(Connect to Wideband module for AFR display. See notes below for details)

Blue wire - Input 1
(see notes below, and pages 14 & 17 for details)

Red wire - +12V switched power source. It is recommended to connect via a 5A fuse (not supplied)

Black wire - Vehicle ground (chassis)

Optional Remote Trigger Circuit

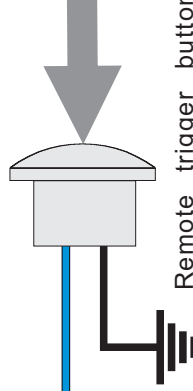

Remote trigger button (not supplied). Use any switch, button or sensor that grounds the blue wire when activated

Input 1 (blue wire) can be used as a remote trigger simply by connecting it to any kind of switch, button, or programmable ECU output that grounds the blue wire to the vehicle earth when activated. For ideas on different ways to use this feature, see page 17. Once connected, the function of Input 1 must be configured within the "In.1" sub-menu (see page 14).

Input 2 (yellow wire) may be connected to an external Wideband O2 control module/sensor (not supplied). Connect the blue wire directly to your wideband controller's auxiliary 0-5V analogue output, then configure using the "In.2" sub-menu (see page 14).

If either the blue or yellow wire are not used, simply cut or bundle them and make sure they are insulated.

WARNING! DO NOT connect the blue or yellow wire to a 12V source as this could damage the unit.

SOLENOID VALVE INSTALLATION



PLEASE READ before installing the G-Force III on a vehicle that has an existing factory boost control solenoid.

The G-Force III is designed to work as a stand-alone boost controller, therefore any existing factory-fitted boost control devices must be removed or disabled.

However, disconnecting a factory-fitted solenoid valve from the car's wiring loom may cause an ECU error code and/or a Check Engine warning light. To prevent this, leave the factory solenoid in place with the electrical wires connected, but remove the vacuum/boost hoses.

You can prevent dirt from getting into the factory solenoid whilst it is not in use by simply connecting its inlet and outlet together with a short loop of hose.

The G-Force III solenoid should be mounted in a position away from significant heat sources (such as the exhaust manifold and turbine), and where it is protected from rain or splashed water. The unused outlet of the solenoid valve should be positioned in a way to prevent ingress of dust, dirt and water.

DO NOT plug the unused solenoid port, as this will prevent the controller from being able to adjust boost pressure.

Internal Wastegate

Screw the two supplied hose tails into ports 2 and 3 of the solenoid valve, and connect the ports to the correct locations as shown using the supplied 3/16" hose.

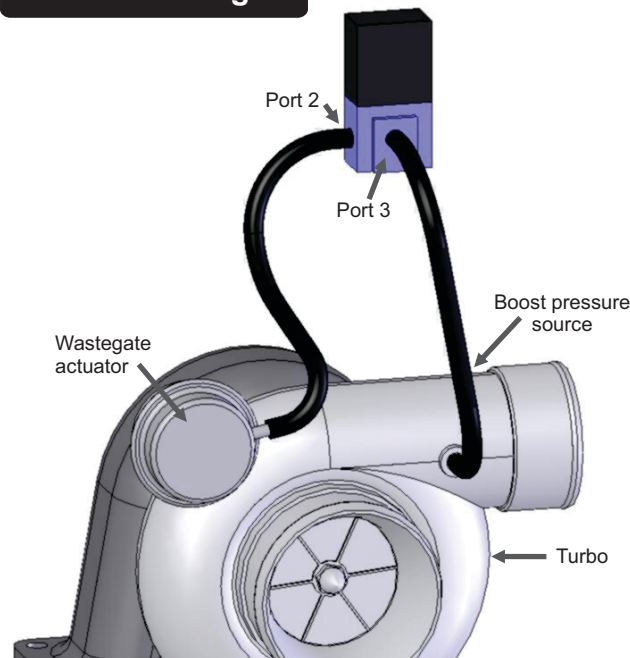

External Wastegate

Screw the two supplied hose tails into ports 1 and 2 of the solenoid valve, and connect the ports to the correct locations as shown using the supplied 3/16" hose.

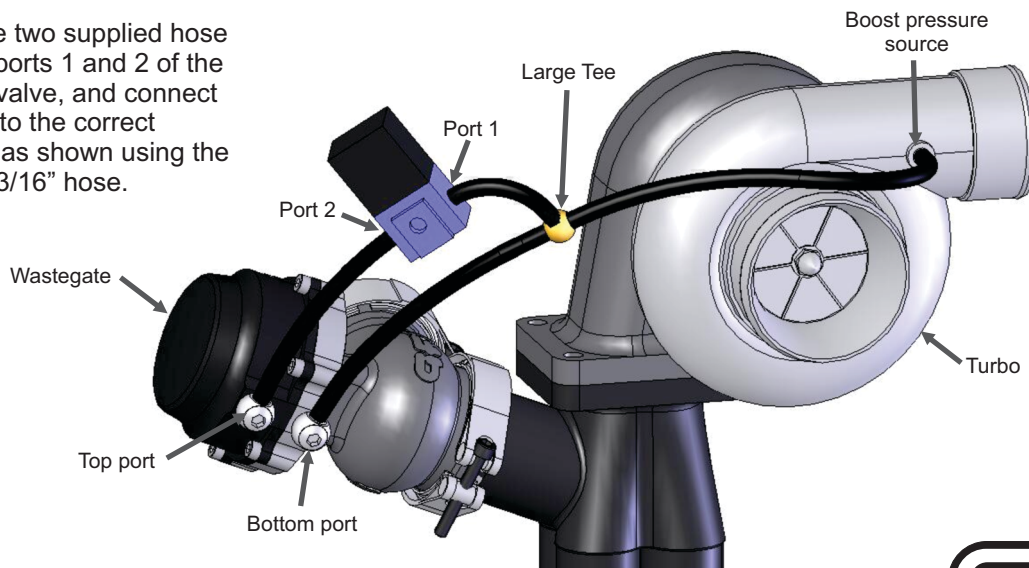

GFB

GO FAST BITS

MENU STRUCTURE

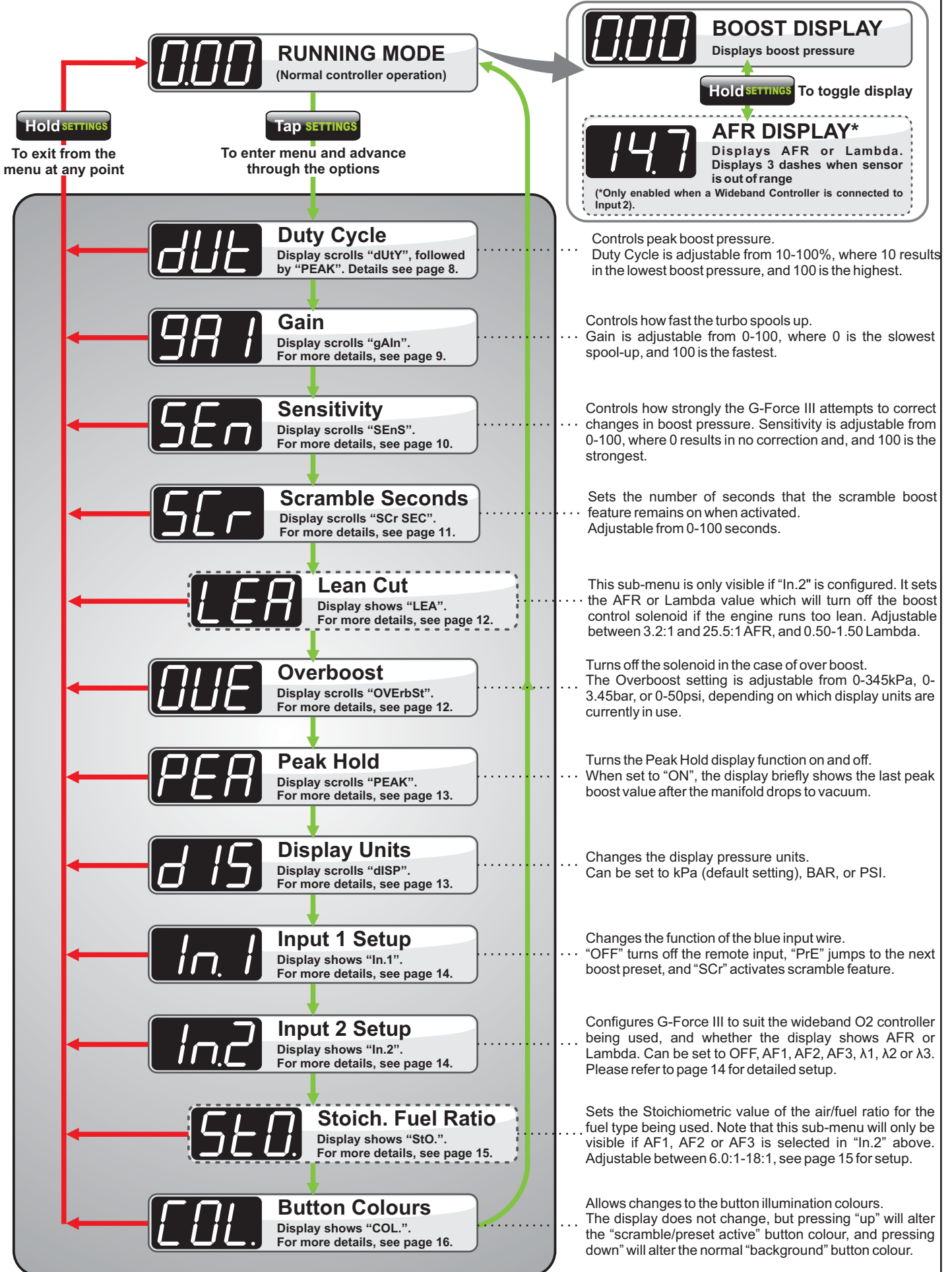

GO FAST BITS

QUICK START GUIDE

It is strongly recommended that you read the entire instruction manual before setting up the G-Force III, but if you just can't wait, here is a quick start guide. This is the minimum amount of information you will need to get it up and running, and controlling boost pressure.

MENU NAVIGATION

Tap the "SETTINGS" button to enter and advance through the menu options. Press and hold "SETTINGS" to save changes and exit the menu at any point. See page 5 for menu structure.

BASIC SETUP - these are the minimum recommended settings before using your G-Force III

- » After installation (page 3 & 4), turn the ignition on to power up the G-Force III, but DO NOT start the engine
- » Check that the display shows exactly zero. If not, see page 15 for calibration
- » Enter menu and advance to "dIS" to set boost gauge display units. You can select between kPa (default), psi or BAR by pressing up or down buttons (see page 13)
- » Navigate menu to "OUr" to set the overboost value slightly higher than your intended peak boost (see page 12) - this is important for the safety of your engine during setup to prevent accidental overboosting

BASIC BOOST PRESSURE SETUP

- » Navigate menu to "DUt" and ensure duty cycle is set to 10%. IMPORTANT - DO NOT EXIT OR ADVANCE THROUGH MENU until you have finished the steps below
- » Perform a full throttle boost run (3rd or 4th gear preferable) to record your baseline boost pressure. Once you lift off the throttle, the display will alternately show you the peak boost you achieved, and the current duty cycle
- » If the peak boost is considerably lower than your intended target, increase duty cycle to 25% and perform another boost run. If you are already close to your desired target, make a smaller adjustment to avoid overboosting. Once you make a change to the duty cycle, the peak boost value is cleared, requiring you to perform another boost run to record the new peak boost

(Please note that duty cycle values between 10-20% generally have little effect on peak boost, but adjustments above 20% will start to make larger changes in boost pressure)

- » Perform another boost run, check the peak boost, and continue making duty cycle adjustments until you achieve your desired target boost.
- » Exit menu ONLY when you are satisfied with the boost pressure achieved - the display MUST show a peak boost, because if you accidentally clear the peak boost by adjusting the duty cycle without performing a boost run, additional functions on the G-Force III will not work.

For more detailed boost setup information, see pages 8-10.

BOOST PRESETS

The G-Force III has 6 boost presets (P1-6), each of which can be individually programmed and accessed quickly on-the-fly using either the "PRESET" button on the G-Force III, or remotely by using the "Input 1" wire connected to a push button switch.

There is an additional preset called "SCr", which is the preset that is activated when the scramble feature is used. See page 11 for more info on the scramble boost feature. "SCr" can be set up and used just like any other preset, so effectively there are actually 7 presets in total.

Whilst 7 presets may be more than most people will use, there are a number of ways they can be utilized to further fine-tune your boost to suit whatever it is you plan to do with your car, whether it be for street, drag, circuit, or drift. See the suggestions listed on page 17 for ideas on different ways the boost presets (and other features) can be used.

Each boost preset consists of 3 adjustments that can be used to tailor the boost characteristics:

- **Duty cycle** - controls peak boost pressure
- **Gain** - controls how fast the boost rises
- **Sensitivity** - controls the strength of the closed-loop correction – i.e. how strongly the controller attempts to correct boost pressure changes and taper

Note that it is not necessary to set or use Gain and Sensitivity to set the boost pressure - for simplicity, boost can be controlled only by Duty Cycle if so desired. Usually, a well-matched turbo/wastegate/engine will respond very well with only Duty Cycle adjustments, however these features are helpful when your goal is to extract the most out of your turbo system.

For best results, these three adjustments should be made in the order listed above, as each correction builds on the previous one.

To select boost presets:

From **Running Mode**, tap the PRESET button (or the remote input 1 if installed and configured, see page 3 and 14 for details) to sequentially scroll through the boost presets from 1-SCr, as shown below:

Running Mode

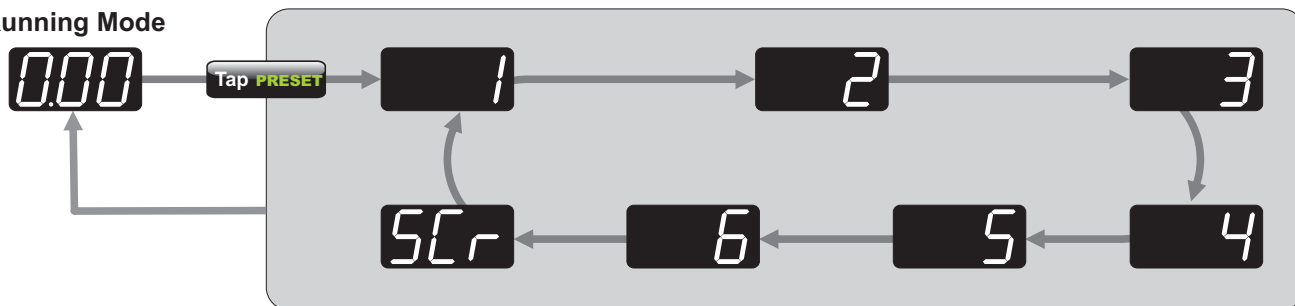

Whenever the PRESET button or remote trigger is used to change the preset, the PRESET button momentarily changes colour as an additional visual indication that a preset change has occurred. The colour that the button changes to can be set in the COL (Colour) menu (see page 16).

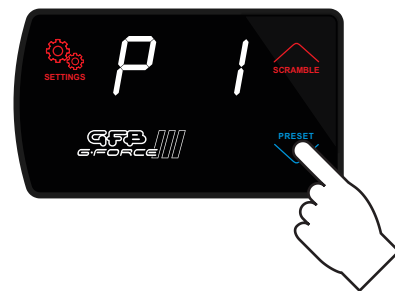

Whenever the manifold is in vacuum and a new boost preset is selected, the display will show the boost preset number, followed by the target boost pressure associated with that preset before returning to Running Mode after a few seconds:



If the manifold is in boost, the display stays as a boost gauge, but the PRESET button still changes colour to indicate a preset change.



BEFORE adjusting duty cycle, it is **HIGHLY** recommended that you first set up the **OVERBOOST** feature (see page 12 for more information).

OVERBOOST is a “global” setting that will turn off the solenoid if boost pressure exceeds the overboost setting (regardless of the boost preset currently being used), which is intended to prevent damage to your engine if the controller is adjusted incorrectly or accidentally.

The factory default setting is 100kPa (1 bar, 14.5psi).

The duty cycle setting controls the peak boost pressure, and is adjustable from 10-100%, where 10 represents the *lowest* possible boost pressure your turbo system is capable of running (commonly referred to as “base” or “wastegate” pressure), and 100 represents the *highest*.

See page 19 for a detailed description of what duty cycle is and how it works.

The duty cycle must be increased carefully and incrementally until you arrive at a setting that results in the target boost pressure that you want to achieve.

1. Select the boost preset that you want to adjust (see page 7).
2. Tap “SETTINGS” once to navigate to “Duty Cycle” - the screen will scroll “DUtY”, followed by the current duty cycle setting, then “PEAK”, followed by the current peak boost recorded for that duty cycle setting. **DO NOT EXIT the menu until the boost setup process is complete.**
3. Tap the up/down buttons to adjust the duty cycle setting - it is safest to start at 10 so you can see your car’s minimum boost pressure, and make adjustments from there. **NOTE:** whenever you make adjustments to the duty cycle, the “PEAK” boost value will clear to 0.
4. Drive the car to record the peak boost – you will need to ensure that you perform a full throttle run, sweeping through the engine’s peak torque RPM in the highest gear possible/practical to ensure the controller records the true peak boost - you can do this as many times as you like until you’re sure you’ve recorded the true peak boost.
5. After lifting off the throttle, the display will alternately show the duty cycle and the peak boost. If the peak boost is lower than your desired target, increase the duty cycle, then drive the car again (using the same method as above to ensure consistency) to record the new peak boost.
6. Continue to make adjustments until the peak function displays your desired target boost pressure, and do NOT make any further duty cycle adjustments or the peak value will reset to 0.
7. Tap “SETTINGS” to move on to GAIN, or hold “SETTINGS” to exit. In either case, the duty cycle setting and peak boost will be saved to the boost preset that you are currently in. The G-Force III will use these stored values for the GAIN and SENSITIVITY features. If you do not record a peak boost, the controller will still work, but GAIN and SENSITIVITY will not be able to make any closed-loop corrections.
8. Repeat this procedure for any other boost presets you may wish to set up.

NOTES:

- At 10% duty cycle, the solenoid valve is effectively completely switched off, and above 95% it is effectively fully switched on. It is not possible to run less boost than what you can achieve with 10% duty unless you change the wastegate. To run higher boost pressures than what you can achieve with 95% duty, you must change the turbo or wastegate, or use a 4-port solenoid valve (available from GFB, part # 3845).
- It is not unusual for duty cycle values up to 20% to make little change to the boost pressure, because the solenoid valve response is non-linear. That is why the minimum duty cycle in all boost presets is 10%. You may find it necessary to adjust duty as high as 25% before you start to notice an increase in boost pressure - this is completely normal.
- The higher the required duty cycle to achieve your target boost, the harder boost is to control - it is more likely that boost will taper at high RPM and vary more according to atmospheric conditions with duty cycles in the upper end of the range.
- For the reason above, it may be difficult to run high and low boost pressures that are vastly different from each other, for example a low boost of 10psi and a high boost of 30psi simply may not be possible with the turbo and wastegate.



GO FAST BITS

The Gain setting can help spool up the turbo faster by withholding pressure from the wastegate until boost is closer to the target boost.

NOTE: the Gain setting requires a peak “target” boost to be set up in the Duty Cycle menu (page 8). If you adjust Duty Cycle without performing a boost run, the target boost will be 0 and the Gain function will not be operational.

Gain is adjustable from 0-100, where 0 gives a factory-like spool up, which is basically the “natural” rise rate of the turbo system. A setting of 100 will attempt to make boost rise **as fast as the turbo system is capable of** by delaying the opening of the wastegate until the target boost is met.

Of course it may then be tempting to assume that the obvious setting would simply be 100 for fastest possible spool-up, but in practice this will likely result in an overshoot (boost spike), because the wastegate needs time to move and curb the turbo’s enthusiasm!

Every turbo system is different, and some will handle more gain without noticeable spiking, whilst others may require a lower setting. The Gain setting is optimum when boost pressure rises as fast as possible WITHOUT spiking.

1. Make sure duty cycle has first been set and a peak “target” boost recorded, as per page 8.
2. Select the boost preset that you want to adjust (see page 7), then navigate to the “Gain” menu (tap “SETTINGS” twice from Running Mode) – the screen will scroll “gAln”, followed by the current gain setting (default is 0).
3. With gain set to 0, drive the car in such a way that the boost pressure rises as fast as possible – this is usually done by accelerating gently to the RPM at which your engine makes peak power, then flooring the throttle.
4. Now increase the gain setting by 20 using the “UP” button, then drive the car again (using the same method as above to ensure consistency).
5. Note how the boost spool-up rate changes, and continue to adjust the gain setting to achieve the desired boost response. If you notice that boost starts to spike, reduce the Gain setting until boost pressure hits the target consistently without overshooting.
6. When done, tap “SETTINGS” to move on to Sensitivity, or hold “SETTINGS” to exit. In either case, the Gain setting will be saved to the boost preset that you are currently in.
7. Repeat this procedure for any other boost presets you may wish to set up.

NOTE: the Gain function is automatically turned off when making boost pressure adjustments (in Duty Cycle menu) so that it does not interfere and cause incorrect peak boost readings from spikes, however the Gain setting will be reactivated when you return to Running Mode.

You may find it necessary to re-adjust the Gain setting after changing the boost pressure.

The Sensitivity setting controls a closed-loop correction factor that attempts to correct any difference between the actual boost and the target boost pressure. This is useful on a turbo that tends to drop boost pressure as RPM rises (boost taper), and can also help pull boost pressure up to the target when it is rising very slowly (such as in a very high gear at low RPM).

NOTE: the Sensitivity setting requires a peak “target” boost to be set up in the Duty Cycle menu (page 8). If you adjust duty cycle without performing a boost run, the target boost will be 0 and Sensitivity will not perform closed-loop corrections.

Boost taper is common on small factory turbos, because they are typically sized for mid-range response rather than top end power, and as such they tend to “run out of puff” at high RPM.

The Sensitivity feature can help reduce boost taper. It is adjustable between 0-100, where 0 results in no closed-loop correction at all, and 100 is the strongest correction possible.

If the setting is too high, the boost pressure might start to become unstable, where it constantly “hunts” up and down, so this is another setting that should be tested experimentally to find what works best for your turbo.

If you notice that boost pressure falls away at high RPM and you want to try to correct this behaviour, follow the steps below:

1. Make sure Duty Cycle has first been adjusted and peak boost set, as per page 8. It is not necessary to set gain for sensitivity to work, but if you do plan to use gain you should set it before adjusting sensitivity.
2. Select the boost preset that you want to adjust (see page 7), then navigate to the “Sensitivity” menu (tap “SETTINGS” three times from Running Mode) – the screen will scroll “SEnS”, followed by the current Sensitivity setting (default is 0).
3. Drive the car in such a way that the boost pressure falls off at high RPM, and take note of the highest pressure drop and the RPM, e.g. boost falls from 18psi at 5000RPM to 15psi by 7000RPM.
4. Now increase the Sensitivity setting using the up/down buttons, then drive the car again (using the same method as above to ensure consistency).
5. Note how the boost taper rate changes, and continue to adjust the Sensitivity setting to achieve the desired result. If you notice that boost starts to become unstable (i.e. oscillates up and down rapidly), reduce the sensitivity setting until stable boost pressure is achieved. It may not always be possible to completely eliminate boost taper depending on how severe it is, but this setting will at least ensure that everything the turbo system is capable of is being delivered.
6. When done, tap “SETTINGS” to move on to the next menu item, or hold “SETTINGS” to exit. In either case, the Sensitivity setting will be saved to the boost preset that you are currently in.
7. Repeat this procedure for any other boost memories you may wish to set up.

NOTE: the Sensitivity function is automatically turned off when making boost pressure adjustments (in the Duty Cycle menu) so it does not interfere, however it will be reactivated when you return to Running Mode.

There are limits to what the G-Force III can do with the turbo and wastegate – if the duty cycle setting is already quite high, there is not much adjustment left for the controller to make if boost drops off – once the closed-loop corrections reach 100% duty cycle, there’s nothing more the controller can do as this is the limit of the turbo system. Also

Because of this, it may not always be possible to completely eliminate boost taper, although it should be able to be reduced at the very least. Keep in mind that attempting to force a small factory turbo to make high boost at high RPM can potentially increase the exhaust backpressure, charge temperature, and turbo shaft speed without making any significant improvement in power. The only solution when you reach this point is to upgrade to a larger turbo, different wastegate spring, or both.

SCRAMBLE BOOST

Scramble boost is a feature that allows you to increase or decrease boost pressure for a certain amount of time by clicking a remote-mounted button or switch (see page 3 for details on how to wire up a remote button/switch), or the “SCRAMBLE” button on the G-Force’s screen. This feature may be useful in the following example situations:

- In a drag-race, the Scramble feature could be set up to allow the car to launch on a low boost setting to maintain traction off the line, then activate a high boost setting further down the track either manually by pressing a steering wheel-mounted button or automatically using the Scramble timer.
- In circuit racing, Scramble could be used as a “push-to-pass” system, where a little extra boost pressure could help during overtaking, but is not desired throughout the entire race for the longevity of the engine.
- In a high-powered car it might be desirable to run lower boost for better drivability, civilised behaviour on the street, or better fuel economy, then use Scramble when full power is needed.
- Use Scramble to LOWER boost pressure to safe-guard the engine, such as when a water spray or water/meth injection tank is empty, or the ambient temperature is very high - this could even be set up to be automatic if connected to a sensor or warning output.

The G-Force III uses a unique approach to Scramble where it jumps to a dedicated Scramble boost preset when activated, instead of simply adding extra boost. This method offers much more flexibility in how it can be used because you can tailor the duty cycle, gain, and closed-loop correction specifically to suit the purpose that you intend to use this feature for. In this way, you can raise OR lower boost pressure, as well as change the spool-up rate and closed-loop correction, which cannot be done with traditional scramble methods.

Setting up Scramble:

When activated, the Scramble feature jumps from whatever boost preset you are currently in to the boost preset called “SCr”. Therefore, you need to set the desired Duty Cycle, Gain, and Sensitivity parameters that you want when Scramble is activated. To do this, you simply set up the boost preset called “SCr” just as you would for any of the other 6 boost presets (see pages 7-10).

In the Scramble setting, you adjust the number of seconds that scramble remains active after the button or trigger is released.

Navigate to the Scramble setting (display shows “SCr”, which then scrolls “SCr. SEC”) using the “SETTINGS” button, then use the up/down buttons to adjust the scramble time. This setting is adjustable from 0-99 seconds (default is 0). When 0 is selected, the Scramble feature is inactive.

Using the Scramble feature:

Once the SCr boost preset and Scramble Seconds are set up, you can activate the Scramble feature at any time by tapping the “SCRAMBLE” button, or grounding the remote input (see below). The “SCRAMBLE” button will change colour (you can alter the colour that it changes to in the **Colour** menu, see page 16) and Scramble will activate immediately. The scramble timer however will only start when you *release* the button. The button will remain lit in a different colour to indicate that Scramble is active until the timer finishes.



If you want to activate Scramble using a remote-mounted button, switch, ECU output etc, you need to first connect the blue “Input 1” wire to the button/switch/ECU output you want to use (see page 3 for wiring diagram), then set “Input 1” to “SCr” (see page 14, “Input Setup”). Once you have done this, the remote input will replicate the function of the “SCRAMBLE” button, which will also change colour in the same way to indicate when the Scramble function is active.

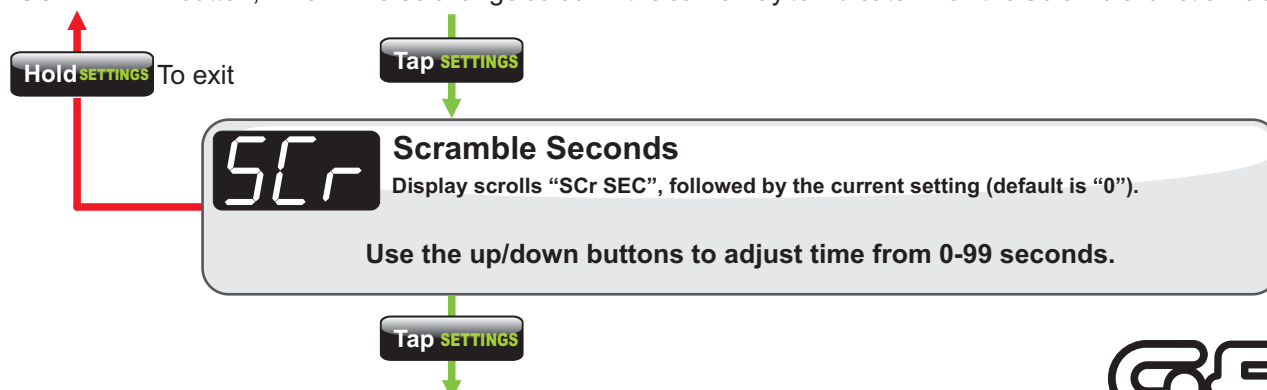

LEAN CUTOUT

Lean Cutout (when enabled through Input 2 setup, page 14) is a safety feature which will instantaneously switch off the boost control solenoid to lower boost pressure to protect the engine if it runs leaner than this user-adjustable AFR value AND the boost pressure is greater than 80% of your peak “target” boost. For this feature to work correctly, you need to ensure you have recorded a peak “target” boost in the Duty Cycle menu (see page 8).

Lean Cutout is a global setting, and once set up will function in all presets regardless of whether the display is showing boost or air/fuel ratio.

This setting appears in the same units as what you set the AFR gauge to (see page 14, “In.2” setting). If you have chosen AFR, the Lean Cutout value can be adjusted between 3.2:1 and 25.5:1. If you are using Lambda, the Lean Cutout value is adjustable between 0.50 and 1.50.

Note the default setting is 25.5 AFR/1.5 Lambda, which effectively turns this function off. This Lean Cutout value should be lowered to just above the maximum air/fuel ratio you expect to see when the car is at full boost.

If you hit the Lean Cutout when driving, the display will show “AFr”, and the buttons will flash red.

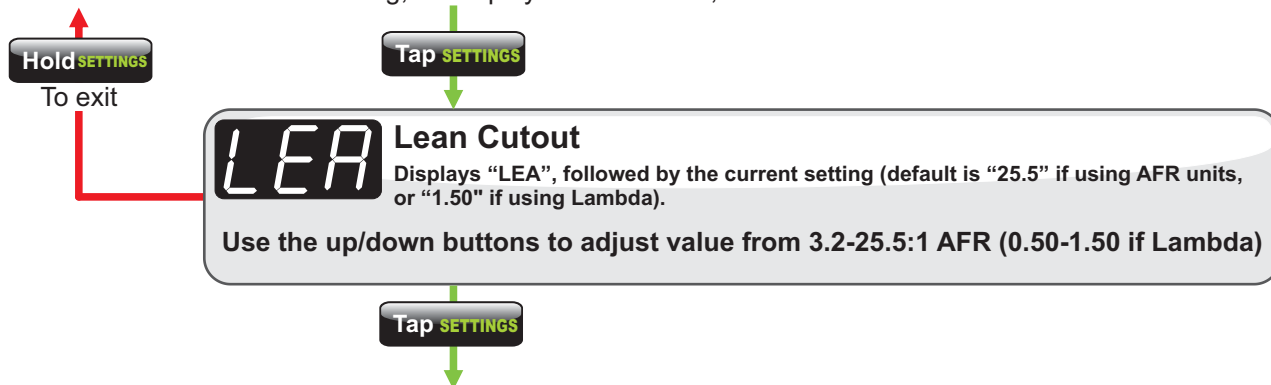

OVERBOOST

Overboost is a safety feature that will turn off the solenoid if the boost pressure exceeds the limit set in this menu option. This will help prevent damage to the engine if an accidental or incorrect adjustment is made to the controller, which is particularly helpful during boost setup.

This is a “global” controller setting, and is shown in the same pressure units as the display. It functions the same for every boost memory regardless of whether the gauge is showing boost or air/fuel ratio.

The factory default value for Overboost is 100kPa (1bar, or 14.5psi). Overboost is adjustable between 0 - 345 kPa (0 - 3.45 bar, 0 - 50 psi). If you do not want to use this feature, simply set it to the maximum boost pressure.

It is strongly advised that Overboost is set BEFORE making boost pressure adjustments. You should choose a maximum limit slightly above your intended peak boost pressure so it doesn't trigger prematurely with small boost fluctuations. Typically, a good setting for Overboost is 10% higher than your peak target boost.

NOTE: The Overboost feature CANNOT protect against a boost overshoot caused by a stuck wastegate or popped wastegate/solenoid hose connection, since these kinds of failures are outside of the G-Force III's control.

If you hit the Overboost function when driving, the display will show “Cut”, and the buttons will flash red.

- From **Running Mode**, use the “SETTINGS” button to navigate to the **Overboost** setting (display scrolls “OVERbOOST”)
- Use the “UP/DOWN” buttons to adjust the value
- Tap “SETTINGS” to save and move to the next menu item, or hold “SETTINGS” to save and exit to **Running Mode**

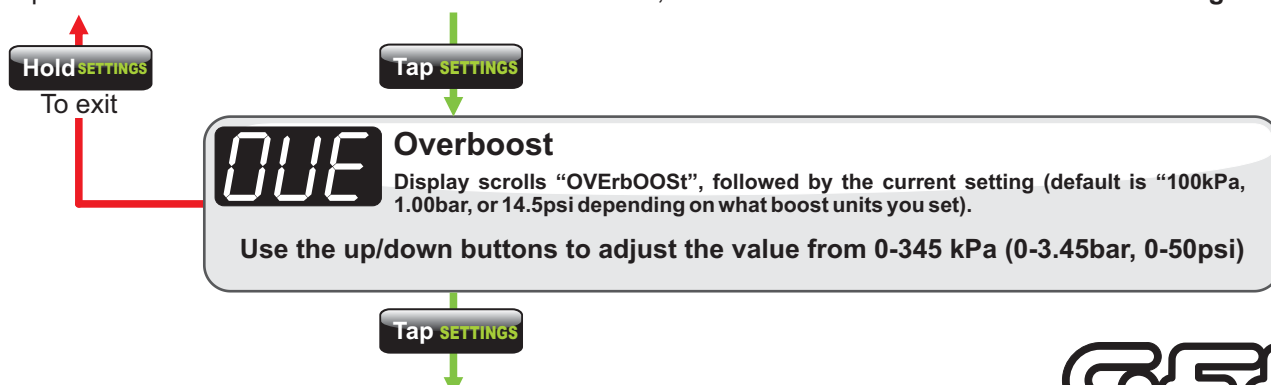

PEAK HOLD

The **Peak Hold** function (when activated in the menu) will momentarily display the highest boost pressure recorded during a boost run, and the display is set to show boost pressure (not during AFR display).

Whenever the manifold starts to see positive boost pressure, **Peak Hold** will begin recording and will displayed the highest achieved value for 3 seconds as soon as the manifold drops back into vacuum. Each time the manifold goes into boost, **Peak Hold** is cleared and it starts recording again.

Peak Hold can be set to "ON" or "OFF".

- From **Running Mode**, use the "SETTINGS" button to navigate to the **Peak Hold** setting (display scrolls "PEAK")
- Use the "UP/DOWN" buttons to toggle it on or off
- Tap "SETTINGS" to save and move to the next menu item, or hold "SETTINGS" to save and exit to **Running Mode**

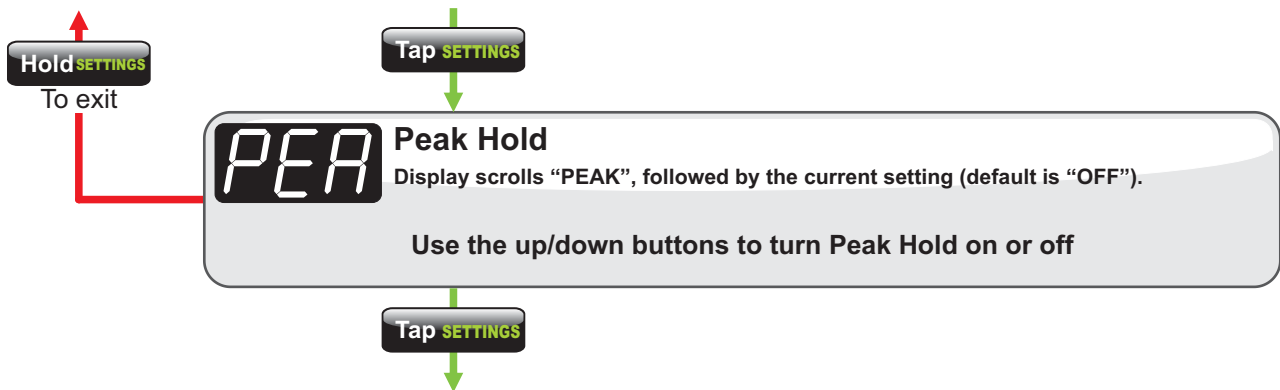

DISPLAY SETTING - UNITS OF PRESSURE

Display allows you to configure the boost gauge display to read boost pressure in kPa (default), BAR or PSI.

Note that when PSI is selected, vacuum is displayed in inHg (inches mercury), which is the same as found on most psi unit boost gauges.

- From **Running Mode**, use the "SETTINGS" button to navigate to the **Display** setting (display scrolls "dISP")
- Use the "UP/DOWN" buttons to select from "KPA" (default), "BAR" or "PSI"
- Tap "SETTINGS" to save and move to the next menu item, or hold "SETTINGS" to save and exit to **Running Mode**

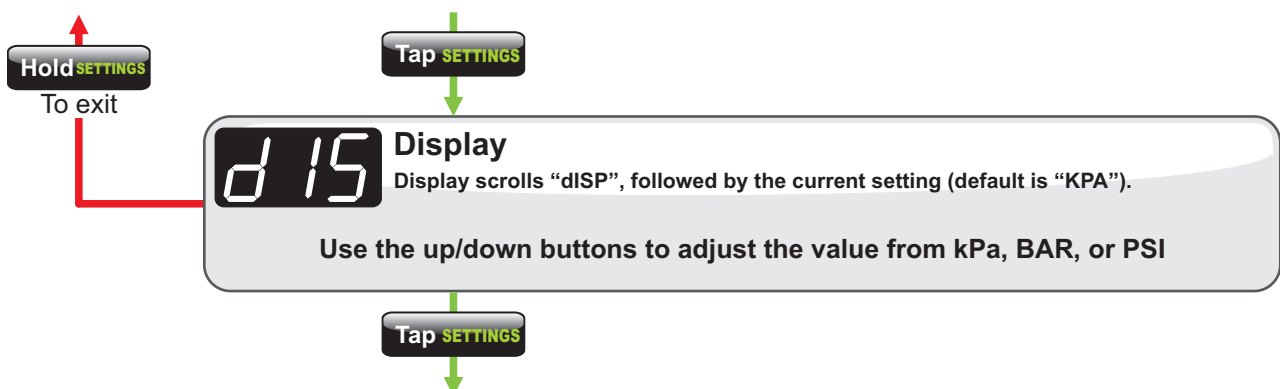

INPUT 1 SETUP - EXTERNAL TRIGGER

Input 1 Setup allows you to configure the purpose of the external input 1 (blue wire). For information on how to connect external input 1 to a button or switch, see the wiring diagram on page 3.

There are three modes for this input:

- **OFF** - no action
 - **SCr** - the scramble feature is activated when the external input is triggered
 - **PrE** - scrolls sequentially through the boost pressure memories when triggered (in the same way as pressing the “down” button in running mode)
- From **Running Mode**, use the “SETTINGS” button to navigate to the **Input 1** setting (displays “In.1”)
 - Use the “UP/DOWN” buttons to select from “OFF” (default), SCr, or PrE
 - Tap “SETTINGS” to save and move to the next menu item, or hold “SETTINGS” to save and exit to **Running Mode**

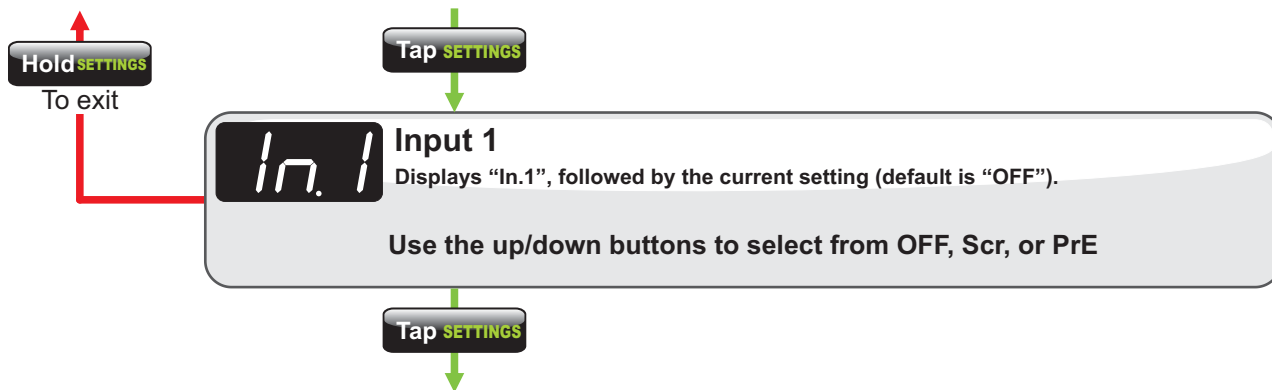

INPUT 2 SETUP - WIDEBAND AFR

Input 2 Setup configures the external input 2 (yellow wire, see page 3) to a third party wideband AFR module, and also allows you to choose whether the gauge shows AFR units or Lambda. Please note that different brands of wideband modules output different analogue voltage ranges - some are configurable, others are fixed. The G-Force III has 3 different presets to suit the more popular wideband modules on the market.

Select your preferred units and the corresponding wideband module you are using from the following list:

- **OFF** - no action, disables the external wideband AFR module (menu item “Lean Cutout” will not be visible).
 - **AF1** - Innovate LC1/LC2 wideband module, displaying Air/Fuel Ratio.
 - **AF2** - AEM wideband module, displaying Air/Fuel Ratio.
 - **AF3** - PLX SM-AFR, APSX, 14point7, or other** wideband module, displaying Air/Fuel Ratio.
 - **λ1** (display shows lambda character as λ) - Innovate LC1/LC2 wideband module, displaying Lambda.
 - **λ2** - AEM wideband module, displaying Lambda.
 - **λ3** - PLX SM-AFR, APSX, 14point7, or other** wideband module, displaying Lambda.
- From **Running Mode**, use the “SETTINGS” button to navigate to the **Input 2** setting (displays “In.2”)
 - Use the “UP/DOWN” buttons to select from “OFF” (default), AFR1, AFR2, AFR3, λ1, λ2 or λ3
 - Tap “SETTINGS” to save and move to the next menu item, or hold “SETTINGS” to save and exit to **Running Mode**

NOTE: If you are running a Flex Fuel Sensor, we recommend using Lambda and not AFR.

** When running an unlisted wideband module with a configurable analogue output, use AFR3 or λ3 and calibrate the output voltage range to the following: 0V=0.68 lambda/9.86 AFR, and 5V=1.36 lambda/20.0 AFR.

The G-Force III display will show 3 dashes (---) when the sensor is warming up or if the AFR is off the scale (i.e. during deceleration when the injectors cut).

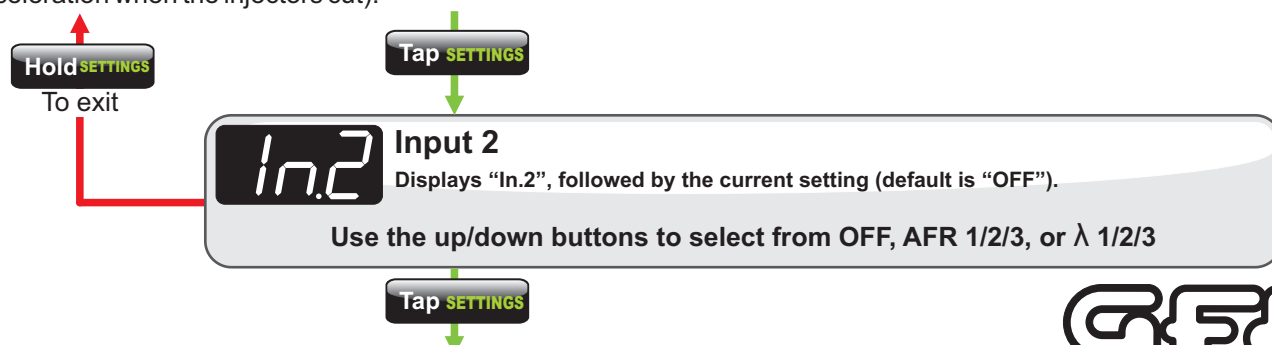

GFB

GO FAST BITS

STOICHIOMETRIC RATIO

Stoichiometric Ratio setting requires you to configure the G-Force III to the specific fuel you are using. By default, we have configured this setting to 14.7:1 for regular gasoline. If you do not make the correct changes to the stoichiometric ratio for the fuel type you are running, the display gauge will be inaccurate.

Here is a basic list of stoichiometric ratios of commonly used fuels:

Unleaded Gasoline:	14.7:1
Diesel:	14.6:1
Compressed Natural Gas:	17.2:1
Liquid Propane (LPG):	15.6:1
85% Ethanol (E85):	9.8:1
100% Ethanol (ETOH):	9.0:1
Methanol (MEOH):	6.5:1

NOTE: The Stoichiometric Ratio setting will only be shown in the menu if you have selected Af1, Af2, or Af3 in the Input 2 setup of the previous step.

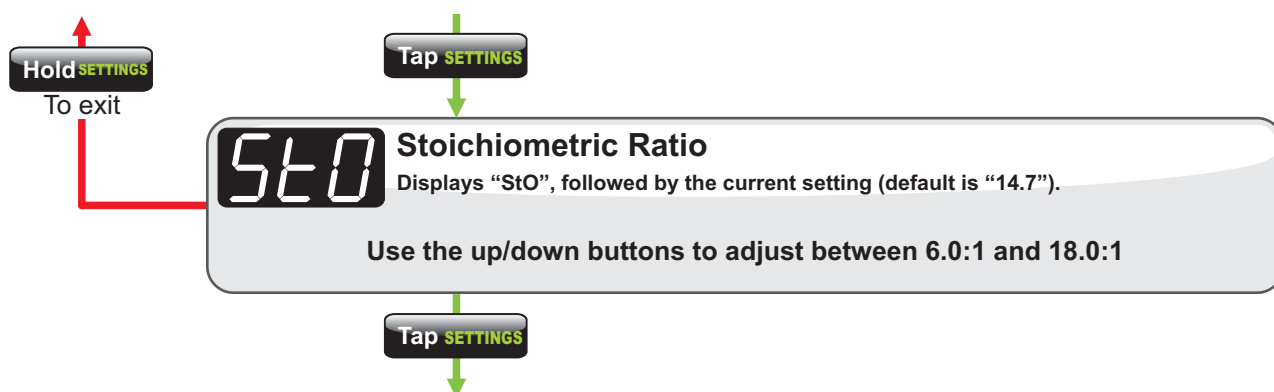

BOOST GAUGE CALIBRATION

Boost Gauge Calibration is a feature that is not accessed via the menu. It is only to be used if the boost gauge display does not read zero with the engine off. If your gauge is not reading zero with the engine off, you will most likely not be able to access the menu and the buttons may appear "dead" and non functional

- To re-zero the boost gauge:
- Turn the ignition off
 - Turn the ignition on, but **DO NOT START THE ENGINE**
 - When the display starts to show "gFb", press and hold the down button
 - When the display shows "CAL", you can release the down button
 - The display will now show "OH." (i.e. "OK") to indicate a successful calibration
 - The G-Force III is now functional and the gauge will read zero

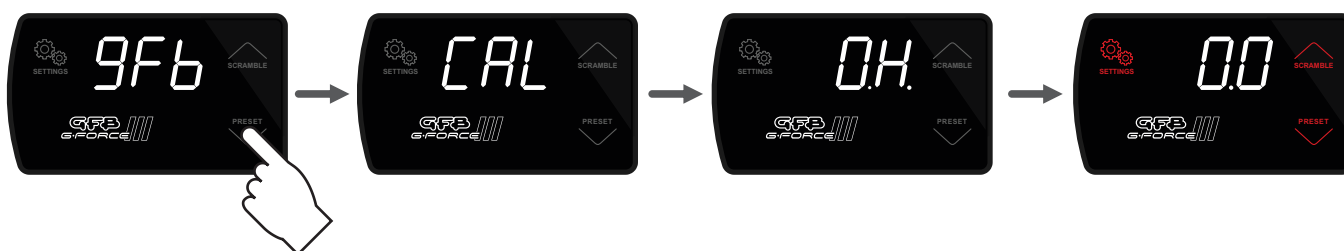

COLOUR SETTINGS

Colour allows you to configure the button colours - both the normal “background” colour (i.e. when not pressed), and also the “feature active” colour, which is the colour a button turns when either scramble or preset features are activated (see pages 7 and 11).

There are seven options available:

- Red
- Green
- Blue
- Aqua (green/blue)
- Purple (red/blue)
- Yellow (green/red)
- Off (no light)

“Off” is provided as an option, which could be used for example if you don’t want the buttons lit at night, but still want a visual indication when scramble is activated.

Within the **Colour** menu, tap “DOWN” to scroll through the “background” colour options - you will see the buttons change colour as you do this - the display screen will not change.

Tap “UP” to scroll through the “active” colour options - you will see the button you are tapping briefly change colour, indicating what the buttons will change to when activated.

Example 1: Changing “background” colours

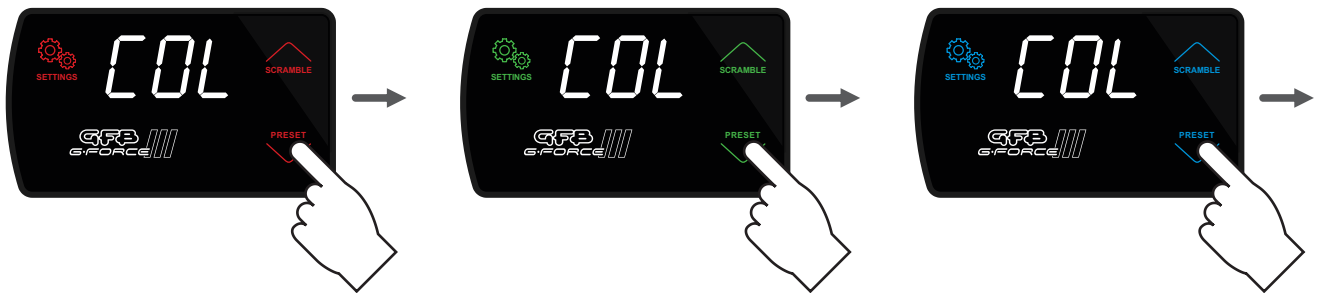

Example 1: Changing “feature active” colours



- From **Running Mode**, use the “SETTINGS” button to navigate to the **Colour** setting (display shows “COL”)
- Use the “UP/DOWN” buttons to make your selection as described above
- Tap “SETTINGS” to save and move to the next menu item, or hold “SETTINGS” to save and exit to **Running Mode**

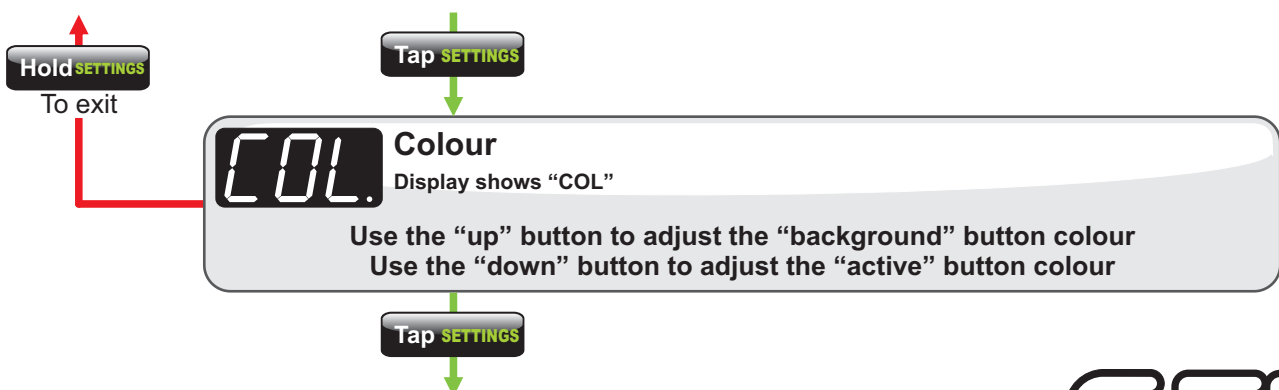

TIPS

Here are some handy suggestions for different ways you can set up and use the features on your G-Force III.

If you set the "IN.1" menu item to "SCr" (scramble), then you can use the blue external input wire to trigger scramble in a variety of different ways to achieve different outcomes.

For example, you can connect the external input wire to:

- Steering wheel button - easy access to use as a "push-to-pass" system. You can drive normally on low boost and access high boost immediately when required (or when you have traction). If you set the scramble seconds to 0, it will return to low boost as soon as the button is released, or you can have it time out after a few seconds.
- Throttle switch - using a micro-switch on the throttle pedal (like a "kick-down" switch), or a configured output from an aftermarket ECU, you can make the scramble feature activate when the throttle is floored, for an "automatic" version of "push-to-pass" - i.e. you get high boost when you need it simply by flooring the throttle.
- Brake/handbrake switch - you can activate high boost after a certain amount of time has passed during a drag race to aid traction off the line. In this case, you would set the scramble boost preset to a lower boost setting for launch, and set the scramble seconds to whatever time you want to engage the high boost setting (i.e. when scramble times out). So when you are staging, the brake pedal/handbrake is held and scramble is active on a low boost preset. When the brake is released and the run begins, the scramble timer starts and will turn off after the chosen amount of time, reverting back to the original (high) boost preset.
- Toggle switch - use a toggle (on/off) switch instead of a momentary button (press and release) to keep scramble activated as long as the switch is on. This method gives you easy high/low boost selection, perhaps useful if you need to fill the car with low octane fuel and the toggle switch gives you a good visual reminder that you're in low boost.
- Warning light or programmable output from ECU - if you have other warning devices such as a knock light, low water level (for water injection/intercooler spray), high intake air/water/oil/transmission temperature, you could use such a warning light or programmable ECU output to activate scramble to a lower boost pressure to help protect the engine.

If you set the "IN.1" menu item to "bOOST" (boost preset selection), every time you activate the external input, the controller jumps to the next boost preset.

This can be used to set up a kind of "boost-by-gear" feature for drag racing situations. You would connect the external input to a clutch switch or gear selector switch in such a way that it triggers with each gearshift. Then, when you stage your car, manually select boost preset 1 using the buttons on the G-Force III, and then each time you shift gears after your launch, the external input on the clutch or gear selector will activate the next boost preset. Since there are 6 boost presets, you can tailor the peak boost, rise rate and taper for each gear.

TROUBLESHOOTING

The buttons appear to be locked:

If the boost gauge is currently reading higher than zero, the menu is locked out and the scramble/preset buttons do still work, but the display will not change to register a button press. If the engine is off and the gauge is still showing higher than zero, re-calibrate the gauge - see page 15.

The solenoid buzzes constantly with the ignition on when the engine isn't running:

As above, it's likely that the gauge is showing higher than zero, and hence the controller is attempting to regulate boost. Re-zero the gauge as per page 15. Also, hit SETTINGS once to check that the duty cycle menu shows a recorded peak boost. If peak boost is 0, your gain function isn't working and the solenoid starts pulsing from just above zero.

With the engine off, the gauge does not show zero:

Perform a boost gauge calibration, as described on page 15.



Boost pressure remains the same regardless of the duty cycle setting:

Turn the ignition off, then on again and listen for the solenoid to click rapidly for about 1 second. If you can't hear it click on power up, check the wiring loom to the solenoid valve.

If the solenoid does click rapidly on power up, check the hose connections to the solenoid valve and wastegate - make sure the un-used solenoid valve port is not plugged, and that the boost pressure and wastegate hoses are connected to the right ports.

Check the controller is receiving full battery voltage. If it is powered from a low voltage supply, the display will work but the solenoid will not.

The peak boost pressure always seems to be higher than the target that was originally set:

The car may not have been driven in a way that achieved the "true" peak boost whilst duty cycle was being set up. Go back into **Duty Cycle** and either reduce the duty cycle value so that peak boost comes down to where you want it, or leave the duty cycle alone and drive the car again to learn the "true" peak boost.

Boost pressure spikes (overshoots the target):

Reduce the **Gain** setting

Boost spiking should not be confused with boost taper (see below). Boost taper often looks similar to spiking in low gears because the RPM increases so quickly.

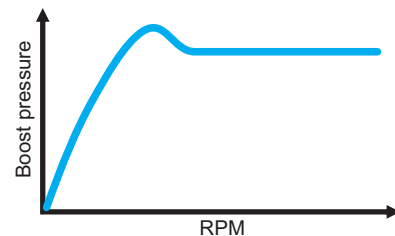

Boost pressure oscillates significantly:

Reduce the **Sensitivity** setting

If the closed-loop taper correction is set too high, the boost may fluctuate rapidly up and down, which is a sign that the system is going "unstable". It means the correction is too strong, and whilst a weaker setting will eliminate the instability, boost will likely still drop off a little because the turbo is nearing its limits (see boost taper below).

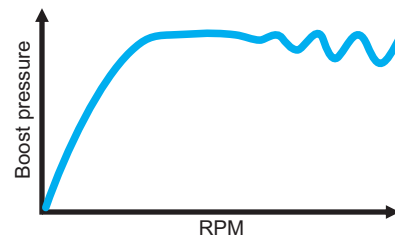

Boost tapers off even with a high Sensitivity setting

Check that the boost preset you are using has a recorded peak boost by pressing **SETTINGS** once to go into the duty menu, and read the peak value. If it is 0, the Sensitivity feature will not function, and a peak value should be recorded.

If a peak boost is recorded and boost is still tapering, this is a sign that the turbo system is operating beyond its efficient limits. Either the turbo is too small to hold high boost to redline, or the wastegate spring is too soft. If you are using a duty cycle of more than 70%, it's possible that a stronger wastegate spring and lower duty cycle will hold a more stable boost pressure.

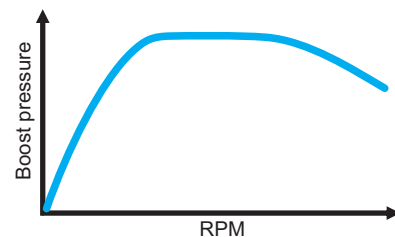

Boost pressure starts to increase significantly at high RPM:

This is called boost creep, which is a result of the wastegate not being large enough. It may hold boost stable for some of the rev range, but at high RPM it is wide open and not flowing enough to prevent boost from rising further. At this point the G-Force III can do no more, the only solution is a larger wastegate.

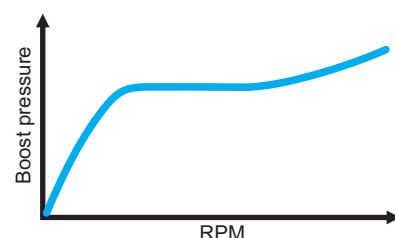

Duty Cycle - what the heck is it?

Duty cycle refers to how the solenoid valve is actually controlled. The G-Force III boost controller outputs a signal to the solenoid valve that rapidly pulses it on and off about 30 times a second (0.033 seconds per cycle) to bleed air from the wastegate, and duty cycle alters how long it is on for each cycle, and how long it is off.

For example, a duty cycle of 25% means that the solenoid valve is pulsed ON for 25% of each cycle, and OFF for 75% of the cycle. A 25% duty cycle output from the G-Force to the solenoid valve is illustrated opposite:

The higher the duty cycle, the longer the solenoid is pulsed on each cycle, which bleeds more air from the wastegate actuator, resulting in a higher boost pressure.

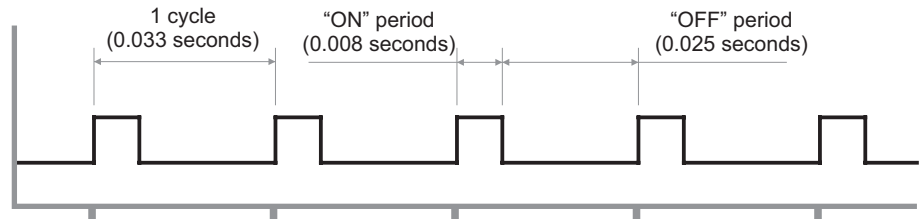

Duty Cycle limits

Running 10% duty cycle means that the solenoid is effectively off and all of the pressure gets to the wastegate, which is the same as having no boost controller, and the turbo will run the minimum pressure (aka "gate" pressure) possible.

Running the solenoid at 100% duty cycle prevents ALL of the pressure from getting to the wastegate, which is effectively the same as removing the hose from the wastegate altogether, which results in the highest boost pressure the turbo is capable of supplying.

Why can't I just dial-in how much boost I want instead of fiddling with duty cycle?

Fair question. Unfortunately, the G-Force III (or any boost controller for that matter) doesn't know what boost pressure your specific turbo/wastegate/engine/weather conditions/etc will return for a given duty cycle - there simply is no formula that says "for this turbo on that car, 'X'% duty cycle will give 'Y'psi of boost".

The controller NEEDS to know this relationship between duty cycle and resulting boost pressure, because when boost is rising quickly, it must pulse the solenoid at the correct duty cycle **BEFORE** the boost reaches the target boost pressure. If it doesn't know the correct duty cycle, it cannot do this.

The reason it must pulse the solenoid before boost reaches the target is because there is always a small delay between the controller making a change to the duty cycle, and the wastegate (and therefore boost pressure) responding to the change. This delay means that if the controller simply waited until the boost pressure reached the target and then responded accordingly, boost pressure would overshoot the target.

Therefore, the only way to determine the duty cycle/boost relationship is through trial-and-error, by starting at a low duty cycle, reading the resulting boost pressure, and increasing it until you reach the desired boost.

Once the G-Force III knows the duty cycle that results in the target boost pressure, it can then make changes to the duty cycle to compensate for small variations in boost (when a value for "Sensitivity" has been entered).

WARRANTY

All products manufactured or distributed by Go Fast Bits P/L are subject to the following Limited Express Warranties, and no others:

For a period of one year from and after the date of purchase of a new Go Fast Bits product, Go Fast Bits warranties and guarantees only to the original purchaser/user that such a product will be free from defects of material and/or workmanship in the manufacturing process. Go Fast Bits, at its sole discretion, shall replace or repair a defective product. This express warranty shall be inapplicable to any product not properly installed or properly used by the purchaser/user or to any product damaged or impaired by external forces. This is the extent of warranties available on this product. Go Fast Bits shall have no liability whatsoever for consequential damages following from the use of any defective product or by reason of failure of any product. Go Fast Bits specifically disclaims and disavows all other warranties express or implied including, without limitation, all warranties of fitness for a particular purpose, warranties of description, warranties of merchantability, trade usage or warranties of trade usage.