

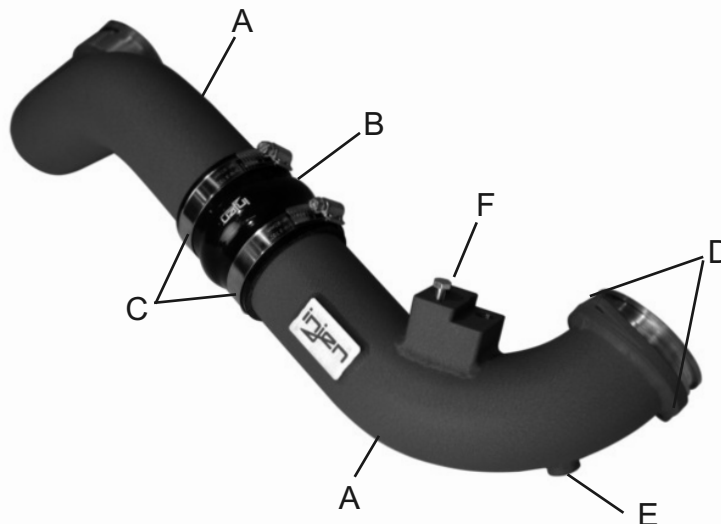

Vehicle Application:  
 Make: **Toyota**  
 Model: **SupraA90/A91**  
**(Not CARB approved)**  
 Year: **2020-2023**  
 Engine: **3.0L L6 Turbo**  
 Make: **BMW**  
 Model: **Z4**  
**(Not CARB approved)**  
 Year: **2020-2023**  
 Engine: **3.0L L6 Turbo**



Item	QTY.	P/N	Description
A	1	W-SES2300ICP	2 piece charge pipe
B	1	#3193	2-3/4" hump hose
C	2	#4003	#40 clamps
D	2	#6056	M6 socket cap screws
E	1	#8054	1/8" NPT Plug
F	1	#6005	M6 hex screw

- TOOLS REQUIRED**
- 10mm Ratchet & Socket
  - 8mm nut drive
  - Allen key
  - Flat Blade Screwdriver
  - Phillips Screwdriver

**WARNING:** FAILURE TO FOLLOW INSTALLATION INSTRUCTIONS AND NOT USING THE PROVIDED HARDWARE MAY DAMAGE THE CHARGE PIPE, ENGINE AND COMPONENTS!!!  
**\*Do not attempt to install the intake system while the engine is hot.**  
 Severe burn could result from touching hot engine components!

Report any defective or missing parts to the authorized Injen dealer you purchased this product from. Before installing any parts of this system, please read the instructions thoroughly. If you have any questions regarding installation, please contact your Injen Technology dealer. Installation DOES require some mechanical skills. A qualified mechanic is always recommended.

A Limited Lifetime Warranty to the original purchaser against defects in material and workmanship on all Injen intake systems excluding the filter element. Any and all warranty coverage is limited to the repair or replacement of the defective part only, at Injen Technology's discretion. The warranty does not cover incidental or consequential damages, nor does it cover the cost of installation or removal of the defective part or its replacement. Proof of purchase is required.

# Instruction Manual P/N:SES2300ICP

**NOTE:** This intake kit may not work on vehicles with the following aftermarket modifications.

- Aftermarket Intercooler piping
- Aftermarket intercooler
- Turbo upgrade
- Modified body panels
- Suspension & Chassis modifications

Injen intake systems are street legal in most states unless the state is adopting to California Emissions standards. States that have adopted California emission standards include: Arizona, California, Connecticut, District of Columbia, Maine, Maryland, Massachusetts, New Jersey, New Mexico, New York, Oregon, Pennsylvania, Rhode Island, Vermont, and Washington. These states will require an California Air Resource Board Executive Order Number (CARB E.O.) for the legal use of an Injen intake system in your vehicle for use on public roads or highways. These vehicle will be considered "Legal in California only for racing vehicles competition use only, which may never be used upon a public street or highway. **Please keep your factory air box assembly for any future use.**



The SuperNano-Web filter media is a dry synthetic media that outperforms the competition. The media itself is a proprietary base blend of synthetics and cellulose. Cellulose fibers are larger than synthetic fibers, and have larger spaces between the fibers, causing contaminants to load in the depth of the media and plug the airflow path. This creates higher restriction levels and less capacity. The synthetic fibers in the SuperNano-Web media are submicron in diameter and have small interior fiber spaces, which result in more contaminants being captured on the surface of the media. This can help keep restriction levels low as the filter loads with dirt and containments

If you look at the picture to the left, you can see the Nano-fiber web on top of our base media. That web, or SuperNano-Web as we like to call it, helps trap smaller particles and protect your engine.

### **To Clean your filter:**

Carefully remove the filter from the housing. Once removed, wipe down the housing using a clean shop towel, being careful not to knock any dirt and/or debris in the air inlet. Your filters can be cleaned by carefully vacuuming the filter media from the dirty side, or by holding the filter with one hand and carefully blowing the filter media at a 45-degree angle from the clean side using low-pressure shop air (15-20 lbs. psi).

***\*IT IS IMPORTANT TO NOT USE ANY CLEANERS ON THE SUPERNANO-WEB MEDIA OR APPLY ANY OIL!!!***

**NOTE: DISCONNECT BATTERY BEFORE INSTALLATION!!!**

# Instruction Manual P/N:SES2300ICP



1. Stock charge pipe shown. Remove the engine cover. Remove the stock intake system out of vehicle for easier installation.

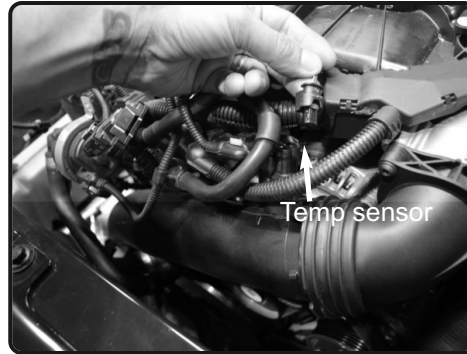

2. Disconnect the temperature harness.

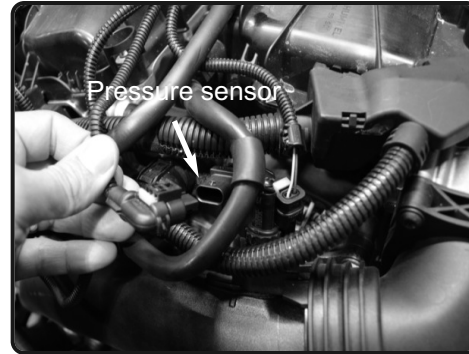

3. Disconnect the pressure sensor harness.

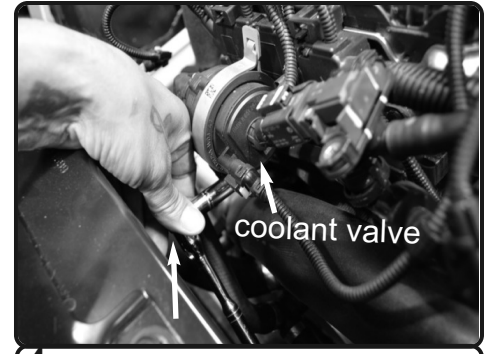

4. With 10mm socket or wrench. Loosen the bracket holding in the coolant valve.

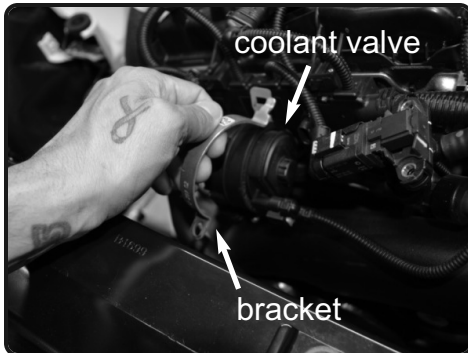

5. Carefully pull back the bracket, and move the coolant valve for removal of the OEM charge pipe. Disconnect the harness. **Do not disconnect, valve has coolant.**

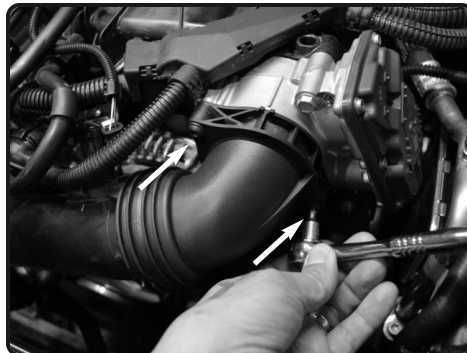

6. With T30 torx bit, loosen the 2 screws holding in the OEM charge pipe on the throttle body.



7. Pull back the OEM charge pipe from the throttle body.

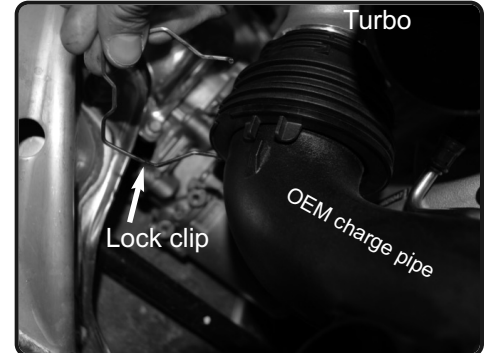

8. With pliers or flat head screwdriver, carefully pull back the lock clip on turbo side of the OEM charge pipe. Save lock clip for later install.

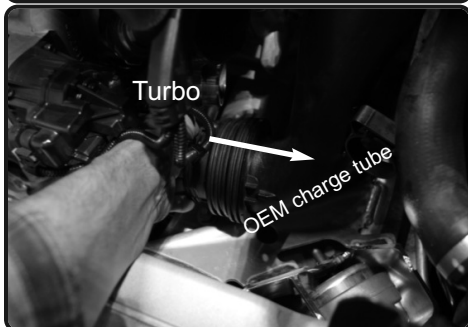

9. Slide the OEM charge pipe out from the turbo.

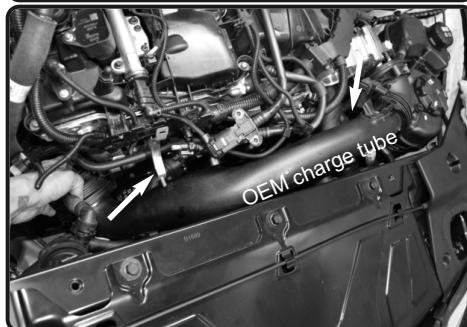

10. Carefully route the OEM charge pipe out through the top of the engine compartment. Maneuver for easiest removal.



11. Remove the OEM charge pipe from the vehicle.



12. Loosen and remove the pressure sensor from the OEM charge pipe using T25 torx bit.

# Instruction Manual P/N:SES2300ICP



**13.** Carefully un-screw the temperature sensor out of the vehicle.



**14.** With a small flathead screwdriver, carefully remove the upper OEM O Ring out of the vehicle.



**15.** Now install the OEM O Ring into the new charge pipe machined fitting.

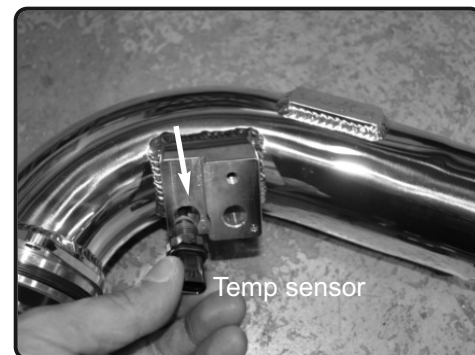

**16.** Install and secure the temperature sensor into the new machined adaptor. Secure and tighten. *Make sure the seal is seated.*

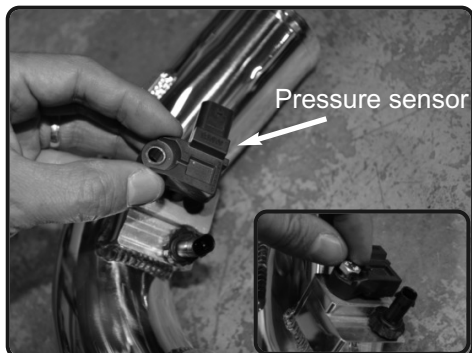

**17.** Install the pressure sensor into the machined adaptor and secure using provided M6 hex screw.



**18.** Tighten the hex screw using 10mm socket or wrench.

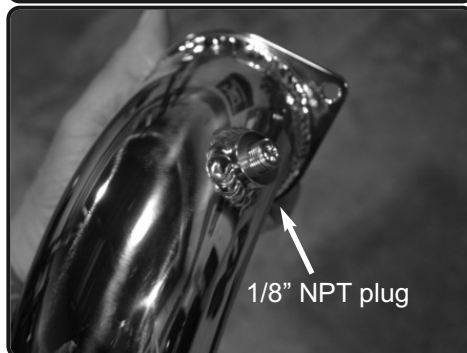

**19.** Install the 1/8" NPT plug to the threaded machined fitting on the charge pipe if not using.



**20.** Secure and tighten using allen key.



**21.** Carefully with a small flathead screwdriver, remove the OEM O Ring from the lower end of the OEM charge pipe.



**22.** Remove the OEM O Ring from the charge pipe.



**23.** Install the OEM O ring into the new injen charge pipe machined flange. *Make sure the O Ring is seated properly.*



**24.** Re-install the lock clip from step 8 to the the new injen charge pipe machined flange.



**25.** Bottom flange assembly shown. Make sure the lock clip is seated correctly.

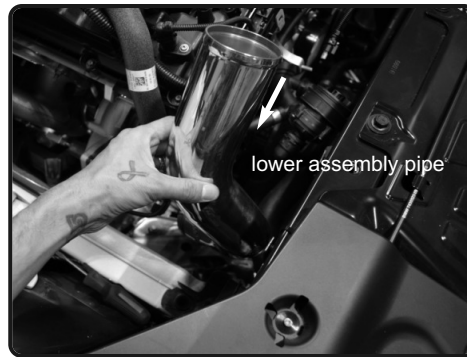

**26.** Install the lower assembly pipe into the vehicle and position.

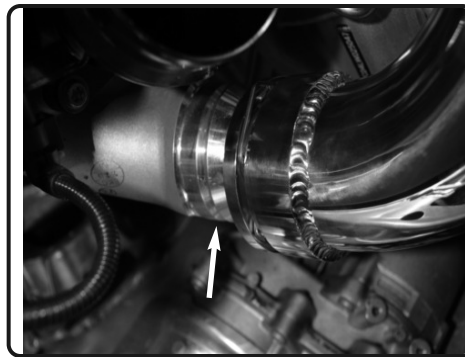

**27.** Position the flange on to the turbo.



**28.** Push until you hear a click. Once seated properly, pull back and tug on pipe to make sure the flange is secured and locked.

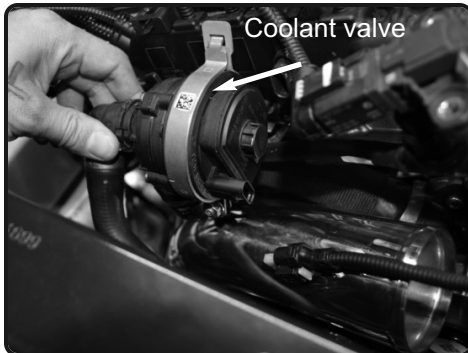

**29.** Re-install the bracket and secure the coolant valve. Re-connect any harness.



**30.** Install the 2-3/4" hump hose to the lower pipe.



**31.** Tighten the clamp on the lower pipe only.

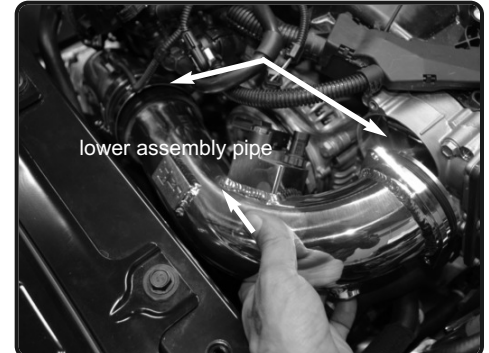

**32.** Now install the upper pipe assembly into the vehicle and position to the hump hose and the throttle body.

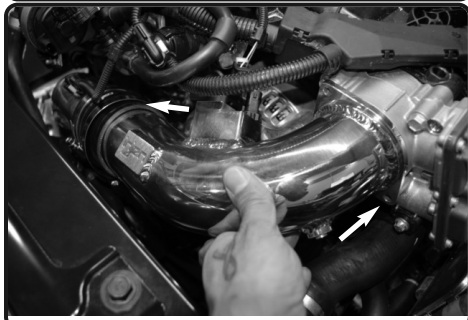

**33.** Adjust for proper fitment.



**34.** Secure the throttle body using provided socket cap M6 screws. Tighten using allen key.



**35.** Tighten the clamp on the hump hose using 8mm nut driver.



**36.** Locate the harness that connects the temp and pressure sensor. Unclip the harness from the engine. This will give you more harness length.

# Instruction Manual P/N:SES2300ICP



**37.** Route the harness to your desired position.

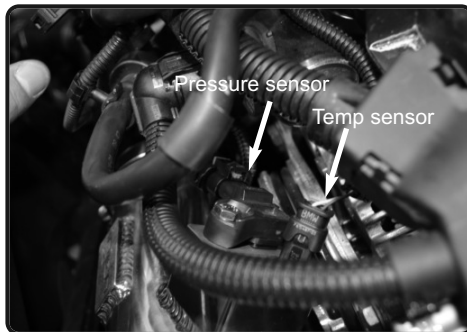

**38.** Reconnect the Temperature sensor and pressure sensor harness.

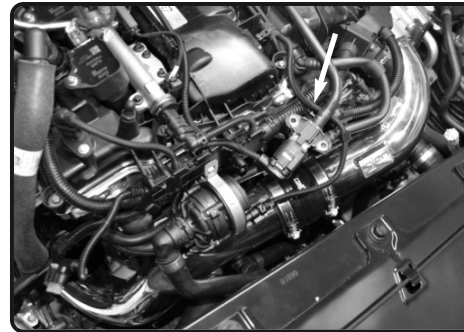

**38.** Verify all components are secured and tighten. Check all harness that were disconnected. Re-adjust if fitment needs to be adjusted.



Congratulations! You have just completed the installation of this intake system. Periodically, check the alignment of the intake, normal wear and tear can cause nuts and bolts to come loose. **Note: Check clearance and adjust if needed! Failure to check the alignment and adjust the intake can cause damage that will void the warranty. Injen Technology is not responsible for any damages caused by/from improper installation.**

## Test Drive:

1. With the transmission in neutral or park and the parking brake engaged, start the engine. Listen for air leaks or odd noises. If air leaks are detected, secure hoses and connections. For any odd noises, inspect entire system for cause and adjust intake as needed. The Injen intake will function identically to the factory system but will be louder and more powerful.
2. Perform a road test. Listen for odd noises or rattles and fix as necessary.
3. If there are no issues, continue to enjoy your added performance from the Injen performance Intake kit.
4. Injen Technology recommends you periodically check clearance and adjust if needed! Failure to check the alignment and adjust the intake can cause damage that will void the warranty. Injen Technology is not responsible for any damages caused by/from improper installation.

1. Upon completion of the installation, reconnect the negative battery terminal before you start the engine.
2. Align the entire intake system for the best possible fit. Once the intake has been properly fitted continue to tighten all nuts, bolts and clamps.
3. Periodically, recheck the alignment of the intake system and make sure there is proper clearance around and along the length of the intake. Failure to follow proper maintenance procedures may cause damage to the intake and will void the warranty.
4. Start the engine and listen carefully for any odd noises, rattles and/or air leaks prior to taking it for a test drive. If any problems arise go back and check the vacuum lines, hoses and clamps that maybe causing leaks or rattles and correct the problem.
5. Check the filter for excessive dirt build up. Clean or replace the filter with an original Injen filter (can be bought on-line at "injenonline.com"). Congratulations! You have just completed the installation of the best intake system sold on the market. Enjoy the added power and performance of your new intake system.