

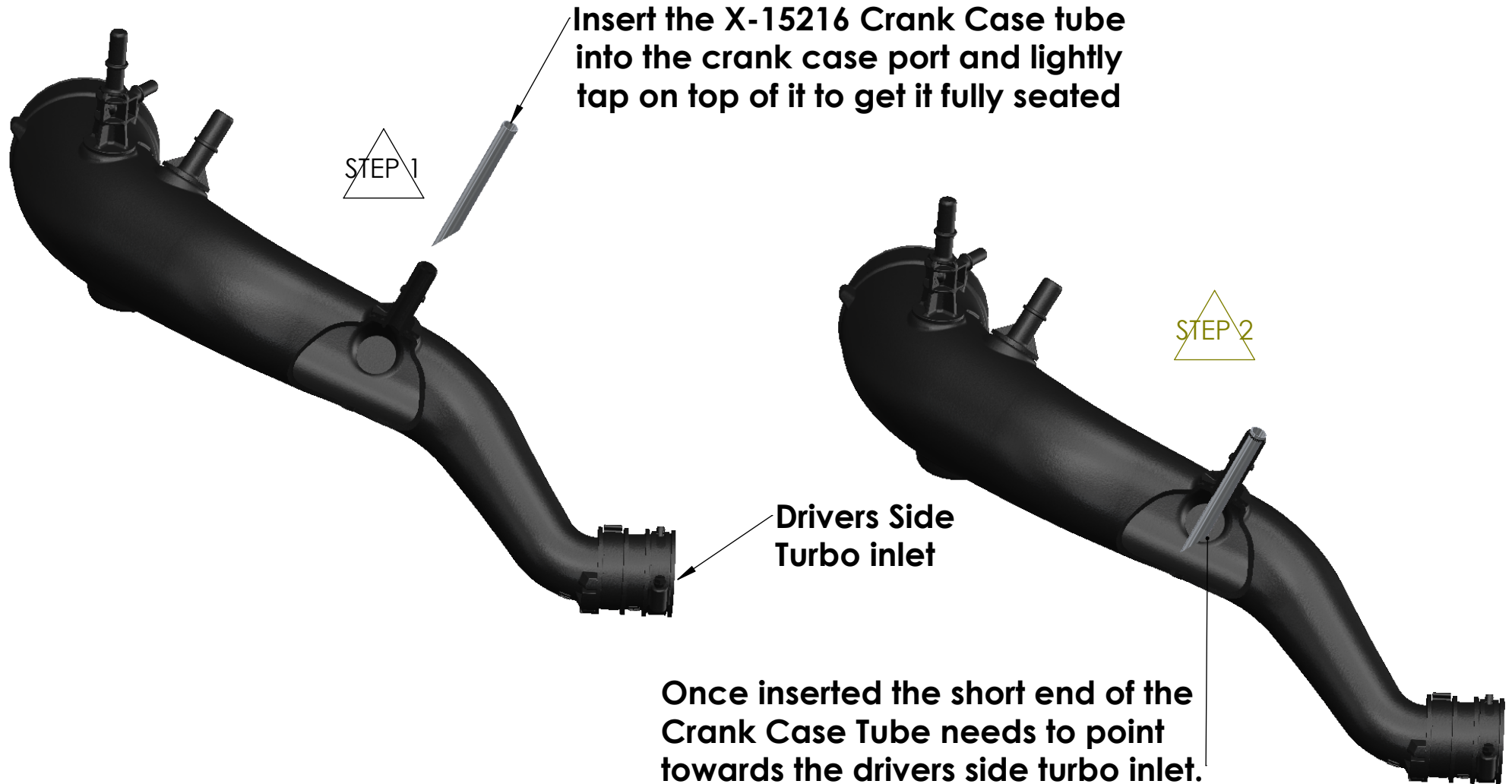

**NOTE:** X-15216 Crank Case Tube must be installed into the lower OEM drivers side turbo intake tube to avoid CEL. Rotate a few degrees clockwise/counter clockwise if CEL appears after installation.



TITLE:		NAME	DATE	INTERPRET GEOMETRIC TOLERANCING PER: ASME Y14.5	VEHICLE APPLICATIONS:	 <p>[O] 909.839.0706 [F] 909.839.0427 244 Pioneer Place Pomona, CA 91768 www.injen.com</p>	
DRAWN				UNLESS OTHERWISE SPECIFIED:	<p><b>PROPRIETARY AND CONFIDENTIAL</b> THE INFORMATION CONTAINED IN THIS DRAWING IS THE SOLE PROPERTY OF INJEN TECHNOLOGY. ANY REPRODUCTION IN PART OR AS A WHOLE WITHOUT THE WRITTEN PERMISSION OF INJEN TECHNOLOGY IS PROHIBITED.</p>		
CHECKED							
MATERIAL							
SIZE	DWG. NO.	REV	FINISH	DIMENSIONS ARE IN INCHES TOLERANCES: FRACTIONAL: $\pm 1/16"$ ANGULAR: MACH $\pm 1^\circ$ BEND $\pm 1^\circ$ TWO PLACE DECIMAL $\pm .01$ THREE PLACE DECIMAL $\pm .005$	SCALE: 1:8	WEIGHT:	SHEET 1 OF 1
<b>A</b>			DO NOT SCALE DRAWING				

# Front of vehicle

REVISIONS			
REV.	DESCRIPTION	DATE	APPROVED

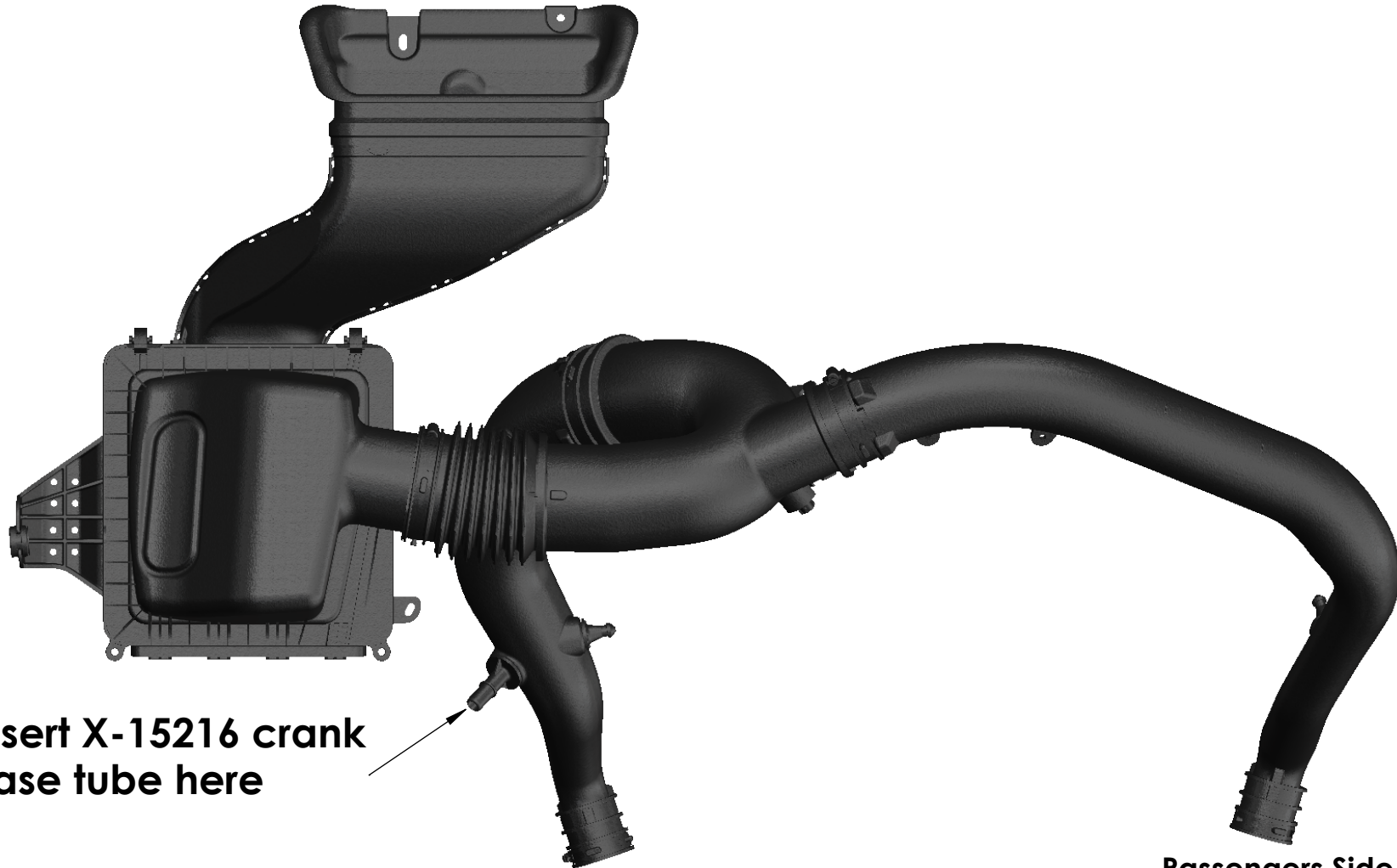

Insert X-15216 crank case tube here

Drivers Side Turbocharger Inlet

Passengers Side Turbocharger Inlet

TITLE:		NAME		DATE		INTERPRET GEOMETRIC TOLERANCING PER: ASME Y14.5		VEHICLE APPLICATIONS:		 <p>[O] 909.839.0706 [F] 909.839.0427 244 Pioneer Place Pomona, CA 91768 www.injen.com</p>
DRAWN						UNLESS OTHERWISE SPECIFIED:				
CHECKED										
MATERIAL										
SIZE	DWG. NO.	REV	FINISH	DIMENSIONS ARE IN INCHES		TOLERANCES:				<p><b>PROPRIETARY AND CONFIDENTIAL</b> THE INFORMATION CONTAINED IN THIS DRAWING IS THE SOLE PROPERTY OF INJEN TECHNOLOGY. ANY REPRODUCTION IN PART OR AS A WHOLE WITHOUT THE WRITTEN PERMISSION OF INJEN TECHNOLOGY IS PROHIBITED.</p>
<b>A</b>				FRACTIONAL ± 1/16"		ANGULAR: MACH ± 1° BEND ± 1°				
DO NOT SCALE DRAWING				TWO PLACE DECIMAL ± .01		THREE PLACE DECIMAL ± .005				
SCALE: 1:24		WEIGHT:		SHEET 1 OF 1						



**Vehicle Application:**  
 2015-2023 Ford F-150 2.7/3.5L Twin Turbo  
 2017-2023 F-150 Raptor 3.5L Twin Turbo  
 2018-2023 Ford Expedition 3.5L Twin Turbo  
 2018-2023 Lincoln Navigator 3.5L Twin Turbo

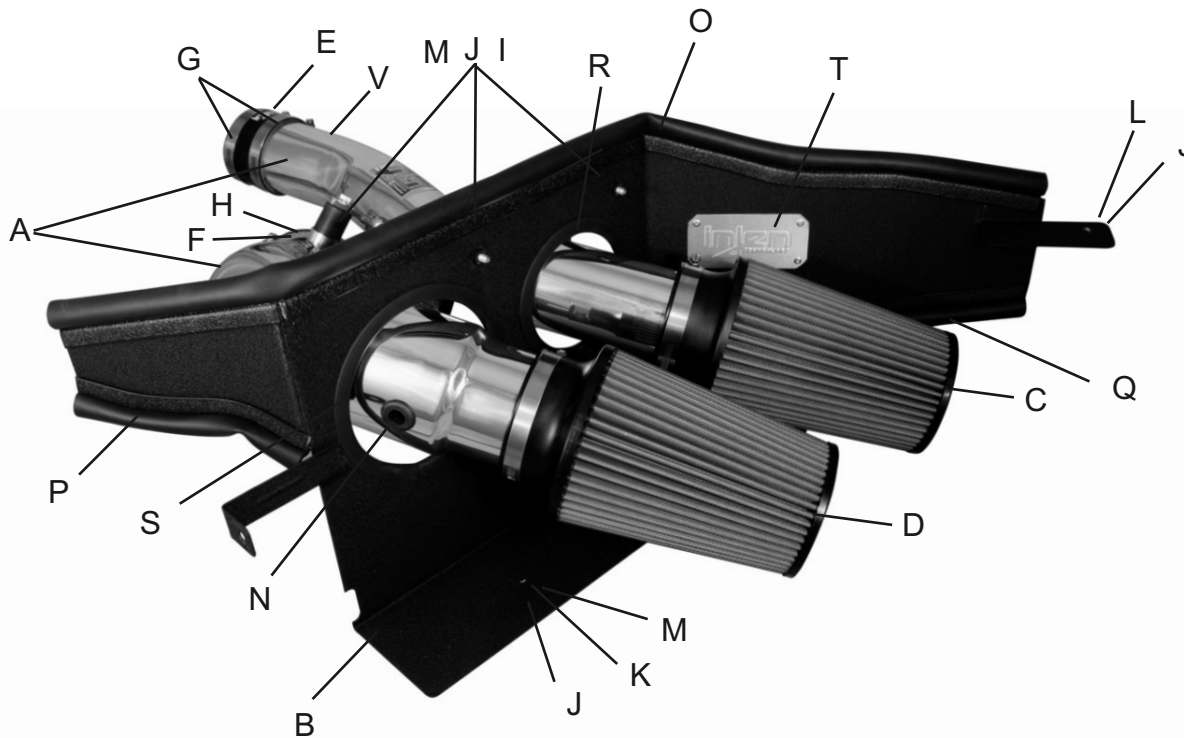

Item	QTY.	P/N	Discription
A	1	Y-PF9015	Intake Tubes
B	1	#11123	Heat Shield
C	1	#1078	3.0" Web Nanofiber Dry filter
D	1	#1079	3.5" Web Nanofiber Dry filter
E	1	#3044	3.0" straight hose
F	1	#3219	4" elbow hose
G	2	#4004	#48 clamps
H	2	#4006	#64 Clamps
I	3	#6020	M6 vibramounts
J	5	#6010	Fender washers
K	1	#15023	M6 Stand-off stud
L	1	#6056	M6 socket cap screw
M	4	#6002	M6 nuts
N	1	#8002	Grommet
O	1	#6058	Rubber bulb trim @ 33" Length
P	1	#6058	Rubber bulb trim @ 7.5" Length
Q	1	#6058	Rubber rubber trim @ 11.5" Length
R	1	#6023	Rubber trim @ 15" Length
S	1	#6023	Rubber trim @ 19" Length
T	1	#11097	injen badge
U	1	X-15216	Crank case tube
V	1	x-6015	Grommet plug

**WARNING:** FAILURE TO FOLLOW INSTALLATION INSTRUCTIONS AND NOT USING THE PROVIDED HARDWARE MAY DAMAGE THE INTAKE SYSTEM, ENGINE AND COMPONENTS!!!  
\*Do not attempt to install the intake system while the engine is hot.  
 Severe burn could result from touching hot engine components!

- TOOLS REQUIRED**
- 10mm Ratchet & Socket
  - 8mm nut drive
  - Allen key
  - Phillips Screwdriver

Report any defective or missing parts to the authorized Injen dealer you purchased this product from. Before installing any parts of this system, please read the instructions thoroughly. If you have any questions regarding installation, please contact your Injen Technology dealer. Installation DOES require some mechanical skills. A qualified mechanic is always recommended.

A Limited Lifetime Warranty to the original purchaser against defects in material and workmanship on all Injen intake systems excluding the filter element. Any and all warranty coverage is limited to the repair or replacement of the defective part only, at Injen Technology's discretion. The warranty does not cover incidental or consequential damages, nor does it cover the cost of installation or removal of the defective part or its replacement. Proof of purchase is required.

# Instruction Manual P/N:PF9015

**NOTE:** This intake kit may not work on vehicles with the following aftermarket modifications.

- Aftermarket Intercooler piping
- Aftermarket intercooler
- Turbo upgrade
- Modified body panels
- Suspension & Chassis modifications

Injen intake systems are street legal in most states unless the state is adopting to California Emissions standards. States that have adopted California emission standards include: Arizona, California, Connecticut, District of Columbia, Maine, Maryland, Massachusetts, New Jersey, New Mexico, New York, Oregon, Pennsylvania, Rhode Island, Vermont, and Washington. These states will require an California Air Resource Board Executive Order Number (CARB E.O.) for the legal use of an Injen intake system in your vehicle for use on public roads or highways. These vehicle will be considered "Legal in California only for racing vehicles competition use only, which may never be used upon a public street or highway. **Please keep your factory air box assembly for any future use.**



The SuperNano-Web filter media is a dry synthetic media that outperforms the competition. The media itself is a proprietary base blend of synthetics and cellulose. Cellulose fibers are larger than synthetic fibers, and have larger spaces between the fibers, causing contaminants to load in the depth of the media and plug the airflow path. This creates higher restriction levels and less capacity. The synthetic fibers in the SuperNano-Web media are submicron in diameter and have small interior fiber spaces, which result in more contaminants being captured on the surface of the media. This can help keep restriction levels low as the filter loads with dirt and containments

If you look at the picture to the left, you can see the Nano-fiber web on top of our base media. That web, or SuperNano-Web as we like to call it, helps trap smaller particles and protect your engine.

### **To Clean your filter:**

Carefully remove the filter from the housing. Once removed, wipe down the housing using a clean shop towel, being careful not to knock any dirt and/or debris in the air inlet. Your filters can be cleaned by carefully vacuuming the filter media from the dirty side, or by holding the filter with one hand and carefully blowing the filter media at a 45-degree angle from the clean side using low-pressure shop air (15-20 lbs. psi).

***\*IT IS IMPORTANT TO NOT USE ANY CLEANERS ON THE SUPERNANO-WEB MEDIA OR APPLY ANY OIL!!!***

**NOTE: DISCONNECT BATTERY BEFORE INSTALLATION!!!**

# Instruction Manual P/N:PF9015



1. Stock intake system shown.

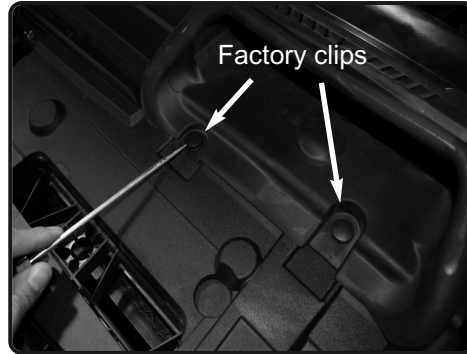

2. Remove the two plastic retaining rivets from the air scoop and remove scoop from engine bay.

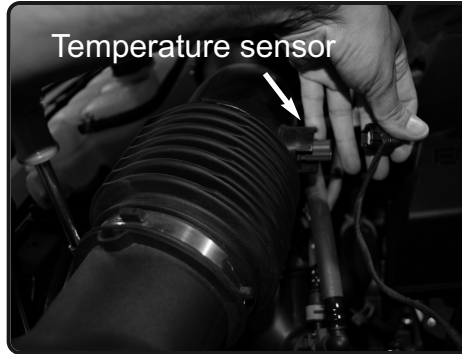

7. Disconnect the temperature sensor harness.



3. Loosen the 3 clamps on the stock intake tube using 7mm nut driver.



4. Un-clip the upper half of the air box attached to bottom of air box. Remove stock assembly out of vehicle.

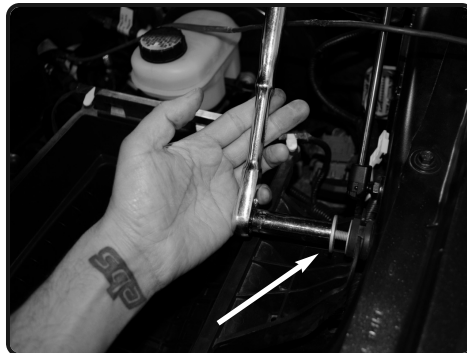

5. Loosen the bolt holding in the bottom of the airbox using 13mm socket or wrench.

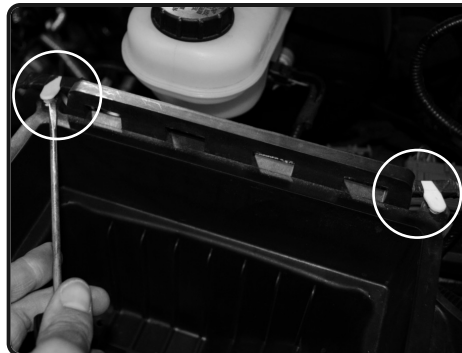

6. Pull back the temperature harness from the air box.



7. Now lift up and remove the bottom half of air box out of vehicle.



8. Loosen and remove the temperature sensor out of stock intake. Use a small flat head screwdriver to pull back clip on sensor.



9. Locate the bolt holding in the radiator support. Loosen bolt using 13mm socket and ratchet. Save bolt for later install.

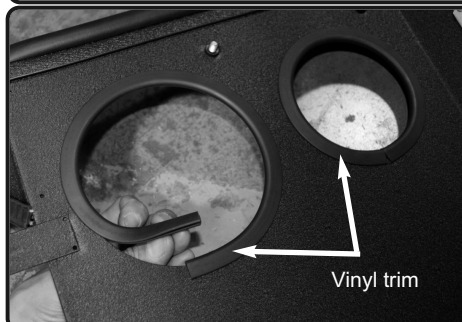

10. Install the vinyl trim to holes on heat shield. 19" to larger hole and 15" to smaller hole.

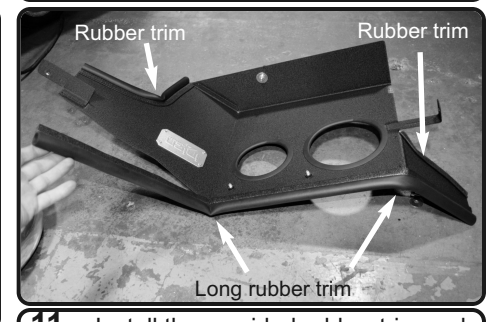

11. Install the provided rubber trim and vinyl trim to heat shield. See above for correct position. **Note: longer rubber trim, notch for easy corner installation.**

# Instruction Manual P/N:PF9015



**12.** Locate the stock air box grommet in above image. Install the stand off stud to the grommet and secure.

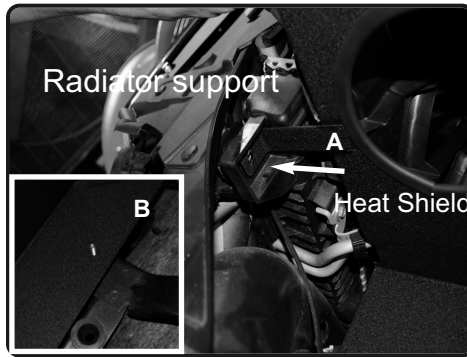

**13.** A) Install the heatshield into the vehicle and position bracket to the front radiator support. Secure using bolt from step 9. Tighten and secure. B) Now install the bottom of the heat shield hole to the stand off stud..

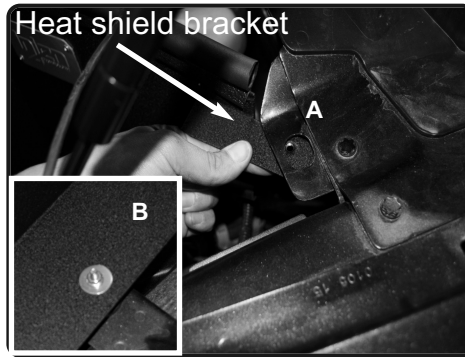

**14.** A) Now install the bracket on heat shield to the front clip located on fire wall. Make sure bracket sits under clip. Secure using provided M6 socket cap screw and fender washer. B) Secure the stand off stud using provided M6 nut and fender washer.

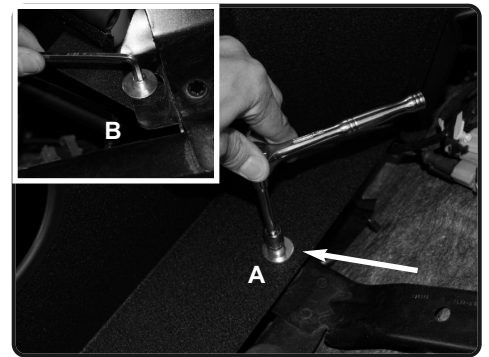

**15.** A) Now secure and tighten using 10mm socket and ratchet. B) Secure the bracket using allen key.

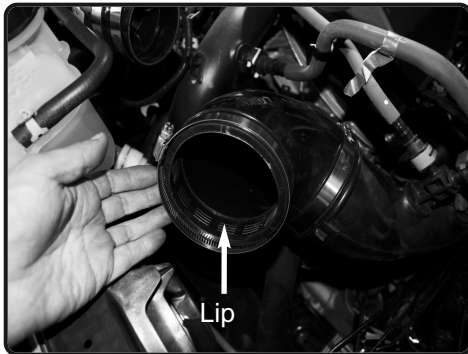

**16.** Now install the 4" elbow with clamps provided to the large turbo housing side. Make sure the side with no lip is installed on the housing. Position like image above.



**17.** Install the 3" straight hose with clamps provided to the secondary turbo housing. Tighten the clamp on housing only using 8mm nut driver.

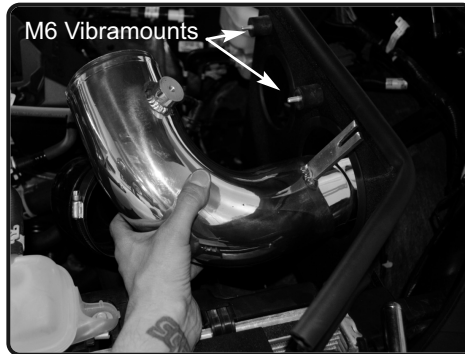

**18.** Install two vibramount to the threaded inserts on heat shield. Install the large intake pipe, make sure the 3.5" side goes through heat shield. Position the bracket to the vibramount and tube to 4" elbow. Do not tighten.

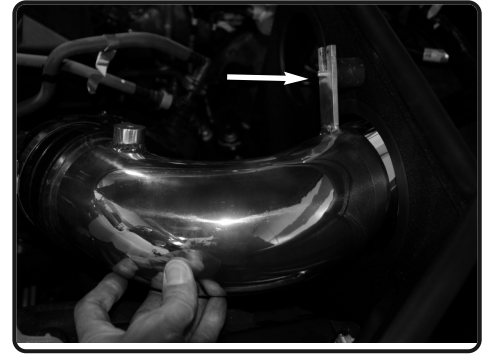

**19.** Position for the best fit, make sure the elbow fits in the natural position for best fit and clearance. **Note: see last page for crankcase tube installation.**



**20.** Secure the bracket using provided m6 nut and fender washer tighten using 10mm socket and ratchet. Tighten clamps using 8mm nut driver.

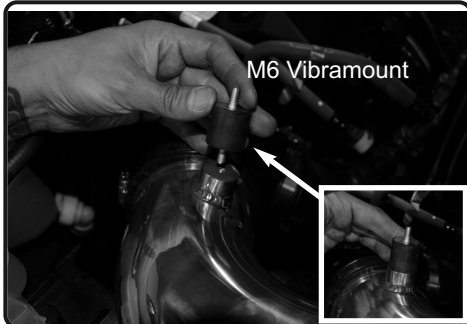

**21.** Install the vibramount to the welded fitting on intake tube, secure the vibramount and tighten.



**22.** Now install the smaller intake tube. Position tube to 3" hose and brackets to vibramounts.

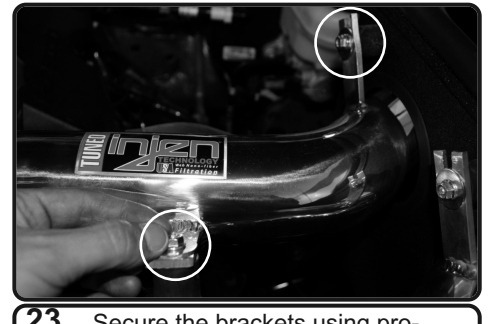

**23.** Secure the brackets using provided M6 nuts and fender washers.

# Instruction Manual P/N:PF9015

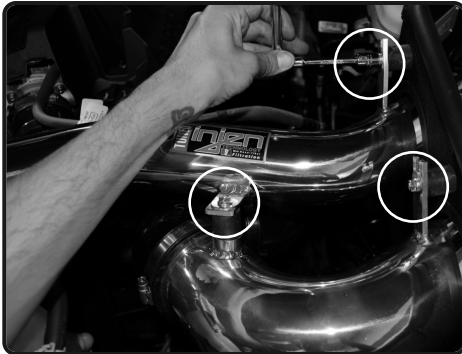

**24.** Tighten all the vibramounts using 10mm socket and ratchet.



**25.** Tighten clamp using 8mm nut driver. For Raptor & 18' F-150, install x-8002 grommet to hole on 3" tube and install temperature sensor. Re-connect the harness to the temperature sensor. *Install the x-6015 grommet to 3.5" tube.*

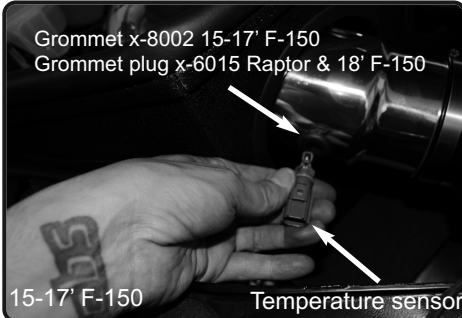

**26.** 15-17' F150 only install grommet x-8002 to the hole on 3.5" tube. Now install the temperature sensor to grommet and secure. Re-connect the harness to the temperature sensor. *Install the x-6015 grommet to 3" tube.*

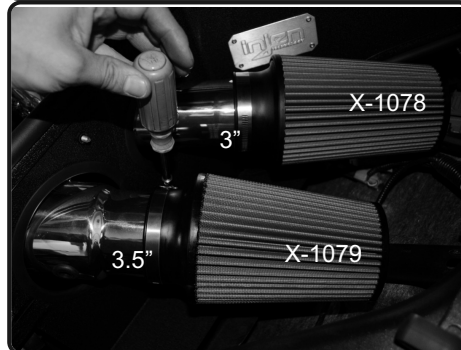

**27.** Install the 1078 filter to the 3" tube. Install the 1079 filter to the 3.5" side of the large tube. Tighten clamps using 8mm nut driver.

Congratulations! You have just completed the installation of this intake system. Periodically, check the alignment of the intake, normal wear and tear can cause nuts and bolts to come loose. **Note: Check clearance and adjust if needed! Failure to check the alignment and adjust the intake can cause damage that will void the warranty. Injen Technology is not responsible for any damages caused by/from improper installation.**

## Test Drive:

1. With the transmission in neutral or park and the parking brake engaged, start the engine. Listen for air leaks or odd noises. If air leaks are detected, secure hoses and connections. For any odd noises, inspect entire system for cause and adjust intake as needed. The Injen intake will function identically to the factory system but will be louder and more powerful.
2. Perform a road test. Listen for odd noises or rattles and fix as necessary.
3. If there are no issues, continue to enjoy your added performance from the Injen performance Intake kit.
4. Injen Technology recommends you periodically check clearance and adjust if needed! Failure to check the alignment and adjust the intake can cause damage that will void the warranty. Injen Technology is not responsible for any damages caused by/from improper installation.

1. Upon completion of the installation, reconnect the negative battery terminal before you start the engine.
2. Align the entire intake system for the best possible fit. Once the intake has been properly fitted continue to tighten all nuts, bolts and clamps.
3. Periodically, recheck the alignment of the intake system and make sure there is proper clearance around and along the length of the intake. Failure to follow proper maintenance procedures may cause damage to the intake and will void the warranty.
4. Start the engine and listen carefully for any odd noises, rattles and/or air leaks prior to taking it for a test drive. If any problems arise go back and check the vacuum lines, hoses and clamps that maybe causing leaks or rattles and correct the problem.
5. Check the filter for excessive dirt build up. Clean or replace the filter with an original Injen filter (can be bought on-line at "injenonline.com"). Congratulations! You have just completed the installation of the best intake system sold on the market. Enjoy the added power and performance of your new intake system.