

MSD INSTALLATION INSTRUCTIONS

MSD-8 Plus Ignition PN 7805

ONLINE PRODUCT REGISTRATION: Register your MSD product online. Registering your product will help if there is ever a warranty issue with your product and helps the MSD R&D team create new products that you ask for! Go to www.msperformance.com/registration.

Note: Solid Core spark plug wires cannot be used with an MSD Ignition.

Parts Included:

1 - MSD-8 Plus Ignition	1 - PN 8830 Filter
1 - Mag Pickup Extension Harness, PN 8860	1 - Coil Harness
4 - Vibration Mounts and Hardware	1 - Power Harness
4 - RPM Modules: 3K, 7K, 8K and 9K	1 - Parts Bag, Mounts, Terminals, etc.

WARNING: Before installing the MSD Distributor, disconnect the battery cables. When disconnecting the battery cables, always remove the Negative (-) cable first and install it last.

FEATURES

SINGLE OR DUAL COIL OUTPUT

The MSD-8 Plus Ignition Control is intended for racing use only. The Ignition has the ability to be used with single or dual coil systems. Note that when using a single coil, both coil positive wires must be connected to the coil.

RPM LIMITERS

The MSD-8 Plus Ignition is equipped with a 2-Step Rev Control. The Ignition will accept two rpm modules so two different rev limits can be set. One rev limit can be used for over-rev protection while the second limit can be activated on the starting line for a lower rpm limit to assist in staging and for consistent holeshots. When 12 volts are applied to the 2-Step terminal (2'S'), Module 1 is active. Module 2 is active when there is no 12 volts.

CYLINDER SELECT

This ignition can be used on 2, 4, 6 (even-fire) or 8-cylinder engines. The ignition is set for 8-cylinder operation. To program the unit for other engines, remove the one screw that holds the cover to reveal three wire loops (Figure 1). Cutting a wire loop determines the cylinder selection.

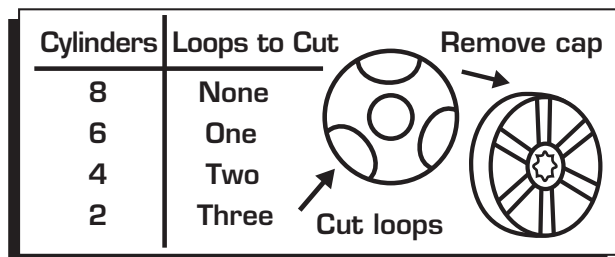

Figure 1 Cylinder Programming.

SPARK LED

When the coil fires, current is sensed and this LED will flash. These LEDs confirm that the ignition has received a trigger signal and that the ignition is working properly. Each time a coil fires, current is sensed and the corresponding LED will flash. (If the coil is not connected, the LED will not flash.) When the engine is running, it will appear solid.

GENERAL INFORMATION

BATTERY

An MSD-8 Plus Ignition Control will operate on any negative ground, 12 volt electrical system with a distributor. The MSD can be used with 16 volt batteries and can withstand a momentary 24 volts in case of jump starts. The Ignitions will deliver full voltage with a supply of 10-18 volts.

If your application does not use an alternator, allow at least 30 amp/hour for every half hour of operation. If the engine is cranked with the same battery or other accessories such as an electric fuel or water pump, the amp/hour rating should be higher.

COILS

The MSD-8 Plus Ignition must be used with an MSD Pro Power Series Coil. The Pro Power HVC, PN 8251, Pro Power HVC II, PN 8261 or for short duration racing, the PN 8201 Pro Power Coil. If you have any questions concerning coils, contact our Customer Service Department at (915) 855-7123.

TACHOMETERS

The MSD Ignition features a Tach Output Terminal on the terminal strip. This terminal provides a trigger signal for tachometers, a shift light or other add-on rpm activated devices. The Tach Output Terminal produces a 12 volt square wave signal with a 20% duty cycle.

SPARK PLUGS AND WIRES

Spark plug wires are very important to the operation of your ignition system. A good quality, helically wound wire and proper routing are required to get the best performance from your ignition, such as the MSD Heli-Core or 8.5mm Super Conductor.

Note: Solid Core spark plug wires cannot be used with an MSD Ignition.

A helically, or spiral wound wire must be used. This style wire provides a good path for the spark to follow while keeping Electro Magnetic Interference (EMI) to a minimum. Excessive EMI, such as the amount that solid core wires produce, will interfere with the operation of the MSD and other electronics on your car.

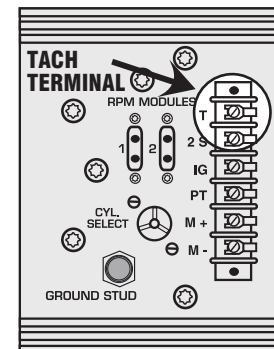

Figure 2 Tach Terminal.

MOUNTING

The MSD can be mounted in most positions. It can be mounted in the engine compartment as long as it is away from direct engine heat sources. It is not recommended to mount the unit in an enclosed area such as the glovebox.

When you find a suitable location to mount the unit, make sure the wires of the ignition reach their connections. Hold the Ignition in place and mark the location of the mounting holes. Use a 1/4" drill bit to drill the holes. Install the vibration mounts to the ignition and mount the unit.

WIRING

GENERAL WIRING INFORMATION

Wire Length: All of the wires of the MSD Ignition may be shortened as long as quality connectors are used or soldered in place. To lengthen the wires, use one size bigger gauge wire (10 gauge for the power leads and 16 gauge for the other wires) with the proper connections. All connections must be soldered and sealed.

Grounds: A poor ground connection can cause many frustrating problems. When a wire is specified to go to ground, it should be connected to the battery negative terminal, engine block or chassis. There should always be a ground strap between the engine and the chassis. Always securely connect the ground wire to a clean, paint free metal surface.

The MSD-8 Plus has a ground stud just to the left of the terminal strip. Use this to ground other MSD accessories (Figure 3).

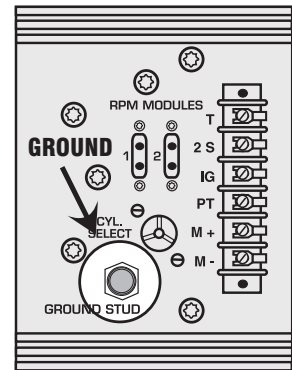

Figure 3 Ground Stud.

Coil Connections: When using a single coil, both coil positive terminals must be connected to the coil. Either connect both orange wires to the coil, or use the supplied jumper to connect the two coil positive terminals at the terminal strip.

Terminal	Wire	Function
COIL 1 +	ORANGE	Connects to the positive (+) terminal of the coil. This is the only wire that makes electrical contact with the coil positive terminal.
COIL 1-	BLACK	Connects to the negative (-) terminal of the coil. This is the only wire that makes electrical contact with the coil negative terminal.
COIL 2 +	ORANGE	Connects to the positive (+) terminal of the second coil. This is the only wire that makes electrical contact with the coil positive terminal.
COIL 2-	BLACK	Connects to the negative (-) terminal of the second coil. This is the only wire that makes electrical contact with the coil negative terminal.
BAT -	HEAVY BLACK	This wire connects to a good ground, either at the battery negative (-) terminal or to the engine.
BAT +	HEAVY RED	This wire connects directly to the battery positive (+) terminal or to a positive battery junction or the positive side of the starter solenoid. Note: Never connect to the alternator.
TACH	GRAY	This terminal delivers a 12 volt square wave signal as an output for a tachometer or devices that require an rpm signal.
2-STEP	DARK BLUE	When this terminal is connected to 12 volts, RPM module 1 is active. When there is no 12 volts, RPM module 2 is active.
IGNITION	RED	Connects to a switched 12 volt source. Such as the ignition key or switch.
POINTS	WHITE	This wire is used to connect to the points, electronic ignition amplifier output or to the Yellow wire of an MSD Timing Accessory. When this wire is used, the Magnetic Pickup connector is not used.
MAG + MAG -	VIOLET GREEN	These wires are routed together in one harness from the Magnetic Pickup connector. The connector plugs directly into an MSD Distributor or Crank Trigger. It will also connect to factory magnetic pickups or other aftermarket pickups (Figure 4). The Violet wire is pos. (+) and the Green is neg. (-). When these wires are used, the Points Terminal is not.

ROUTING WIRES

The MSD wires should be routed away from direct heat sources such as exhaust manifolds and headers and any sharp edges. The trigger wires should be routed separate from the other wires and spark plug wires. It is best if they are routed along a ground plane such as the block or firewall which creates an electrical shield. The magnetic pickup wires should always be routed separately and should be twisted together to help reduce extraneous interference (the harness supplied is already twisted).

The chart shows the polarity of other common magnetic pickups. If using a different magnetic pickup, use the MSD 2-Pin connector, available as PN 8824, for a direct plug-in installation.

WARNING: The MSD-8-Series Ignitions are capacitive discharge ignitions. High voltage is present at the coil primary terminals. Do not touch the coil or connect test equipment to the terminals.

Common Mag Pickup Wires		
Distributor	Colors	
	Mag+	Mag-
MSD	Org/Blk	Vio/Blk
MSD Crank Trigger	Org/Blk	Vio/Blk
Ford	Orange	Purple
Accel ^{46/48000} Series	Org/Blk	Vio/Blk
Accel ^{51/61000} Series	Red	Black
Chrysler	Org/Wht	Black
Mallory	Org/Blk	Vio/Blk

Figure 4 Common Mag Pickup Wires.

PRESTART CHECK LIST

- The only wires connected to the coil terminals are the MSD Orange to coil positive and Black to coil negative.
- The small Red wire of the MSD is connected to a switched 12 volt source.
- The MSD power leads are connected directly to the battery positive and negative terminals.
- The battery is connected and fully charged if not using an alternator.
- The engine is equipped with at least one ground strap to the chassis.

TROUBLESHOOTING

Every MSD Ignition undergoes numerous quality control checks including a four hour burn-in test. If you experience a problem with your MSD, our research has shown that the majority of problems are due to improper installation or poor connections.

The Troubleshooting section has several checks and tests you can perform to ensure proper installation and operation of the MSD. If you have any questions concerning your MSD, call our Customer Support Department at (915) 855-7123, 7 - 6 mountain time.

MISSES AND INTERMITTENT PROBLEMS

Experience at the races has shown that if your engine is experiencing a miss or hesitation at higher rpm, it is usually not directly ignition related. Most probable causes include a coil or plug wire failure, arcing from the cap or boot plug to ground or spark ionization inside the cap. Several items to inspect are:

- Always inspect the plug wires at the cap and at the plug for a tight connection and visually inspect for cuts, abrasions or burns.
- Inspect the Primary Coil Wire connections. Because the MSD is a Capacitive Discharge ignition and it receives a direct 12 volt source from the battery, there will not be any voltage at the Coil Positive (+) terminal even with the key turned On. During cranking or while the engine is running, very high voltage will be present and no test equipment should be connected.
- Make sure that the battery is fully charged and the connections are clean and tight. If you are not running an alternator this is an imperative check. If the battery voltage falls below 10 volts during a race, the MSD output voltage will drop.

WARNING: Do not touch the coil terminals during cranking or while the engine is running.

- Is the engine running lean or excessively rich? Inspect the spark plugs and fuel system.
- Inspect all wiring connections for corrosion or damage. Remember to always use proper connections followed by soldering and seal the connections completely.

LED: The LED on the ignition will assist in troubleshooting. If the LED does not flash, there is no current through the primary coil wires. This could be due to poor connections at the coil, the coil itself or the ignition. Once you confirm that the trigger signal is working, try a different coil. See below to test for spark.

If everything checks positive, use the following procedure to test for spark. MSD also offers an Ignition Tester, PN 8998. This tool allows you to check your complete ignition system while it is in the car as well as the operation of rpm limits, activated switches and shift lights.

CHECKING FOR SPARK

If triggering the ignition with the White wire:

1. Make sure the ignition switch is in the "Off" position.
2. Remove the coil wire from the distributor cap and set the terminal approximately 1/2" from ground.
3. Disconnect the MSD White wire from the distributor's points or ignition amplifier.
4. Turn the ignition to the "On" position. Do not crank the engine.
5. Rapidly tap the White wire to ground **several times** (the first 3-4 times will not spark). When the wire is pulled from ground, a spark should jump from the coil wire to ground. If spark is present, the ignition is working properly. If there is no spark skip to step 6 on page 6:

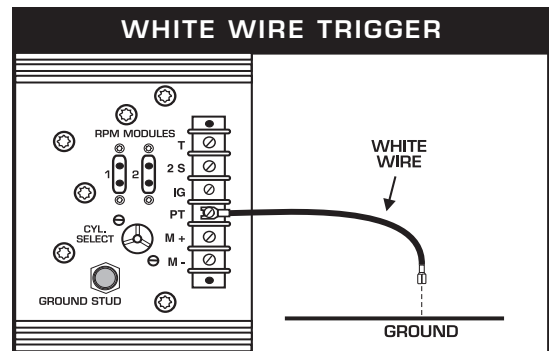

Figure 5 Checking for Spark with a White Wire.

If triggering with the Magnetic Pickup:

1. Make sure the ignition switch is in the "Off" position.
2. Remove the coil wire from the distributor cap and set the terminal approximately 1/2" from ground.
3. Disconnect the MSD magnetic pickup wires from the distributor.
4. Turn the ignition to the "On" position. Do not crank the engine.
5. With a small jumper wire, short the MSD's Green and Violet magnetic pickup wires together several times (the first 3-4 times will not spark). Each time you break this ground (rapidly), a spark should jump from the coil wire to ground. If spark is present, the ignition is working properly. If there is no spark skip to step 6 on page 6.

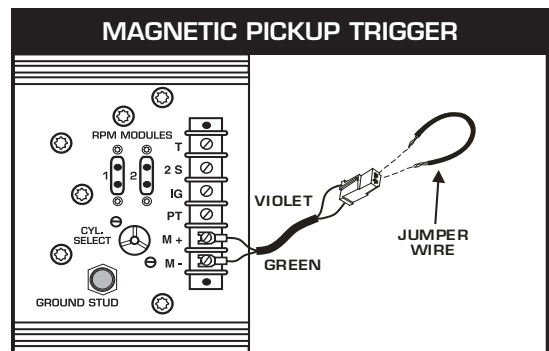

Figure 6 Checking for Spark with Magnetic Pickup.

6. If there is no spark:

- A. Inspect all of the wiring.
- B. Substitute another coil and repeat the test. If there is now spark, the coil is at fault.
- C. If there is still no spark, check to make sure there is 12 volts on the small Red wire from the MSD when the key is in the "On" position. If 12 volts is not present, find another switched 12 volt source and repeat the test.
- D. If, after following the test procedures and inspecting all of the wiring, there is still no spark, the MSD Ignition is in need of repair. See the Warranty and Service section for information.

If there is no spark, but the LED flashes, check for a coil problem.

The following wiring diagrams illustrate numerous installations on different vehicles and applications. If you experience difficulties when installing your MSD, contact our Customer Support Department at (915) 855-7123 (7 - 6 Mountain time) or e-mail us at: msdtech@msdignition.com

COIL TERMINALS

MSD supplies heavy duty, nickel plated terminals for the connections. There is also a piece of heat-shrink sleeve to cover the wire crimp.

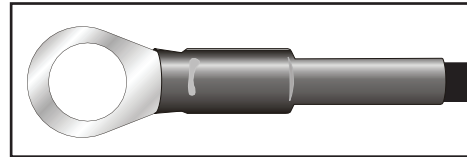
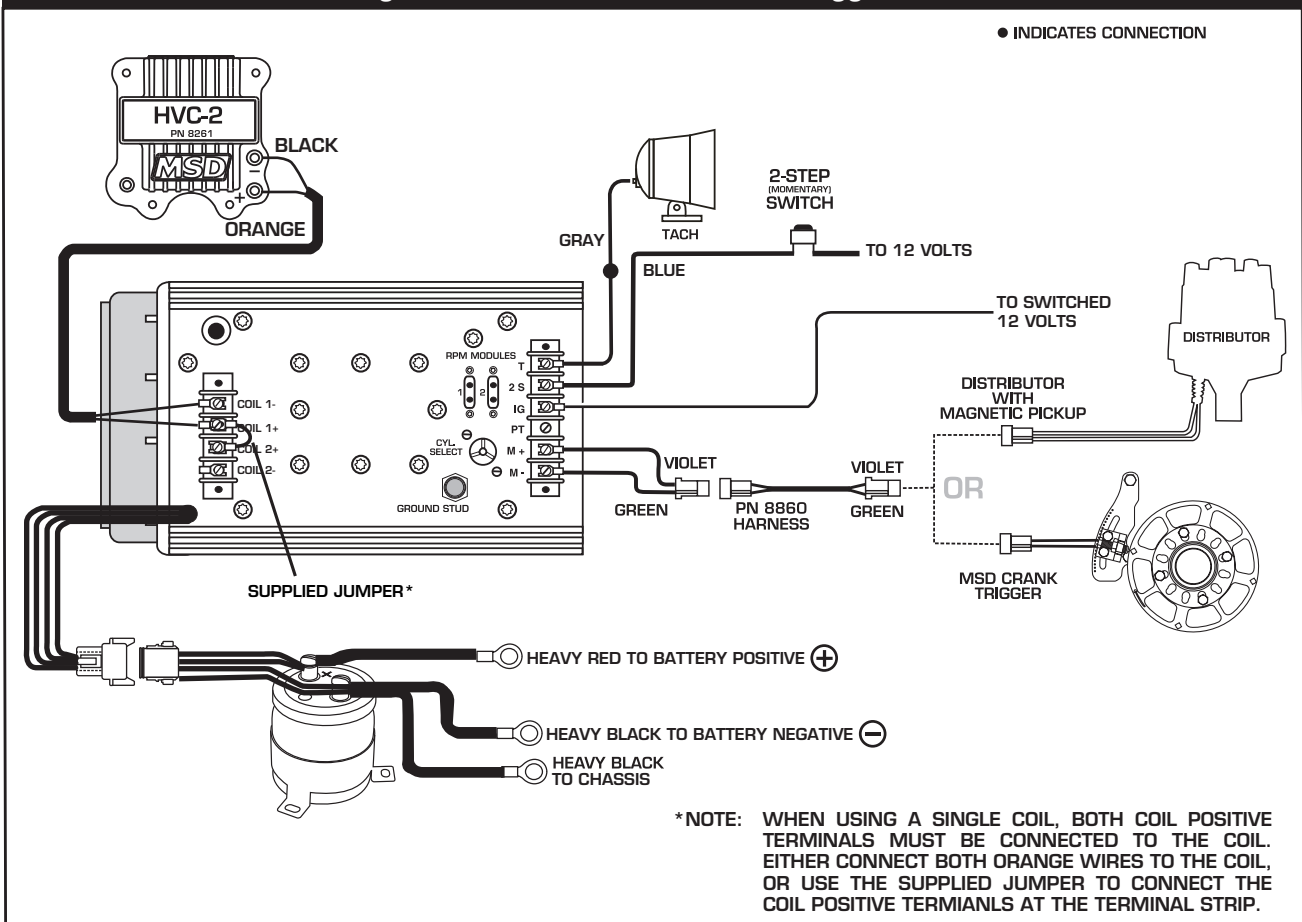
**MSD SYSTEMS Installing to an MSD Distributor/Crank Trigger.**

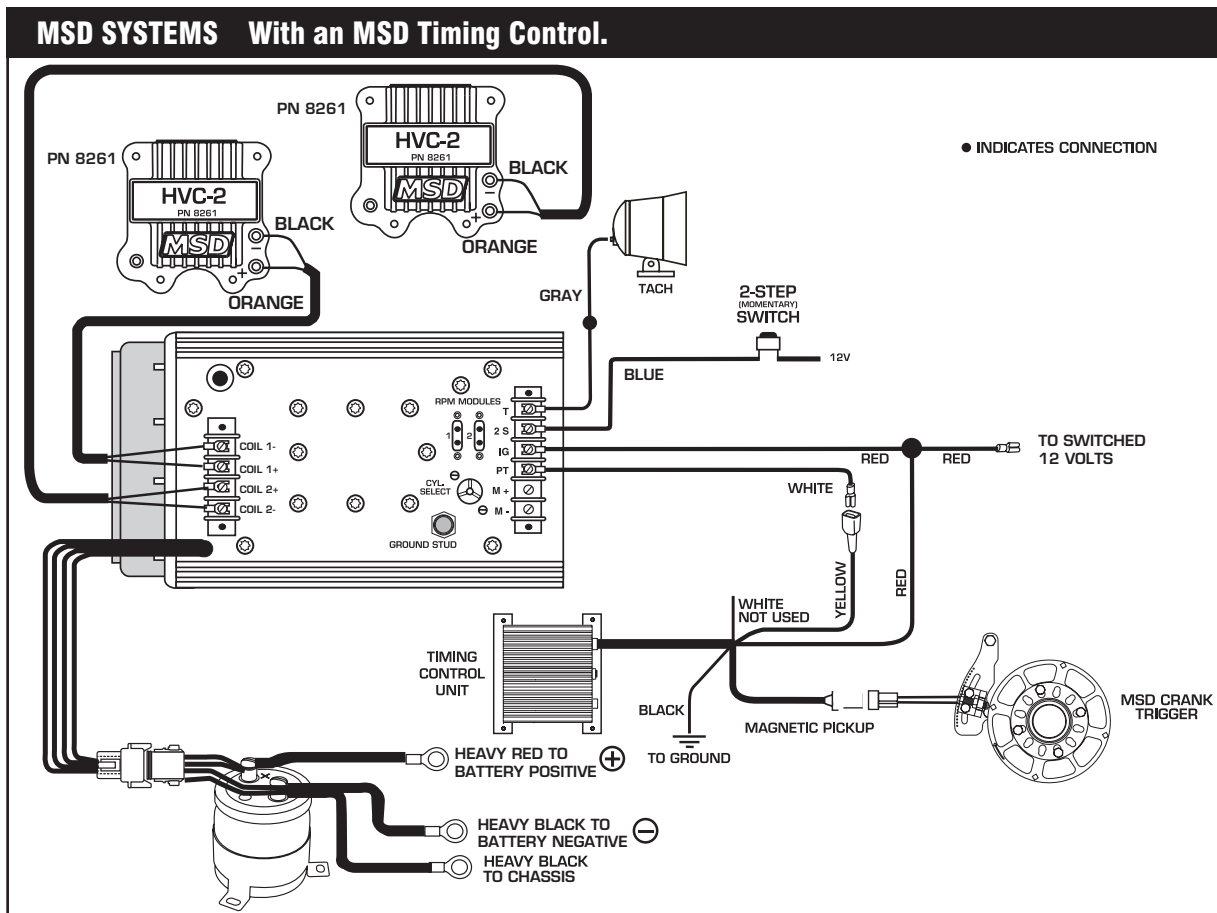
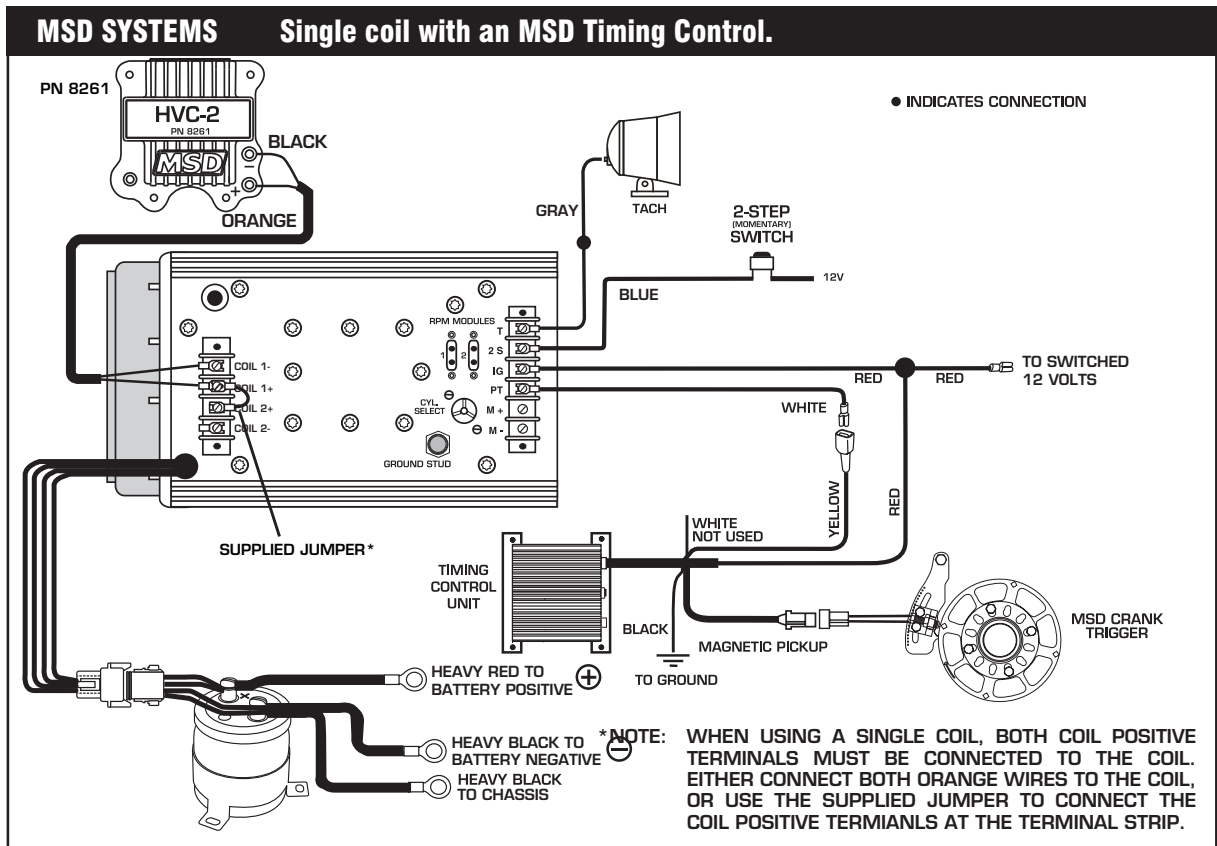

MSD SYSTEM Installing to a Programmable Digital 7, PN 7531

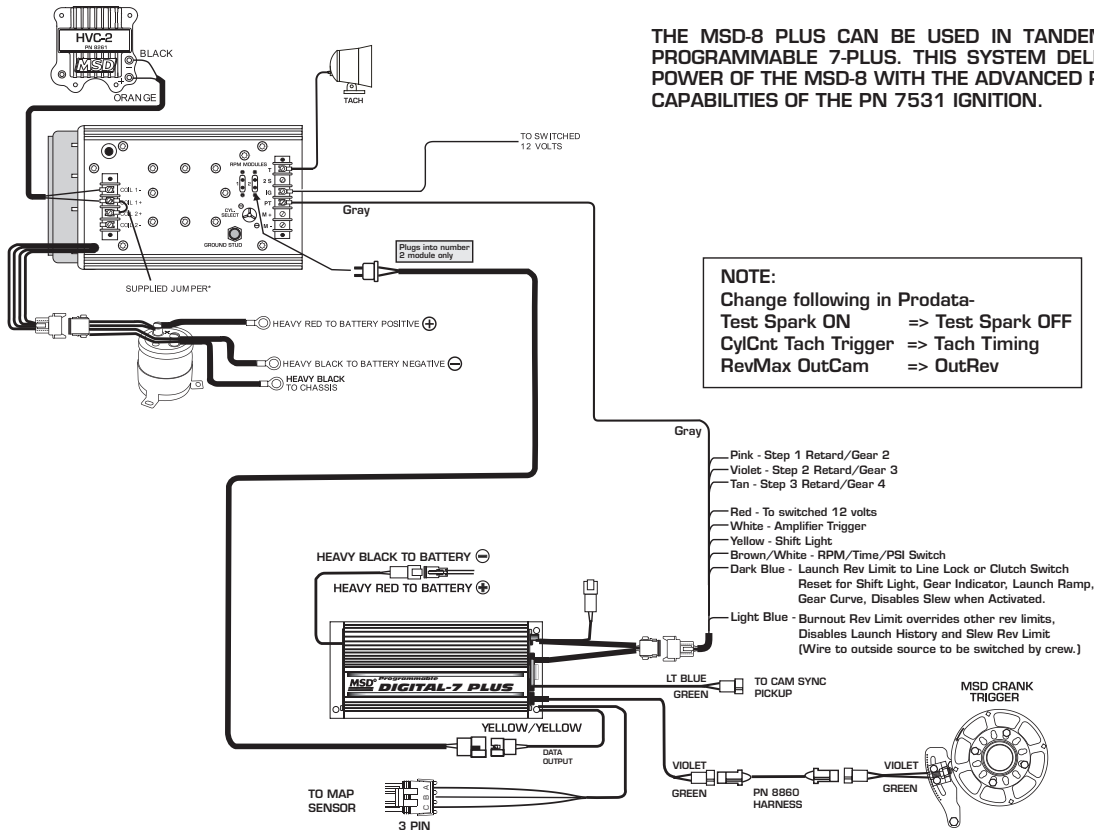

Service

In case of malfunction, this MSD component will be repaired free of charge according to the terms of the warranty. When returning MSD components for warranty service, **Proof of Purchase** must be supplied for verification. After the warranty period has expired, repair service is based on a minimum and maximum fee.

All returns must have a Return Material Authorization (RMA) number issued to them before being returned. To obtain an RMA number please contact MSD Customer Service at 1 (888) MSD-7859 or visit our website at www.msdpower.com/rma to automatically obtain a number and shipping information.

When returning the unit for repair, leave all wires at the length in which you have them installed. Be sure to include a detailed account of any problems experienced, and what components and accessories are installed on the vehicle. The repaired unit will be returned as soon as possible using Ground shipping methods (ground shipping is covered by warranty). For more information, call MSD at (915) 855-7123. MSD technicians are available from 7:00 a.m. to 5:00 p.m. Monday - Friday (mountain time).

Limited Warranty

MSD warrants this product to be free from defects in material and workmanship under its intended normal use*, when properly installed and purchased from an authorized MSD dealer, for a period of one year from the date of the original purchase. This warranty is void for any products purchased through auction websites. If found to be defective as mentioned above, it will be repaired or replaced at the option of MSD. Any item that is covered under this warranty will be returned free of charge using Ground shipping methods.

This shall constitute the sole remedy of the purchaser and the sole liability of MSD. To the extent permitted by law, the foregoing is exclusive and in lieu of all other warranties or representation whether expressed or implied, including any implied warranty of merchantability or fitness. In no event shall MSD or its suppliers be liable for special or consequential damages.

*Intended normal use means that this item is being used as was originally intended and for the original application as sold by MSD. Any modifications to this item or if it is used on an application other than what MSD markets the product, the warranty will be void. It is the sole responsibility of the customer to determine that this item will work for the application they are intending. MSD will accept no liability for custom applications.