



Thank you for being selective enough to choose a Dinan Performance Intake System. The Dinan engineering team has spent many hours developing this product to assure that you will receive increased performance, durability and an aesthetic design that you as a customer will be able to enjoy for many years. Ease of installation and maintenance is important to us and has been highly considered throughout the design process.

Prior to performing the installation, familiarize yourself with these instructions as it should help you with the process. If you feel that you do not have the required skills or tools, please arrange for a qualified repair facility to perform the installation.

If you have any difficulties during the installation or if these instructions are not clear to you, please call Dinan's Technical Support Staff at (800) 341-5480.

Refer to BMW factory recommended procedure for further details.

Again, thank you for choosing Dinan. Enjoy.

## Installation Instructions

### **D760-0059: COLD AIR INTAKE SYSTEM**

**Document Revision:** A  
**Release Date:** December 2, 2021

**Vehicle List:**  
G22/G23 430i (2021+)  
G26 430i (2022+)  
G20 330i (2019+)

### **Table of Contents**

Parts List .....	2
Tools Required.....	2
Removing the Stock Intake System .....	3
Assembling the Dinan Intake System .....	5
Installing the Dinan Intake System .....	6
Enjoy .....	8

## Parts List

\*\*Model view may not represent actual look of part. For reference only\*\*

ITEM NO.	PartNo	DESCRIPTION	QTY.
1	#48Z	Clamp, 9mm, 80-100	2
2	D340-0432	SILICONE HOSE	1
3	D401-0027	Air Filter, G20	1
4	D671-0143	M4x16x0.7P Button Head, SS	3
5	D671-0147	M4 x 10 x 0.7P Button Head, SS	2
6	D671-0236	Rivet, Pushin Click Lock, 0.161", Nylon Black	5
7	D671-0244	Rivet, Push in Ribbed, 0.25in, BLK	3
8	D762-0270	Airbox Lid, G2x	1
9	D763-0169	Assy, Intake Tube, G20 B46	1
10	D763-0179	Assy, Lower Airbox, G20 B46	1
11	M4 NYLOK	M4x0.7P Nylok Nut	3
12	M4X12 FENDER	M4 WASHER	6

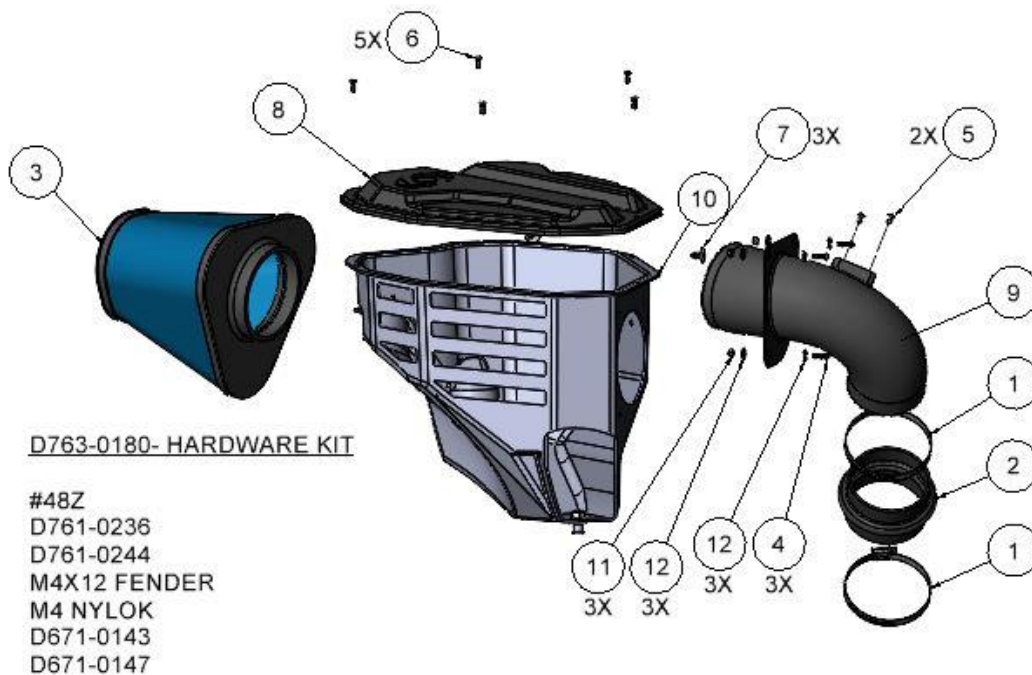

## Tools Required

- 6mm Socket
- 7mm Socket
- 8mm Socket
- Long extension for sockets
- 2.5mm Hex Key
- 3mm Hex Key
- T20 Torx Bit

## Removing the Stock Intake System

- 1) If equipped, remove the brace to access the stock intake system. Hardware will be re-used.

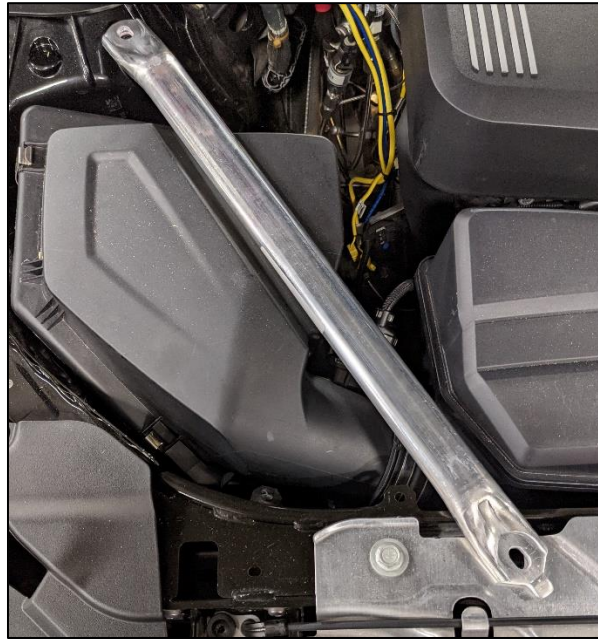

- 2) Remove the stock intake system from the car.
  - 1) Unplug the Air Temperature Sensor.
  - 2) Loosen the hose clamp attached to the inlet tube.
  - 3) Pull straight up to remove the intake from the car.

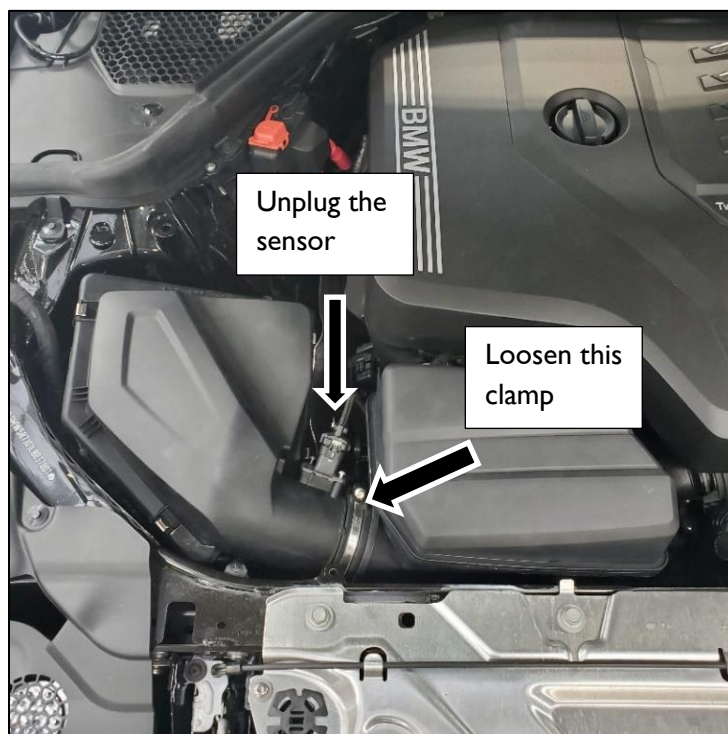

3) Remove the air temperature sensor from the stock intake and carefully place it to the side.

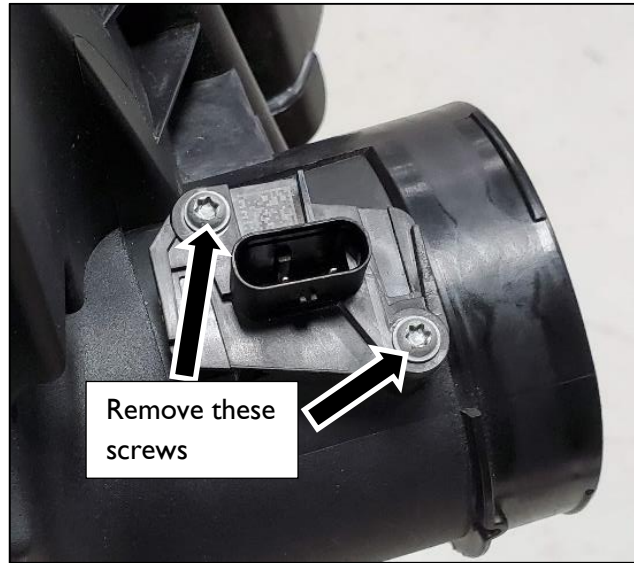

4) Remove the stock inlet tube.

- Cut the lower crimp clamp on the inlet tube.
- Remove the inlet tube.
- **WARNING** – The turbocharger inlet is now exposed. Items that fall inside can cause severe damage to the turbo! Be sure to place a rag or towel in the inlet to protect the turbo.

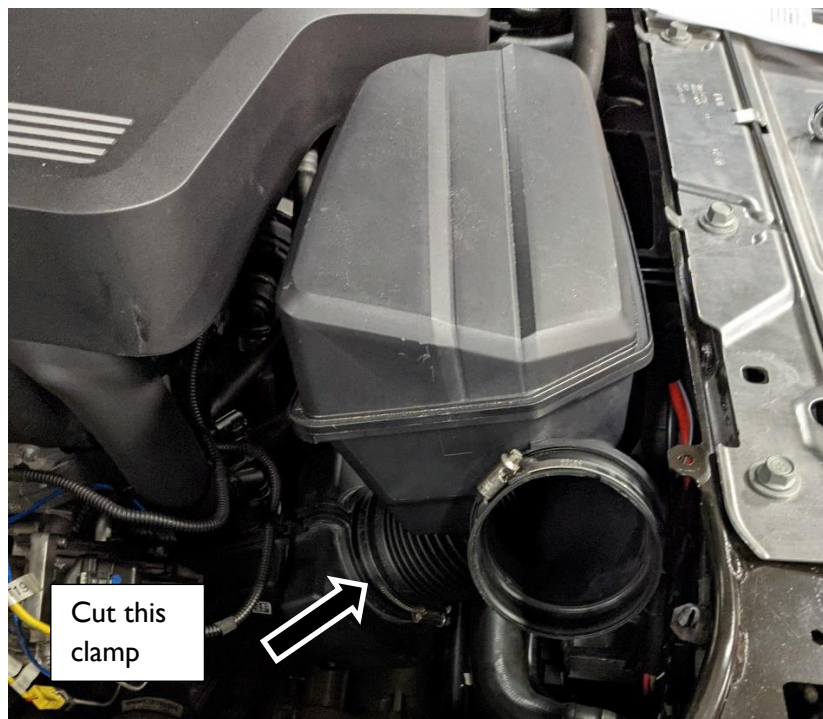

## Assembling the Dinan Intake System

1) Attach the intake tube to the lower box using the hardware shown below. Tighten

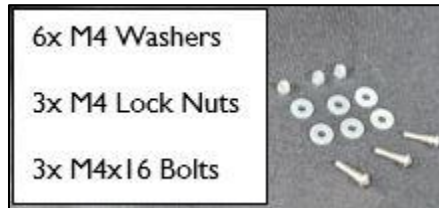

2) Air Filter Installation

1. Ensure the correct orientation of the filter during assembly. The “DINAN EGG” Logo on the end of the filter shall be upright and the filter shall not protrude above the lower box top lip.
2. Once the filter is properly seated on the intake tube, tighten the clamp.



Figure 1: Filter Installation

- 3) Install the air temperature sensor into the Inlet Tube with the provided M4x10 screws (2).
- 4) Press fit the plastic ribbed rivets into the 3 openings on side of box as shown below.

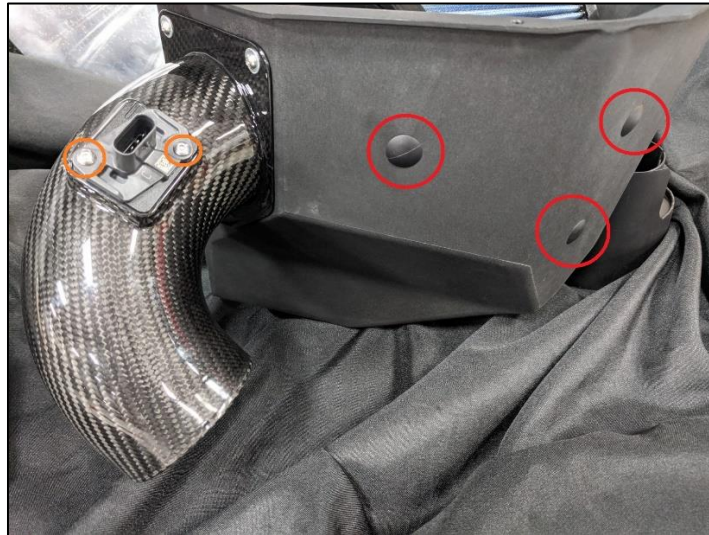

### Installing the Dinan Intake System

- 1) Fully seat the Silicone Hose with supplied 48Z clamp to the turbocharger inlet collar, as shown below.
- 2) Tighten the clamp.

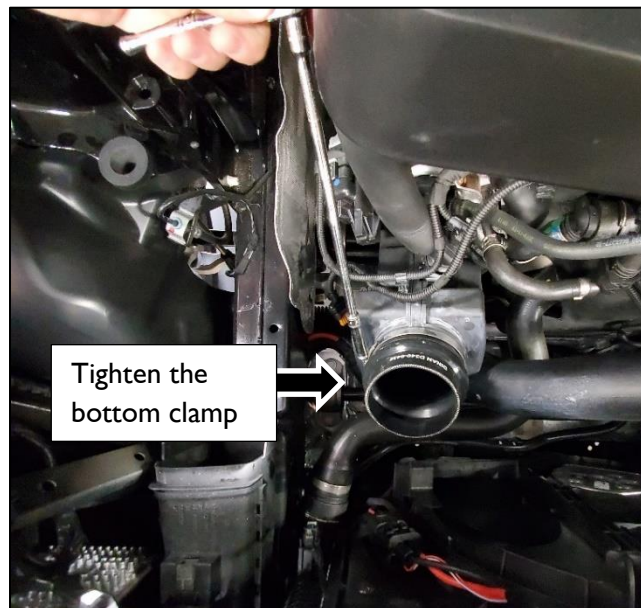

- 3) Fully loosen the remaining clamp and slide onto the top of the Silicone Hose.
- 4) Seating the Intake Assembly
  - a. Lower the box assembly and feed the Intake Tube into the hose.
  - b. The lower box will snap into the 3 rubber grommets on the vehicle.
  - c. Ensure unit is seated properly and tighten the top hose clamp.



- 5) Attach the intake lid to the airbox using the push rivets. Extras are supplied.
- 6) **Reconnect the vehicle sensor.**

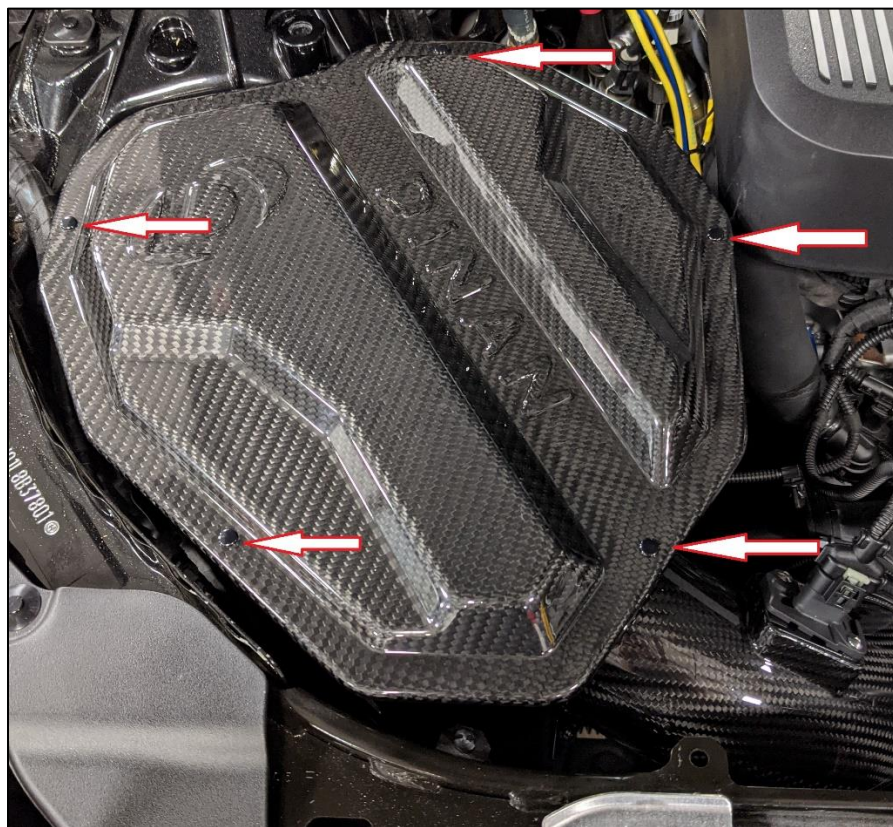

- 7) Re-install the brace.
  - a. For a proper lid spacing, install the spacer under the front mounting hole prior to tightening.
  - b. Torque to 65 Nm.
  - c. Repeat this operation on the other side for symmetry.



## Enjoy

Installation is now complete. Clean the carbon fiber with a microfiber cloth and ensure all tools are removed from engine compartment prior to closing the hood.